

80212

k'nex

500PC BUILDING SET

ALTERNATE BUILDS

Castle
page 1



Tower Crane
page 13



Windmill
page 29



Race Track
page 45



Castle

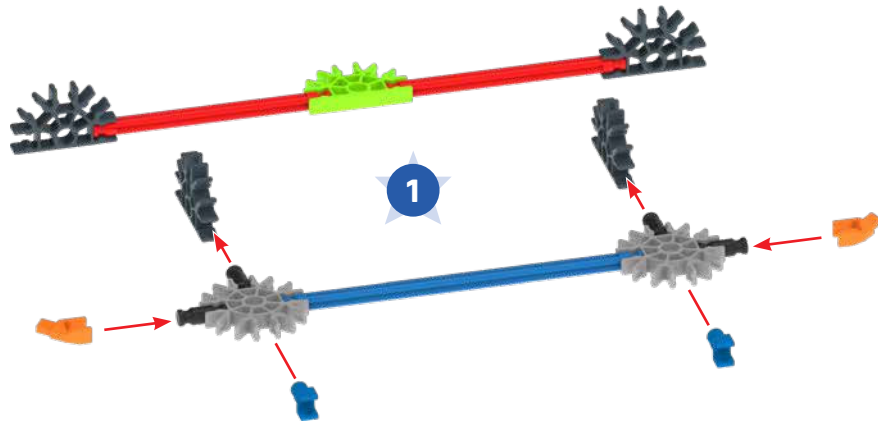

4	2	2	1
90960	91690	909142	909064
2	909533		4
			909062
1	92954		2
			909081

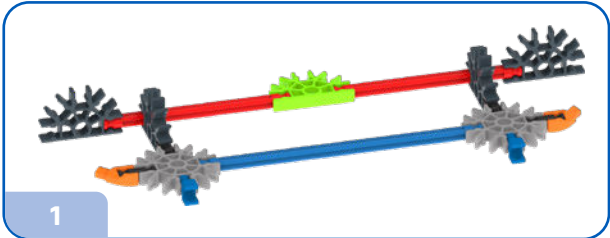

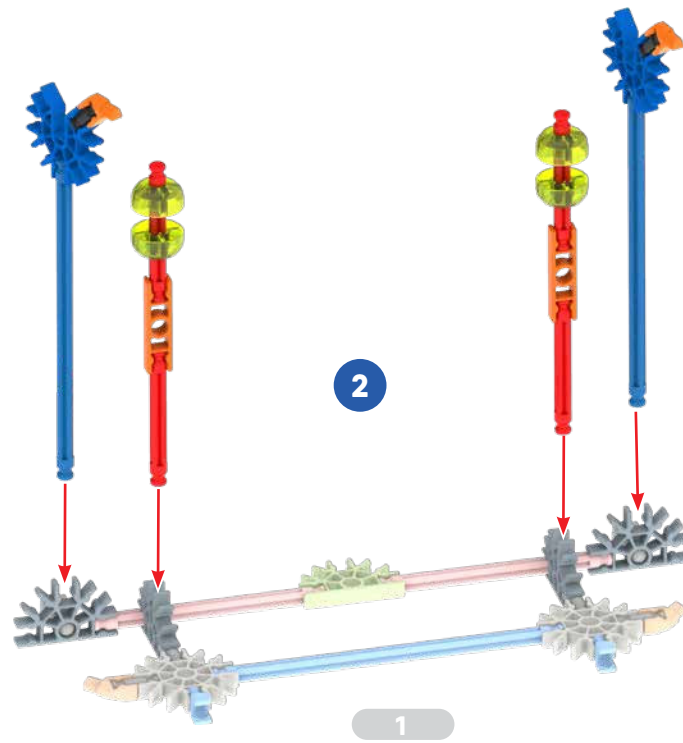

2		2	
	90960		91690
2		4	
	90902		91921
4		2	
	909524		909074
2			
			92954

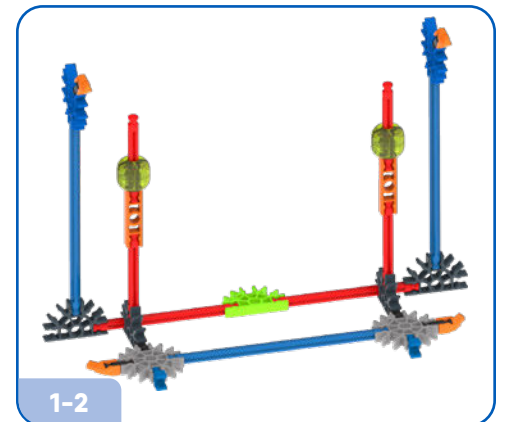

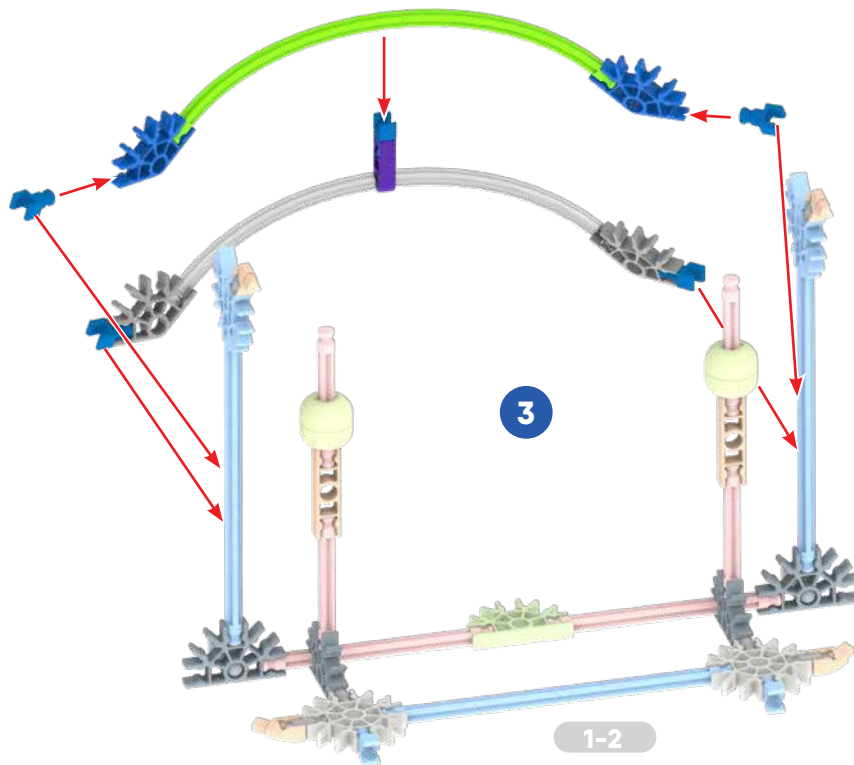

5	1	2	2
909142	909011	909055	909056
1			
			91100
1			
			91108

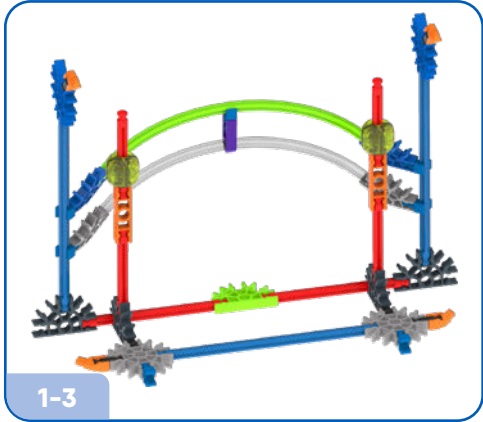

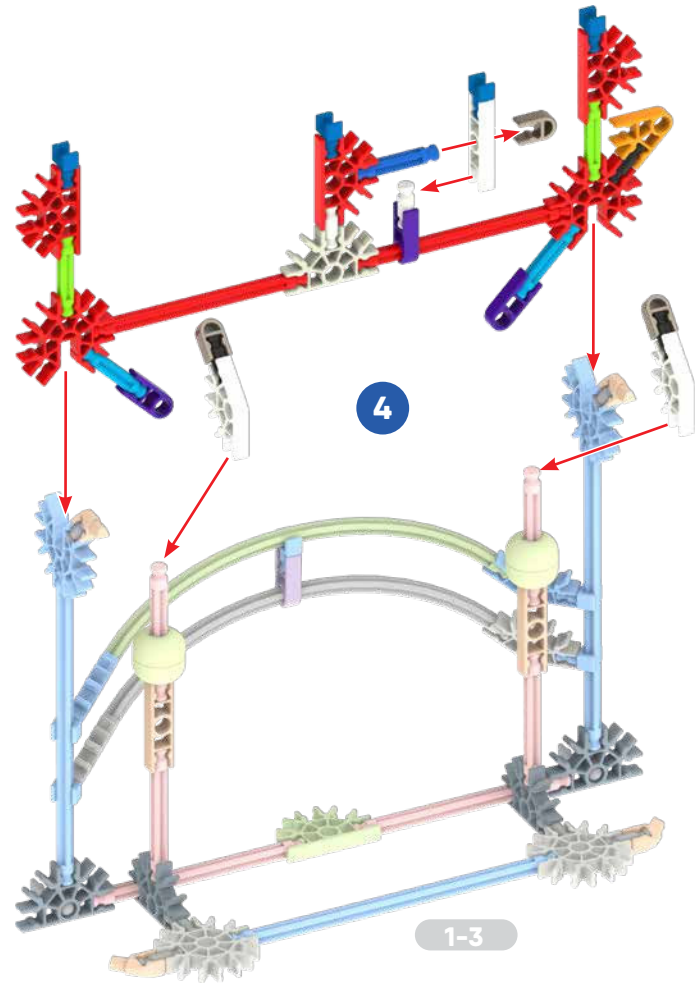

4 909142	2 909503	2 90960	3 914401	3 909011	1 909023
2 909512	1 909513	1 91903	2 909059		
2 914801			1 90949	3 909065	2 909076
2 909533					

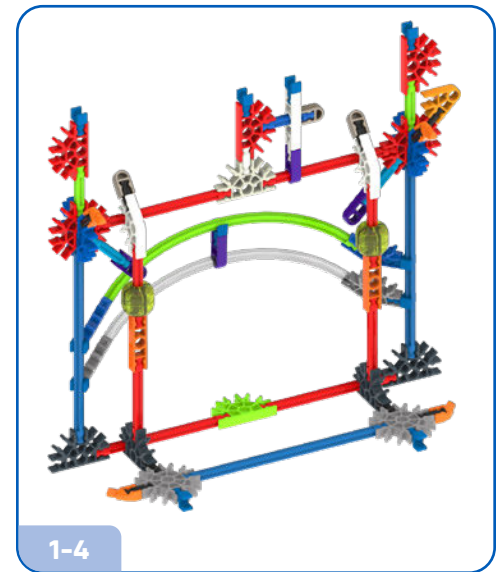

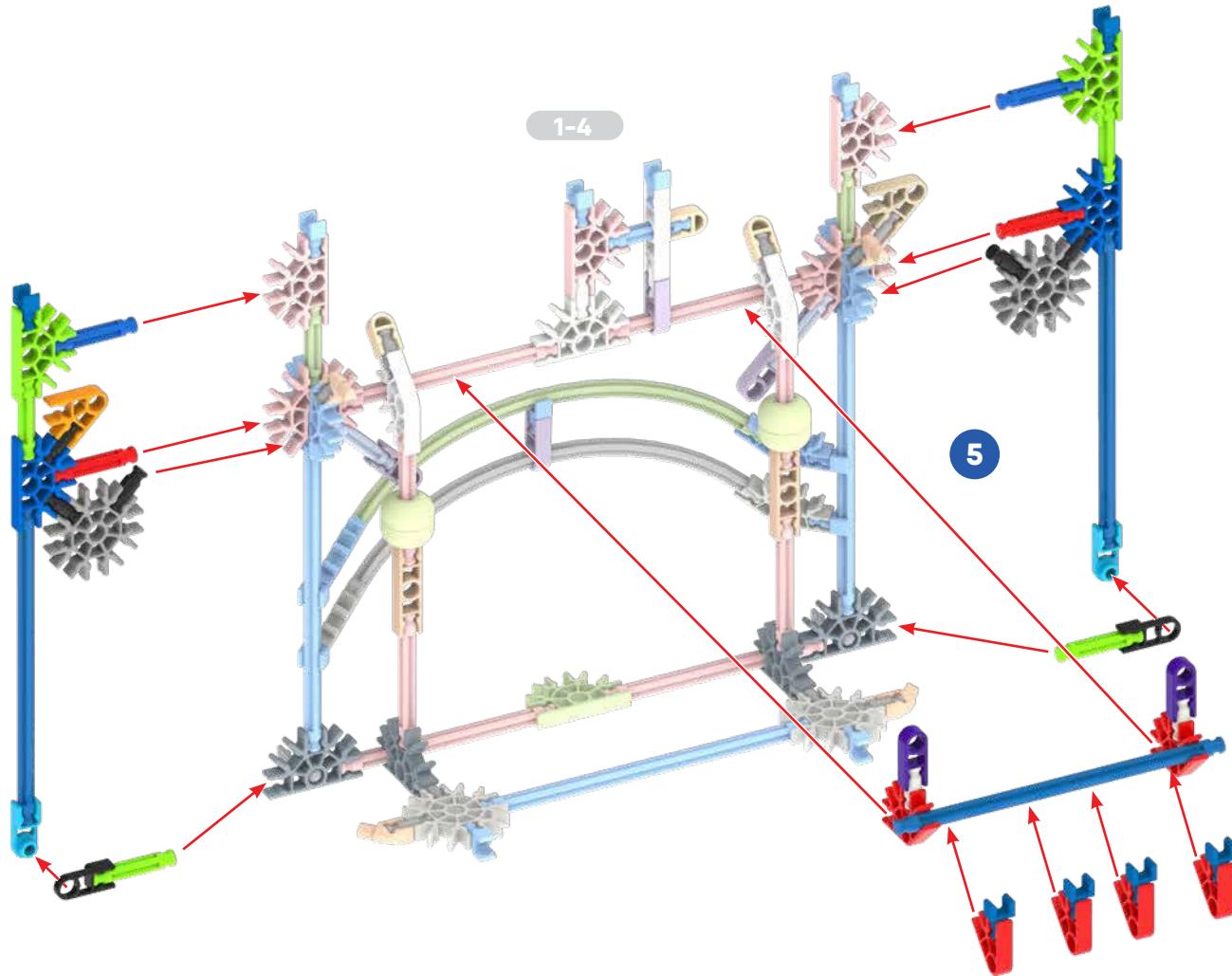

- | | | | | |
|-------------|-------------|-------------|-------------|-------------|
| 2
909011 | 2
90919 | 2
90912 | 4
909032 | 2
909057 |
| 5
90960 | 2
909503 | 6
909142 | 1
91903 | 2
909081 |
| 4
909512 | 2
909513 | 2
909514 | 2
909063 | 2
909064 |
| 3
92954 | | | | |

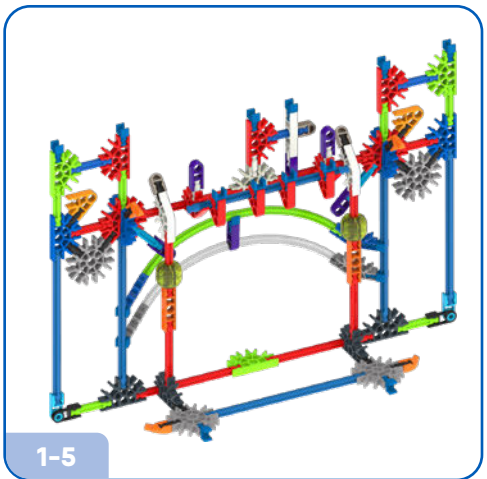

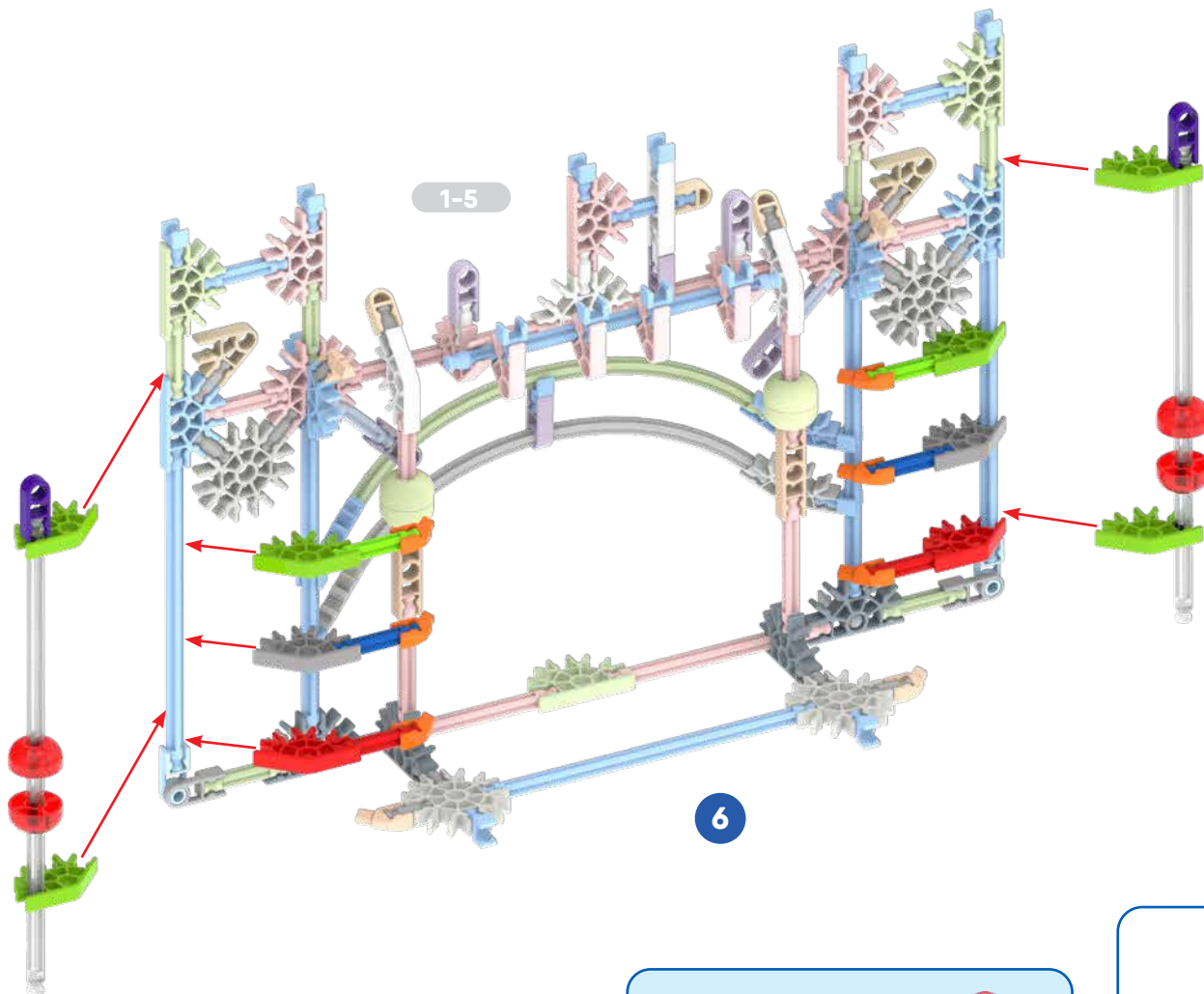

6

- | | | | | | | | |
|---|--------|---|--------|---|--------|---|--------|
| 2 | | 6 | | 2 | | 4 | |
| | 909514 | | 91690 | | 909011 | | 91920 |
| 2 | | 6 | | 2 | | 2 | |
| | 909513 | | 909053 | | 909055 | | 909057 |
| 2 | | | | | | | |
| | 909512 | | | | | | |
| 2 | | | | | | | |
| | | | | | | | 91100 |

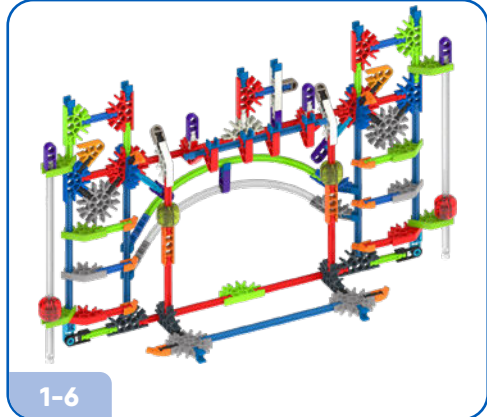

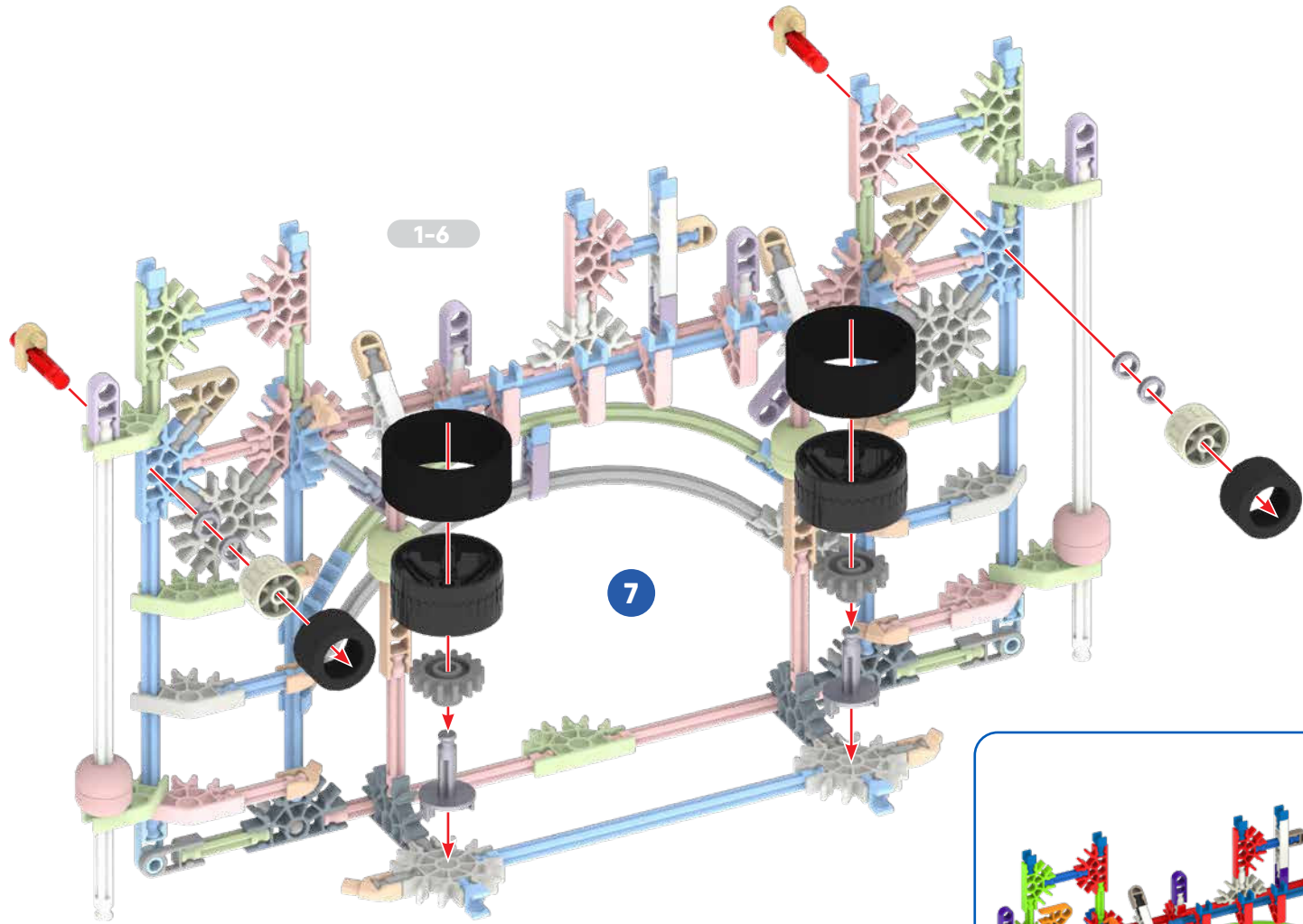

- | | | |
|-------------|-------------|------------|
| 4
91994 | 2
90988 | 2
91170 |
| 2
90900 | 2
531204 | 2
91380 |
| 2
909514 | 2
845100 | |
| 2
91620 | | |

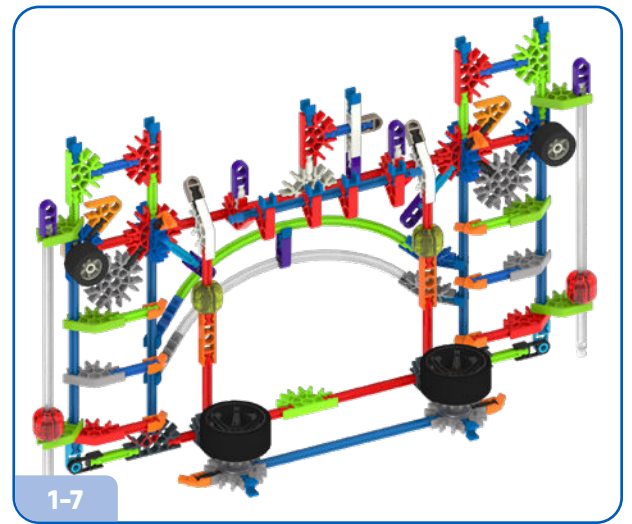

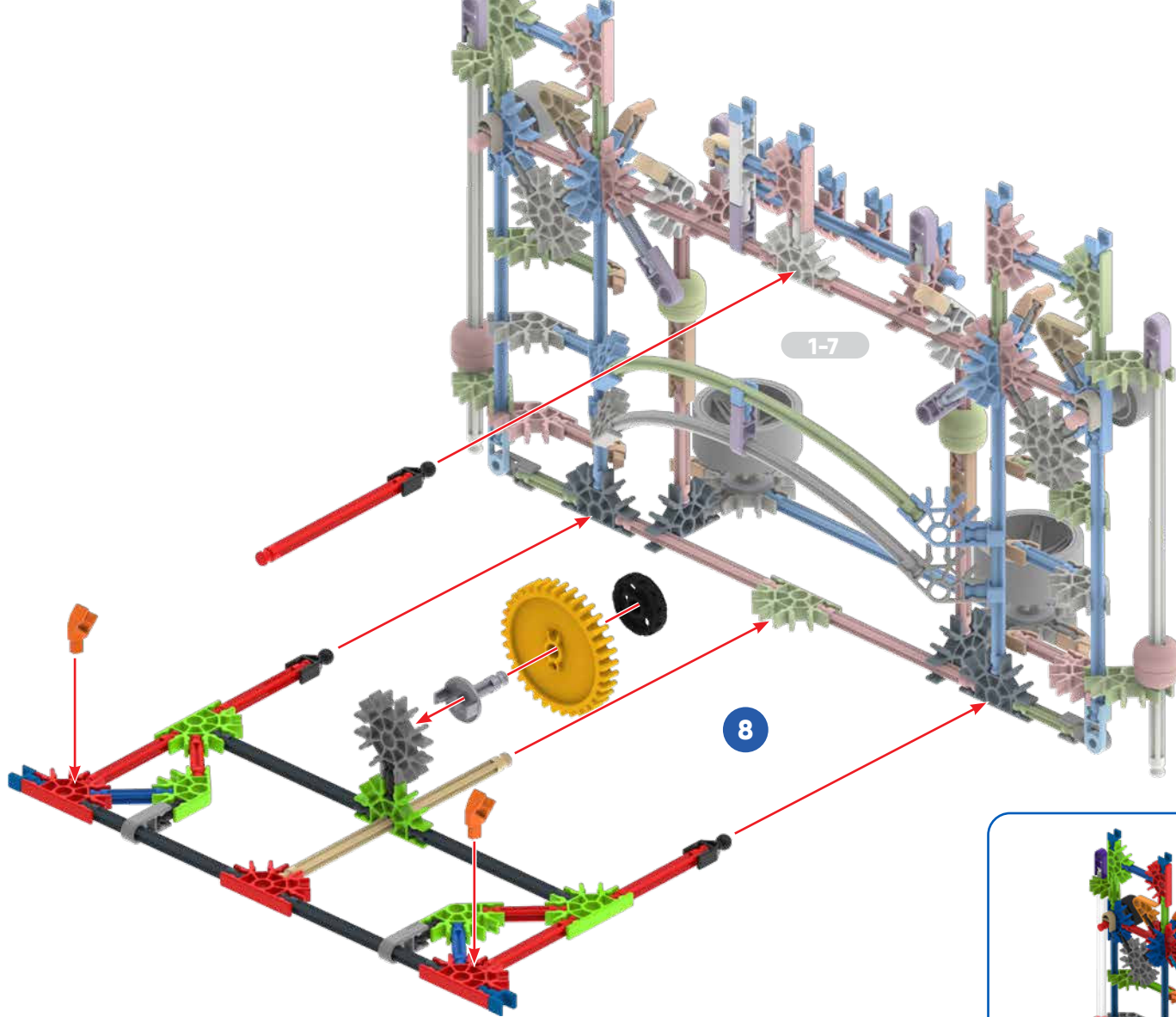

2	909514	3	90960	2	91690	2	909142	3	90940
2	909513	2	909012	1	91620	1	918300		
4	909524							3	909065
1	909533	2	909054	3	909064				
4	909532			1	909081	1	90993		
1	90957								



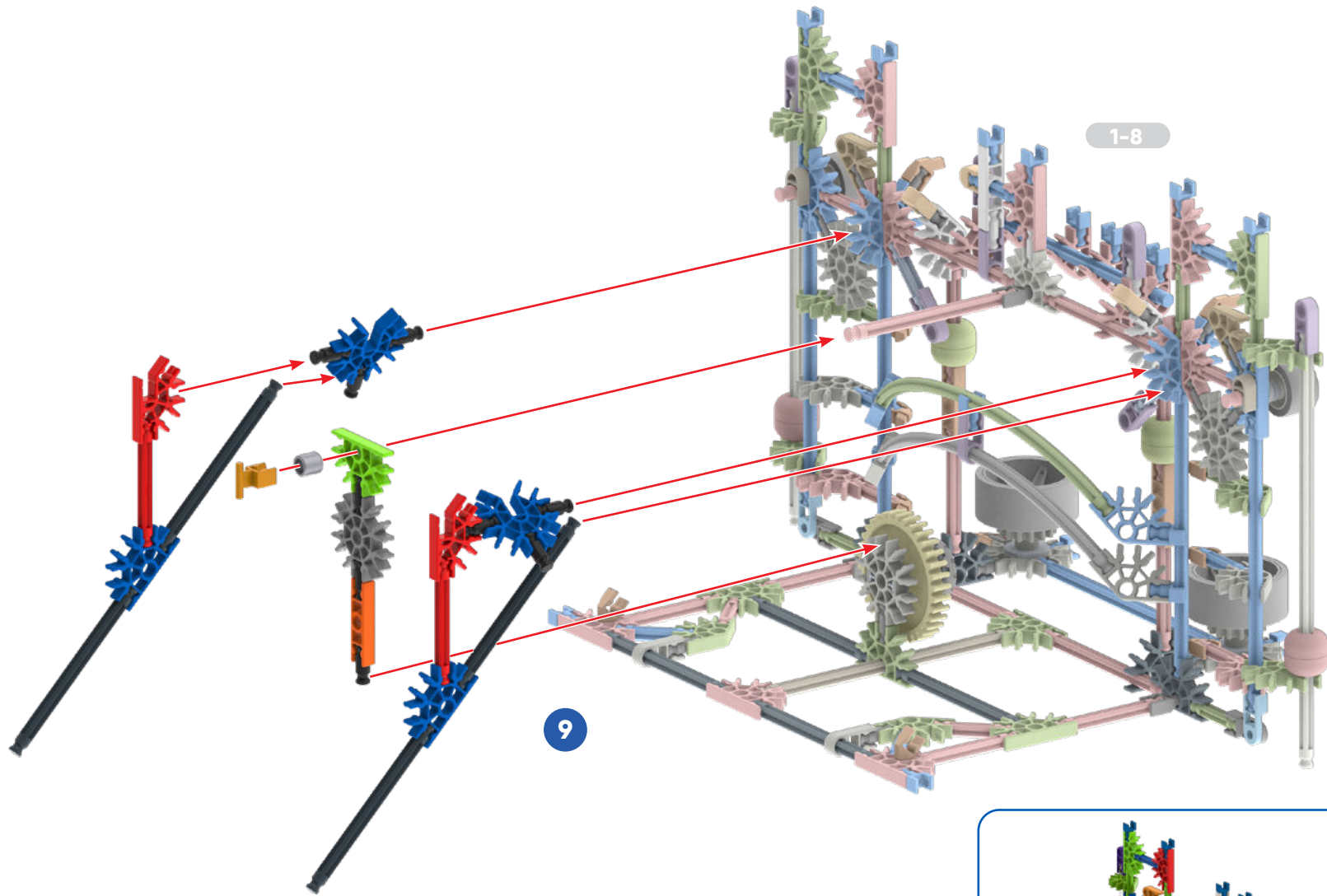

9

1-8

1	91224	1	90902	2	909063	1	909064
9	90960	1	90911	2	909093	2	909081
2	909524			2	909074		
4	909532						

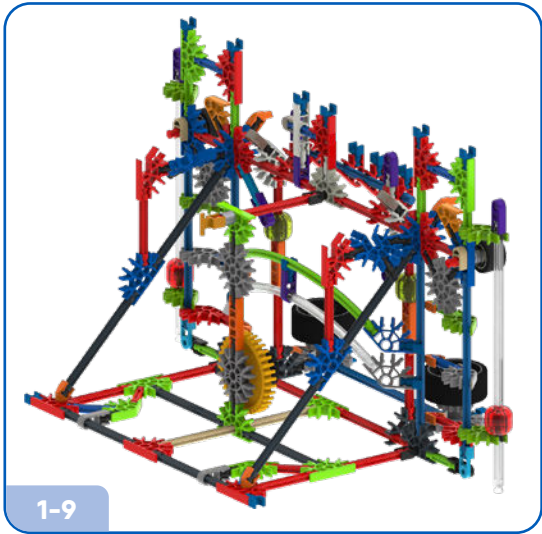

1-9

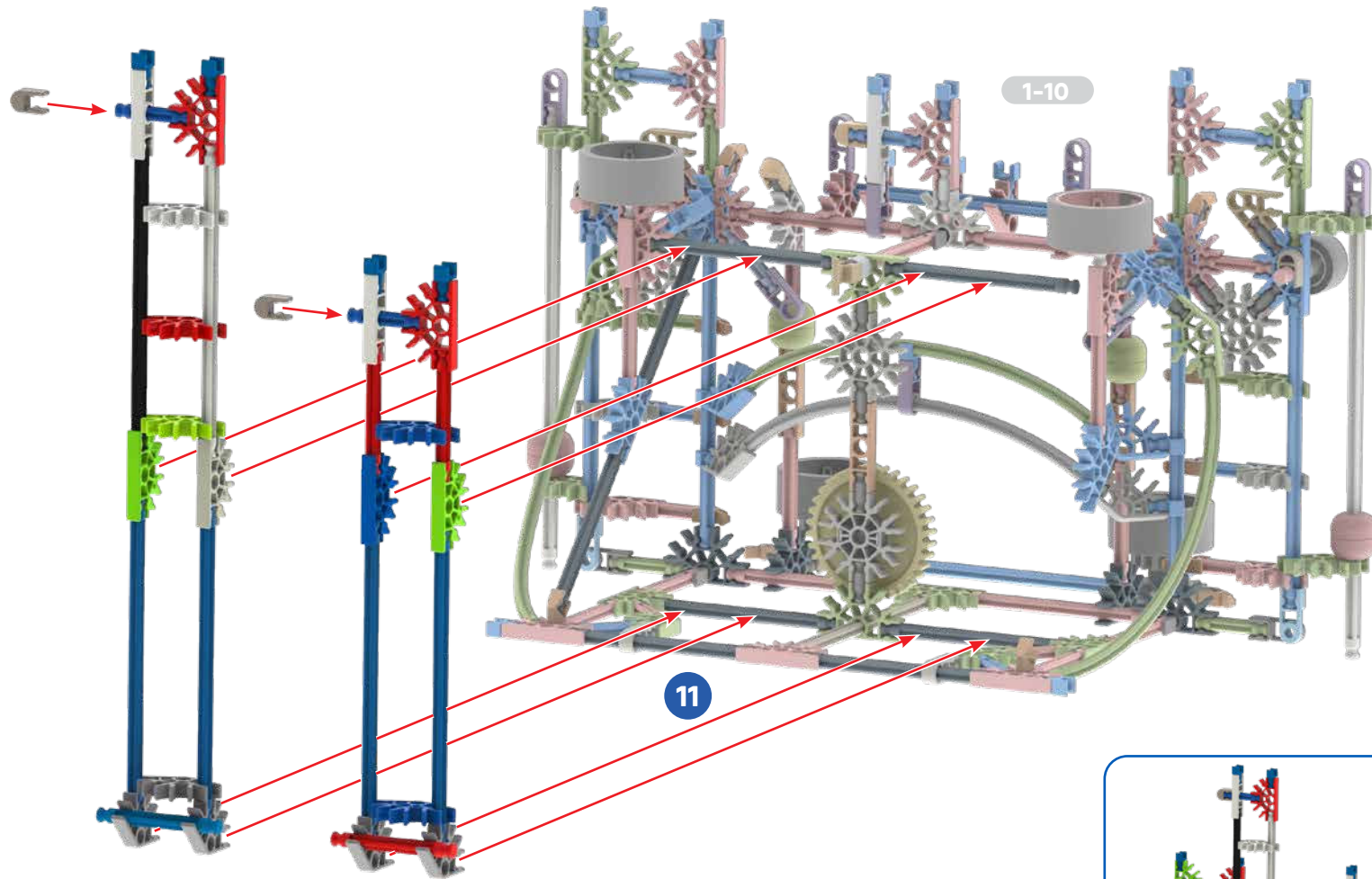

- | | | | | | | | | | | |
|---|--------|---|--------|---|--------|---|--------|--------|--------|--------|
| 2 | 909513 | 4 | 909142 | 2 | 914401 | 1 | 909054 | 5 | 909055 | |
| 1 | 91490 | | | | | | 2 | 909056 | 1 | 909057 |
| 3 | 909524 | 2 | 909023 | | | | 1 | 909059 | | |
| 4 | 92954 | | | | | | 1 | 909063 | 2 | 909064 |
| 1 | 909544 | | | | | | | | 2 | 909065 |
| 1 | 909542 | | | | | | | | | |



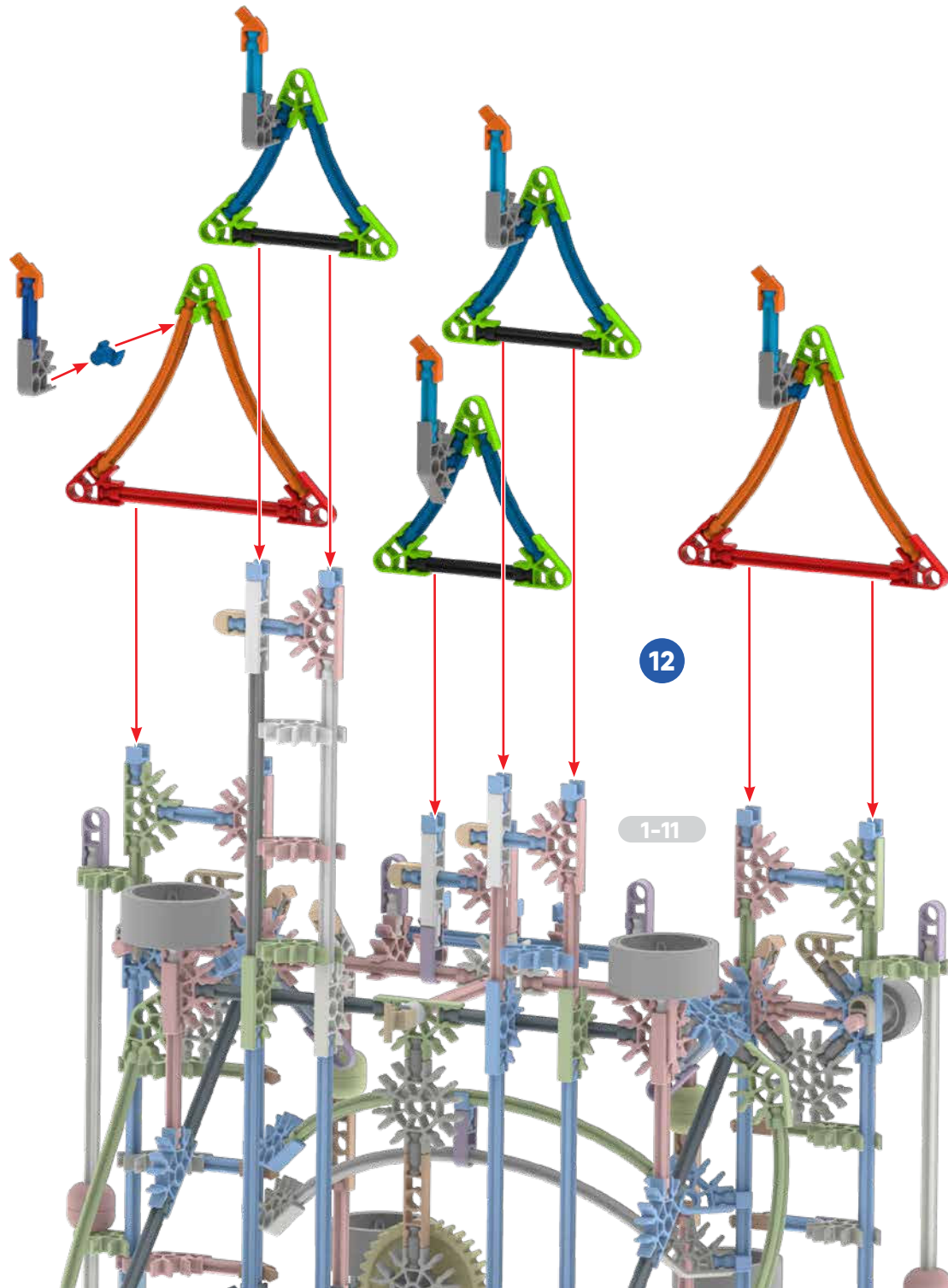

6		4		5		5	
	91490		914801		91690		909142
3		1		4		1	
	909523		909513		909042		909055
4			91282				
			91282				
2		4		11			
	909533		909032		909031		

12

1-11

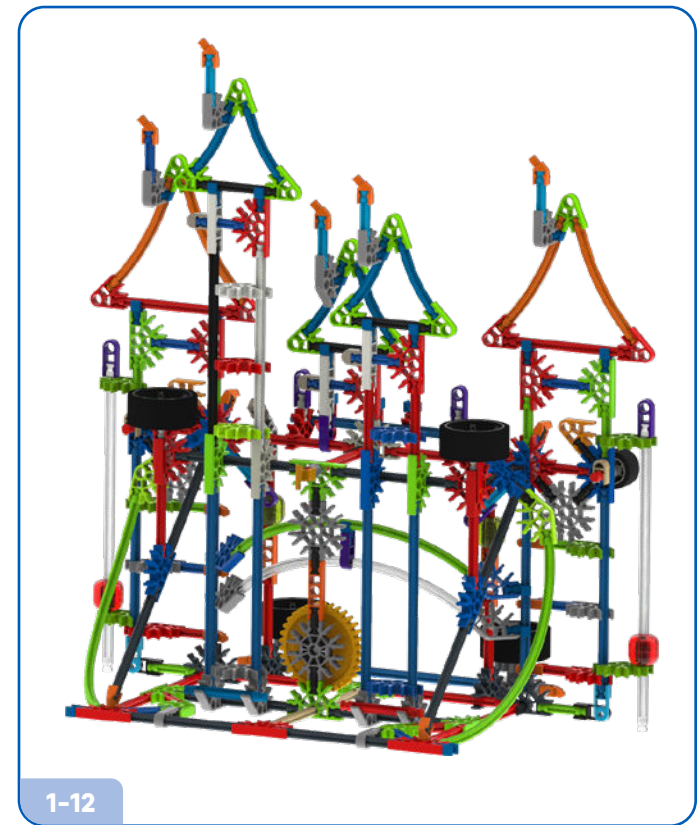

1-12

Tower Crane

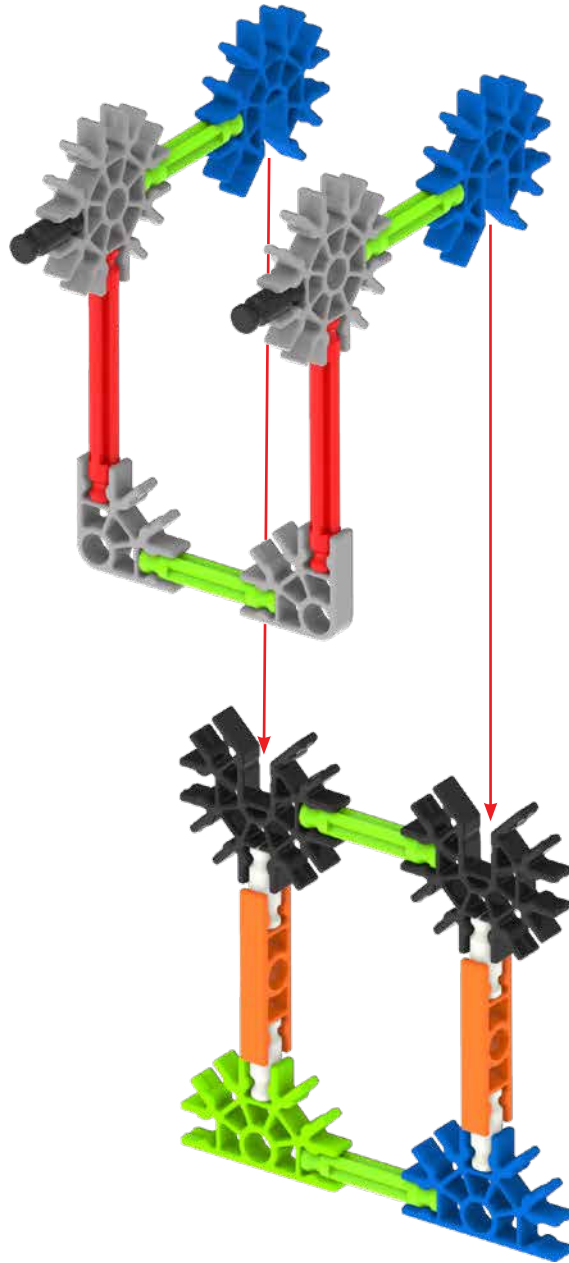

1

2 90960	2 909042	1 909063	1 909064
4 909503	2 90902	2 909074	2 909075
5 909512	2 909524	2 909081	

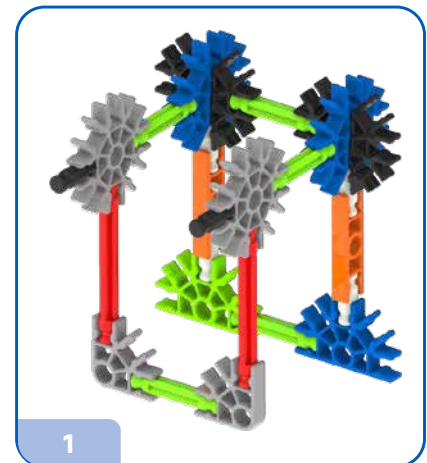

1

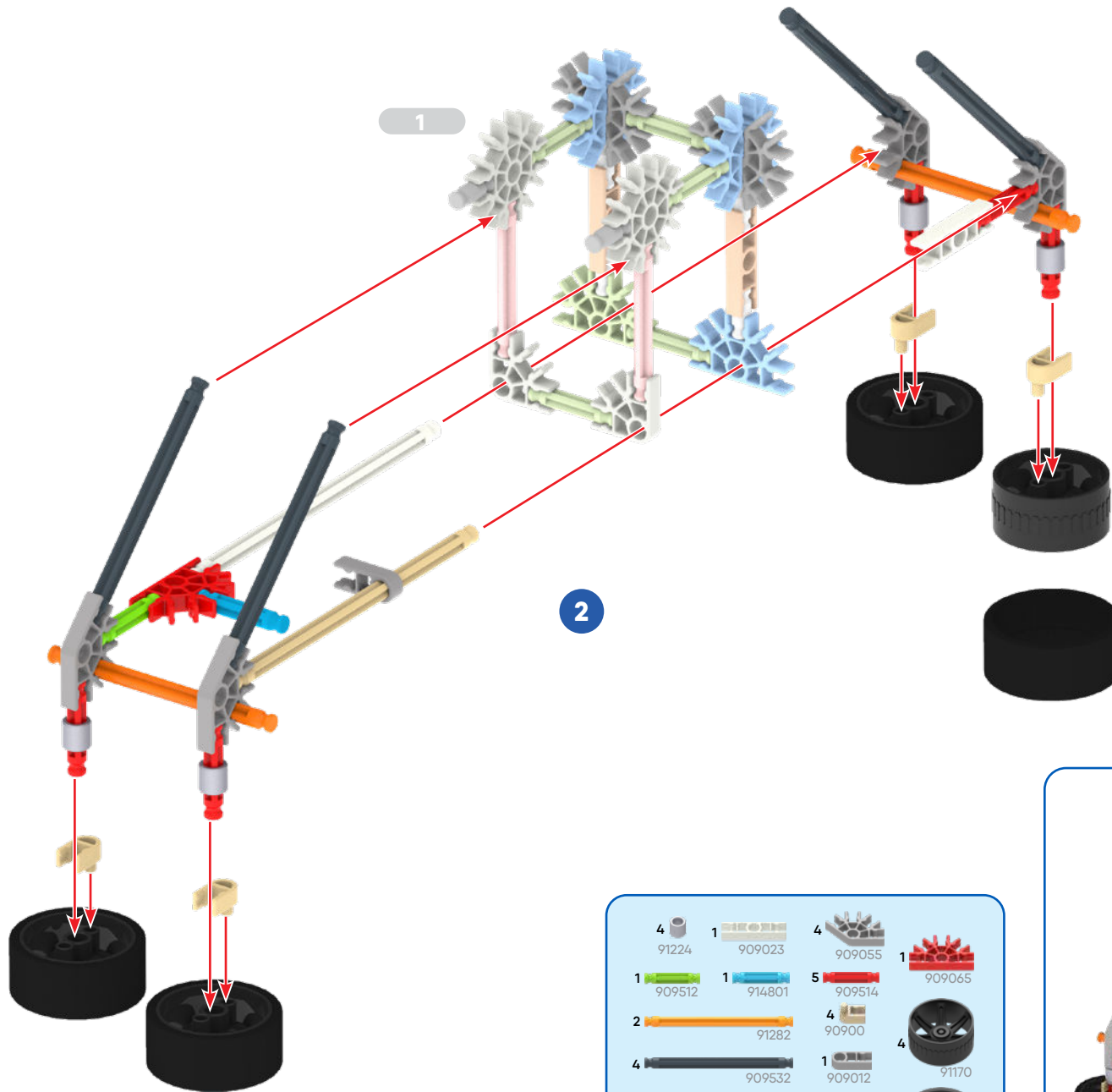

2

4 91224	1 909023	4 909055	1 909065
1 909512	1 914801	5 909514	1 909065
2 91282	4 90900	4 91170	
4 909532	1 909012	4 91380	
1 90957	1 909544		



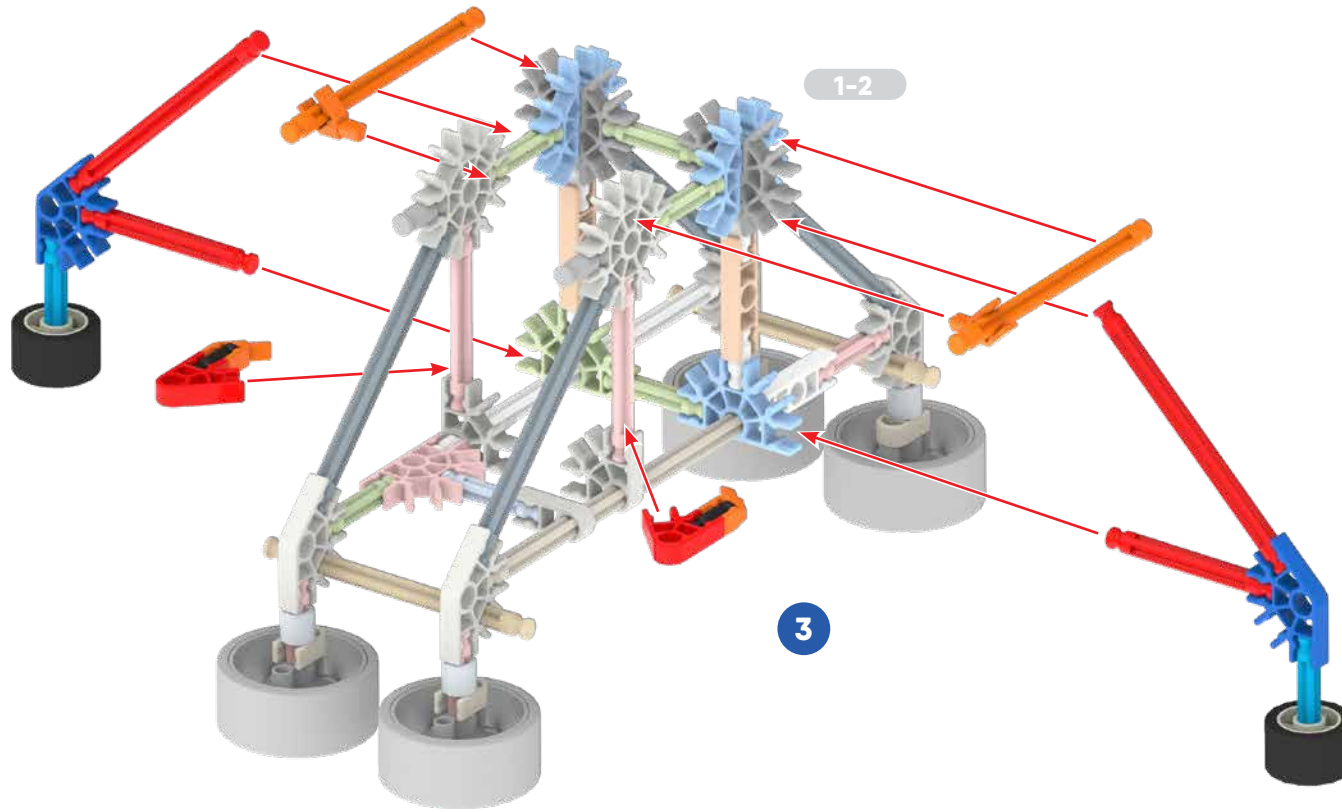

- | | | |
|--------|--------|--------|
| 2 | 4 | 2 |
| 90960 | 91690 | 909032 |
| 2 | 2 | |
| 914801 | 909056 | |
| 2 | | 2 |
| 909524 | | 531204 |
| 2 | | 2 |
| 91282 | | 845100 |
| 2 | | |
| 909533 | | |



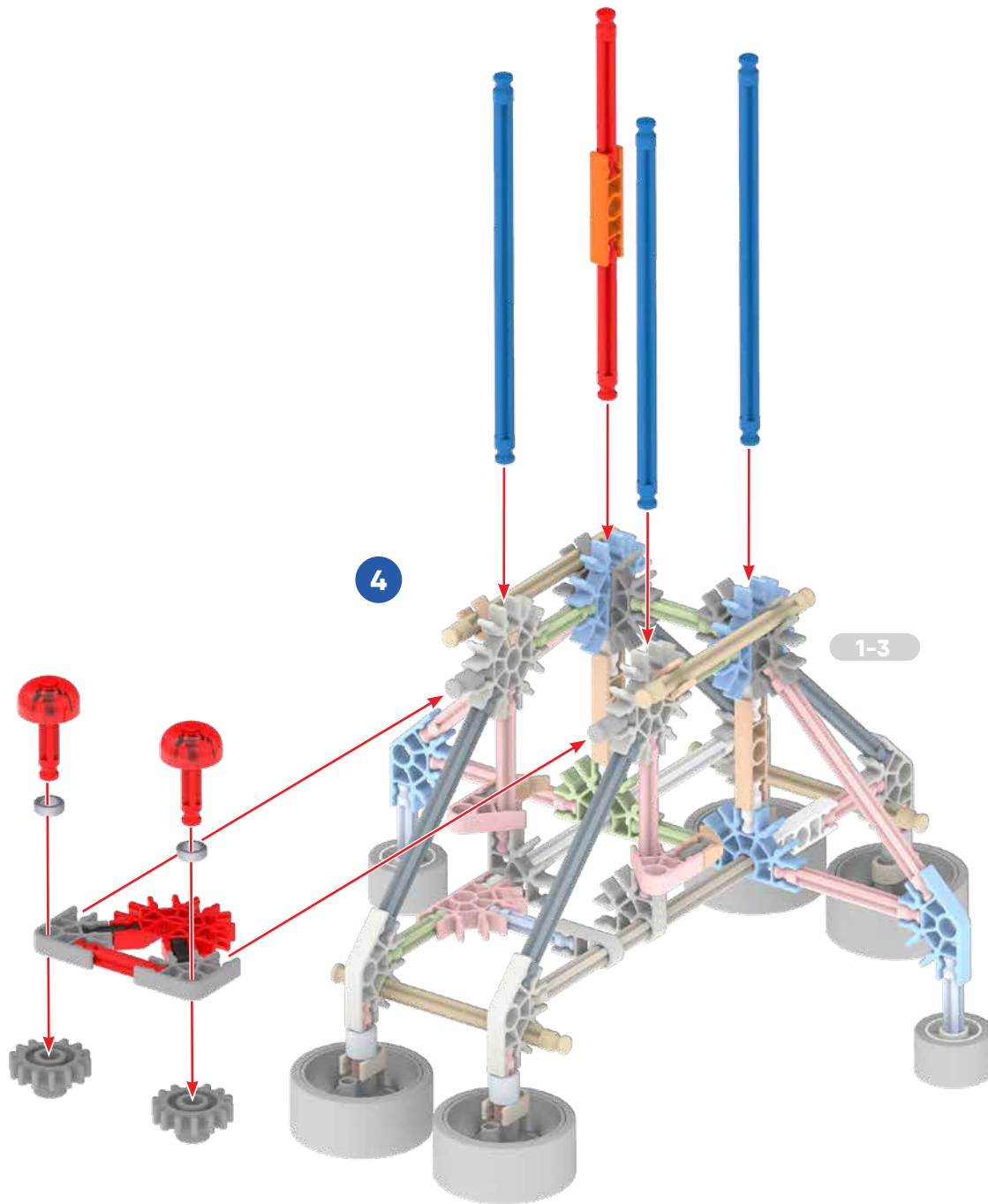

2	1	2
90960	90902	91920
3	2	2
909514	91994	90988
2	2	2
909524	909042	92954
3		



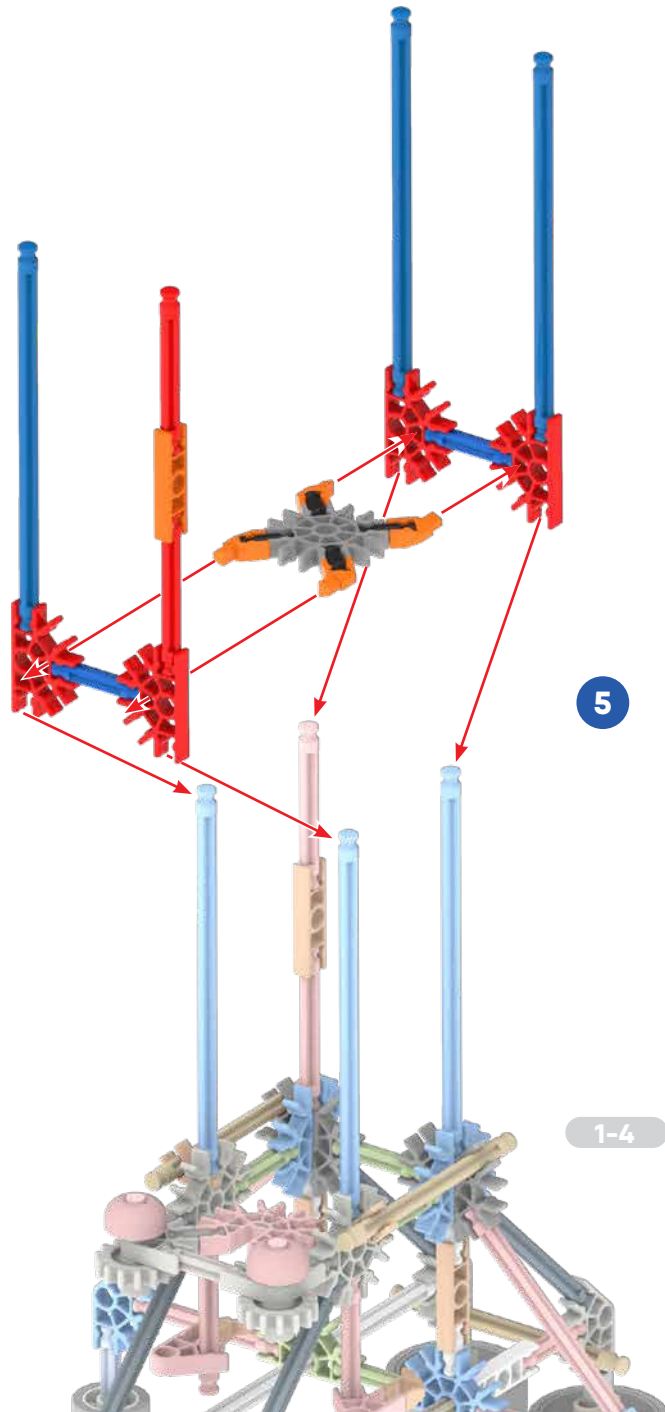

4	1	4
90960	90902	909065
2	4	1
909513	91690	909081
2		
909524		
3		
		92954



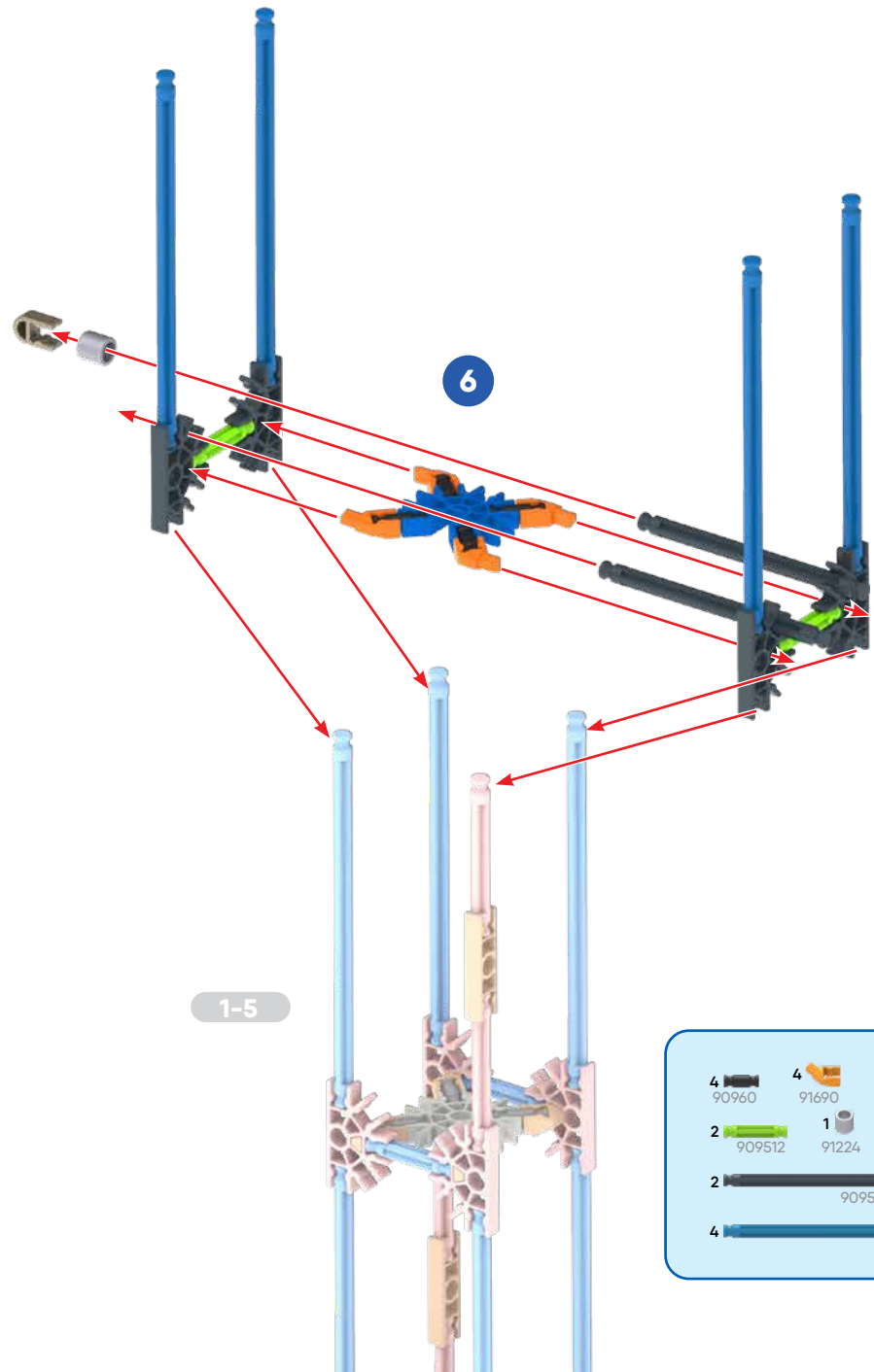

1-5

6

4	90960	4	91690	1	914401
2	909512	1	91224	4	909062
2	909532	4	909062	1	909074
4	92954				



1-6

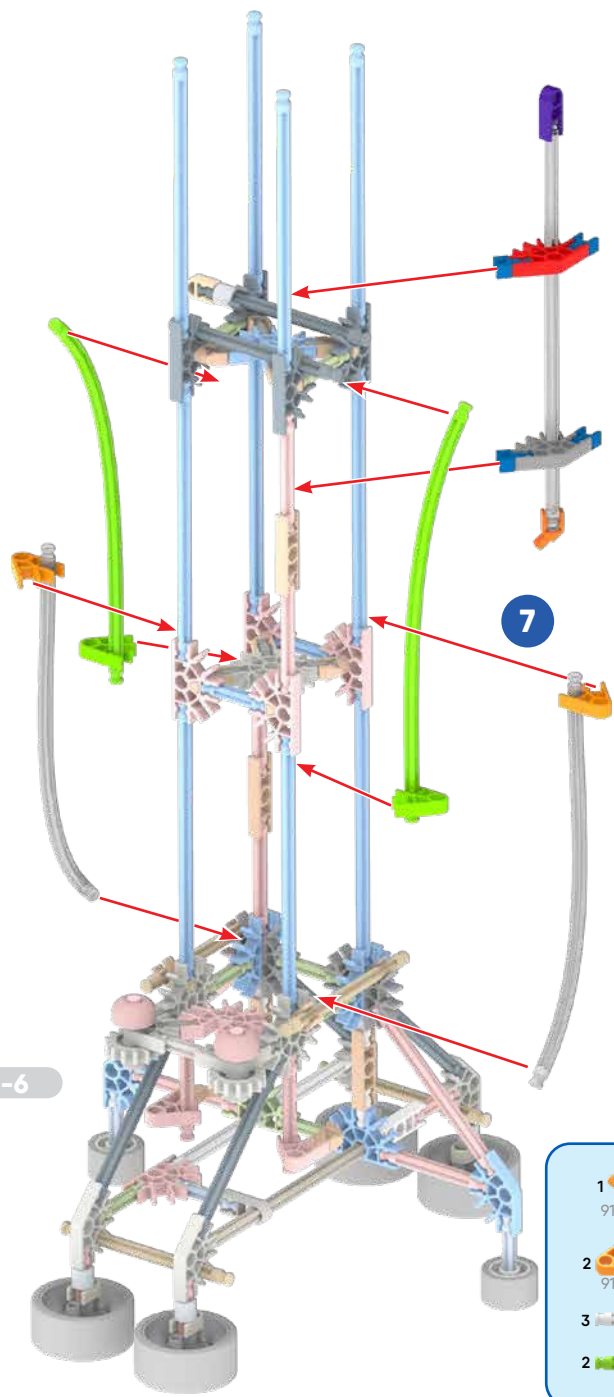

1-6

7

- | | | | |
|-------|--------|--------|--------|
| 1 | 4 | 1 | |
| 91690 | 909142 | 909011 | |
| 2 | 2 | 1 | 1 |
| 91903 | 909031 | 909055 | 909057 |
| 3 | | | |
| | | | 91100 |
| 2 | | | 91108 |



1-7

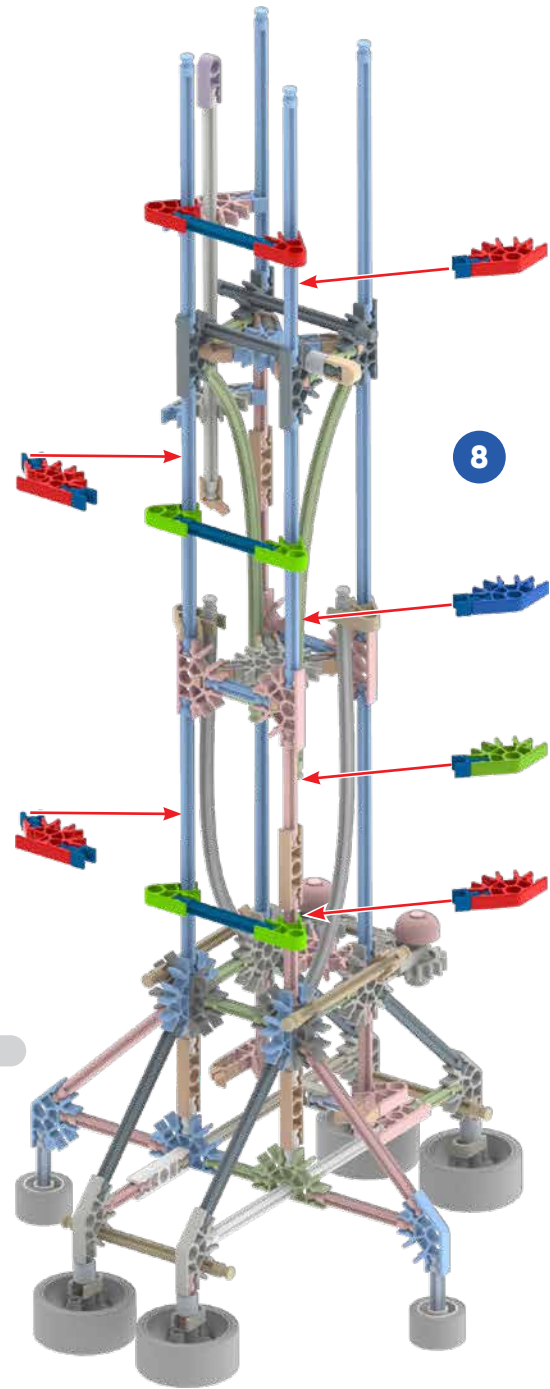

1-7

8

- | | | |
|-------------|-------------|-------------|
| 8
909142 | 4
909031 | 2
909032 |
| 1
909053 | 1
909056 | 2
909057 |
| 3
91490 | 2
909093 | |

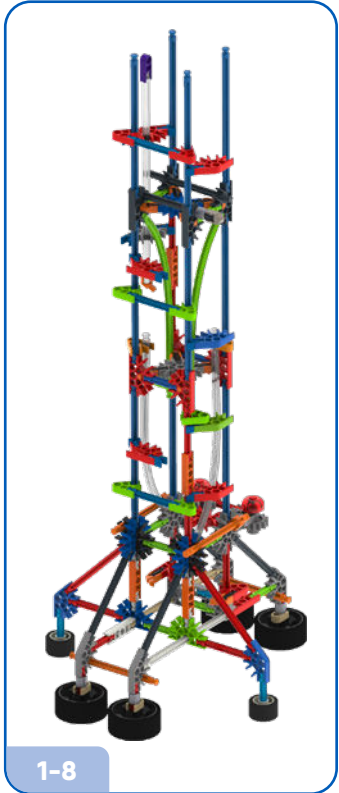

1-8

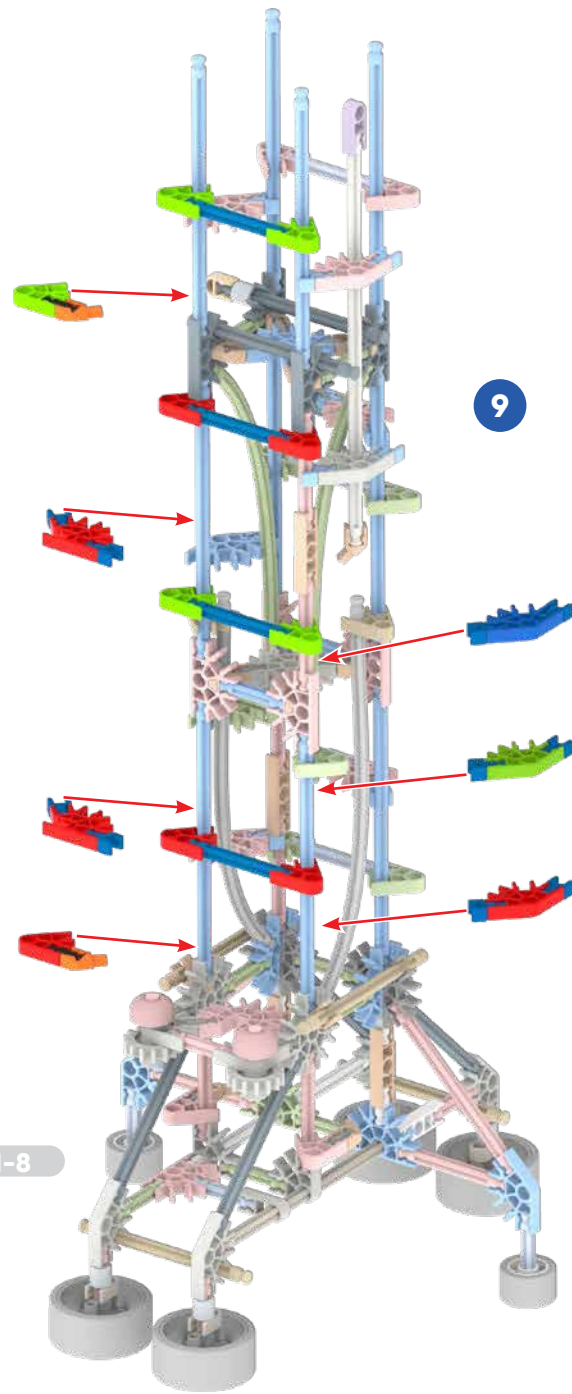

1-8

9

- | | | | |
|-------------|--------------|-------------|-------------|
| 2
91690 | 10
909142 | 5
909031 | 5
909032 |
| 1
909053 | 1
909056 | 1
909057 | |
| 2
90960 | 4
91490 | 2
909093 | |



1-9

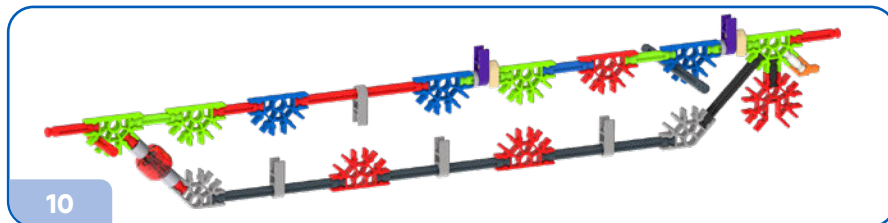
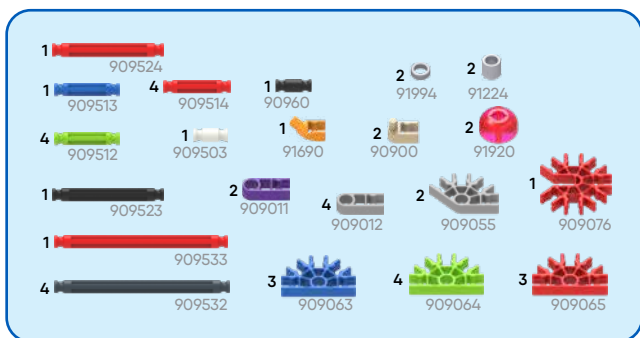
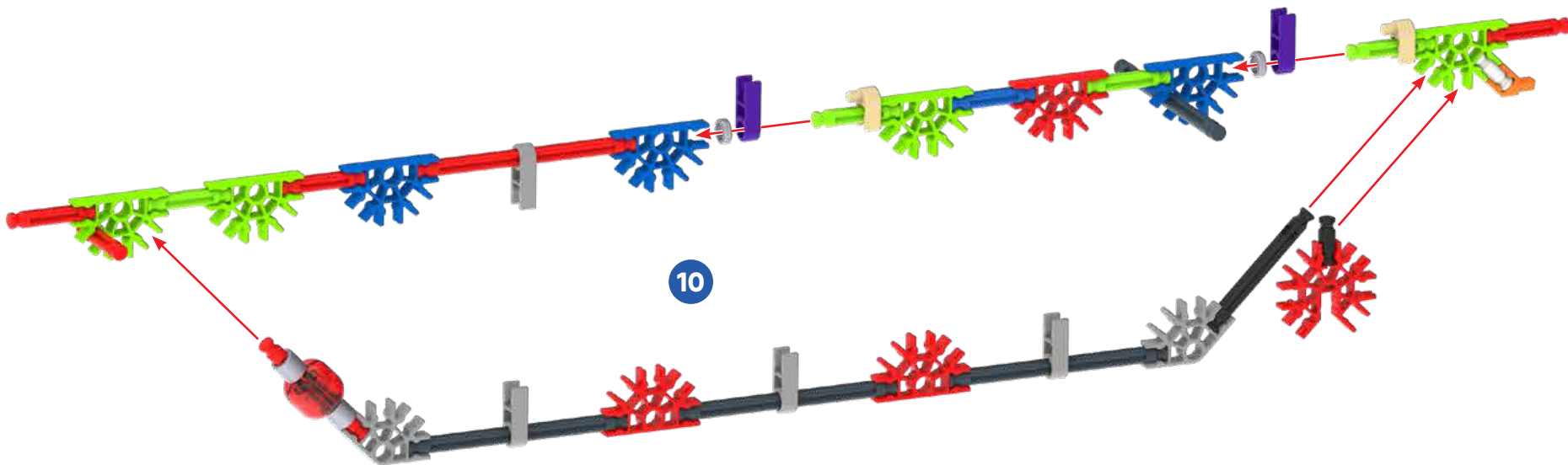

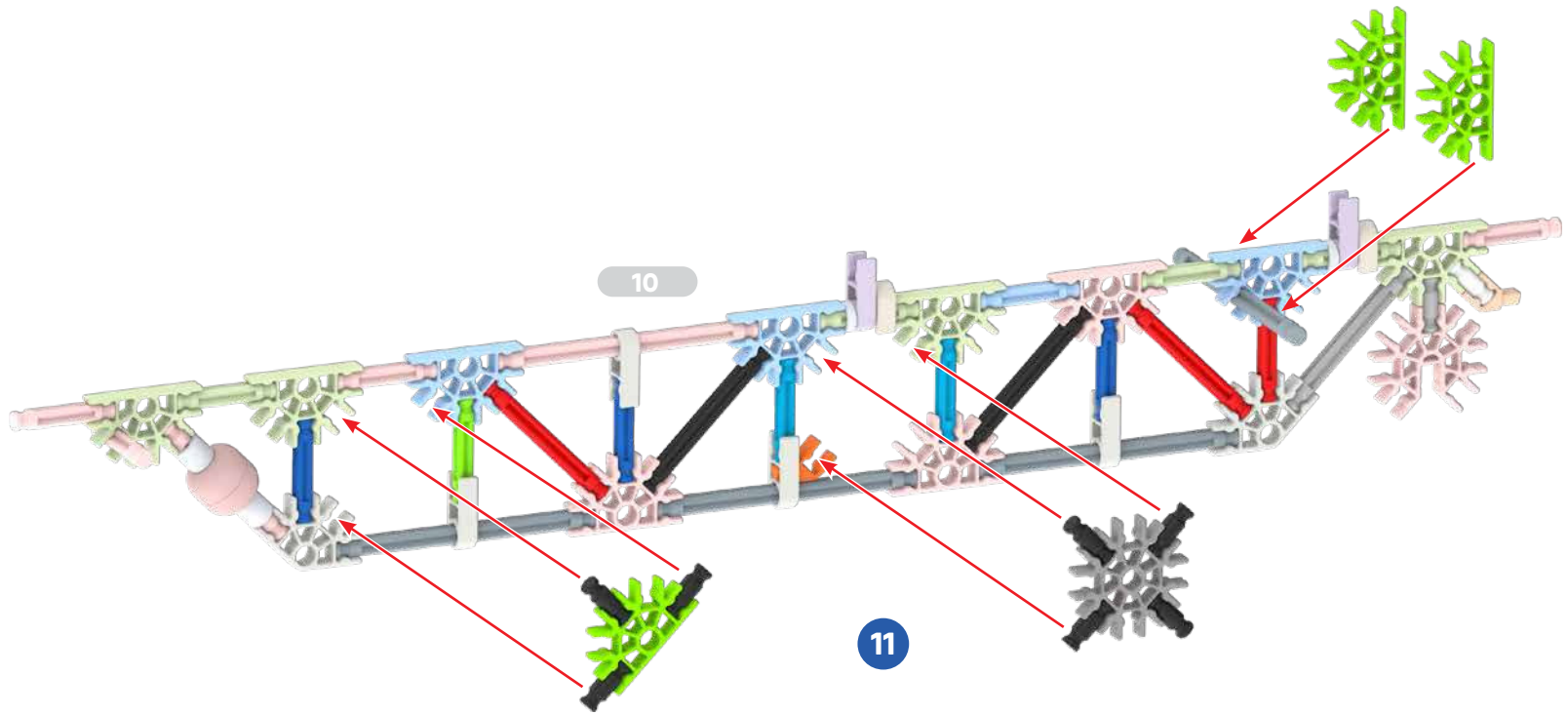

10

11

- | | | | |
|---|--------|---|--------|
| 1 | 909512 | 1 | 909514 |
| 3 | 909513 | 2 | 914801 |
| 2 | 909523 | 7 | 90960 |
| 2 | 909524 | 3 | 909064 |
| | | 1 | 909081 |

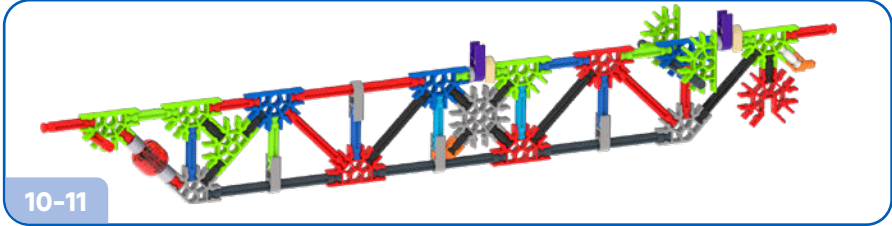

10-11

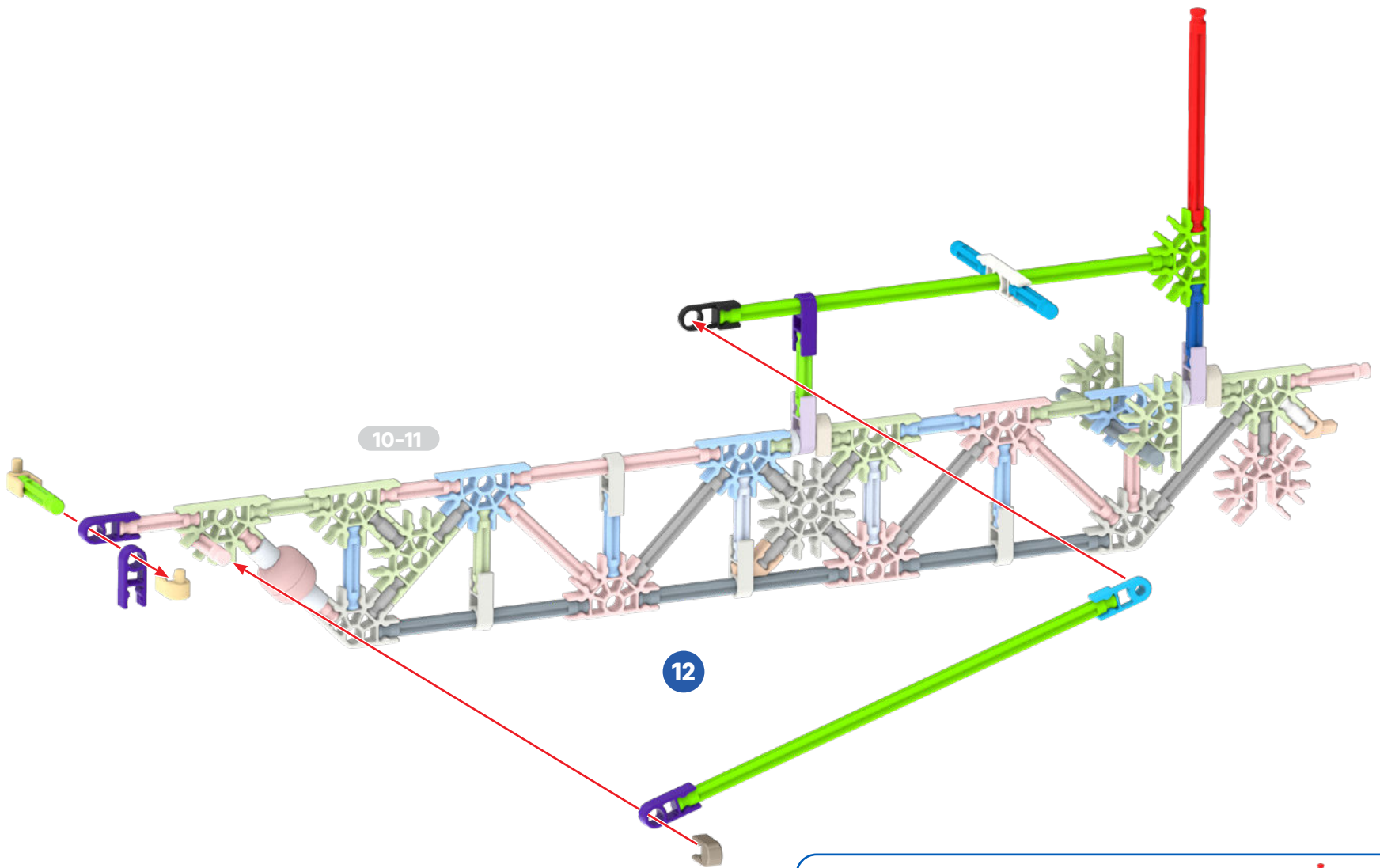

- | | | | | |
|--------|--------|--------|-------|--------|
| 1 | 2 | 4 | 1 | 1 |
| 914401 | 90900 | 909011 | 90919 | 90912 |
| 2 | 1 | 2 | | |
| 909512 | 909513 | 914801 | | 909064 |
| 1 | | 1 | | |
| | 909533 | 909023 | | |
| 2 | | | | |
| | | | | 91108 |

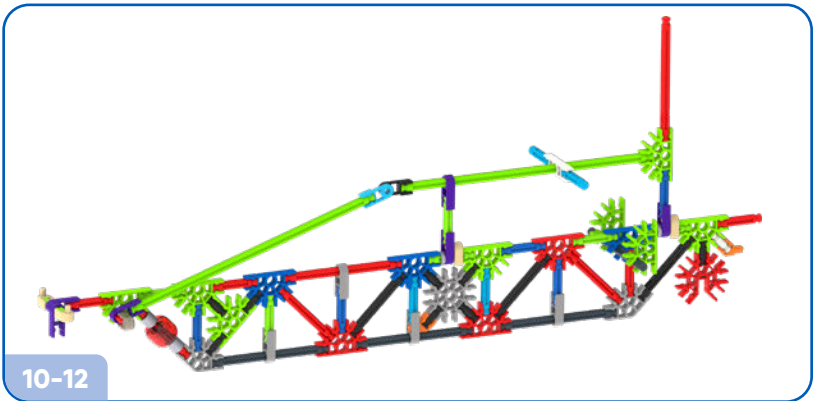

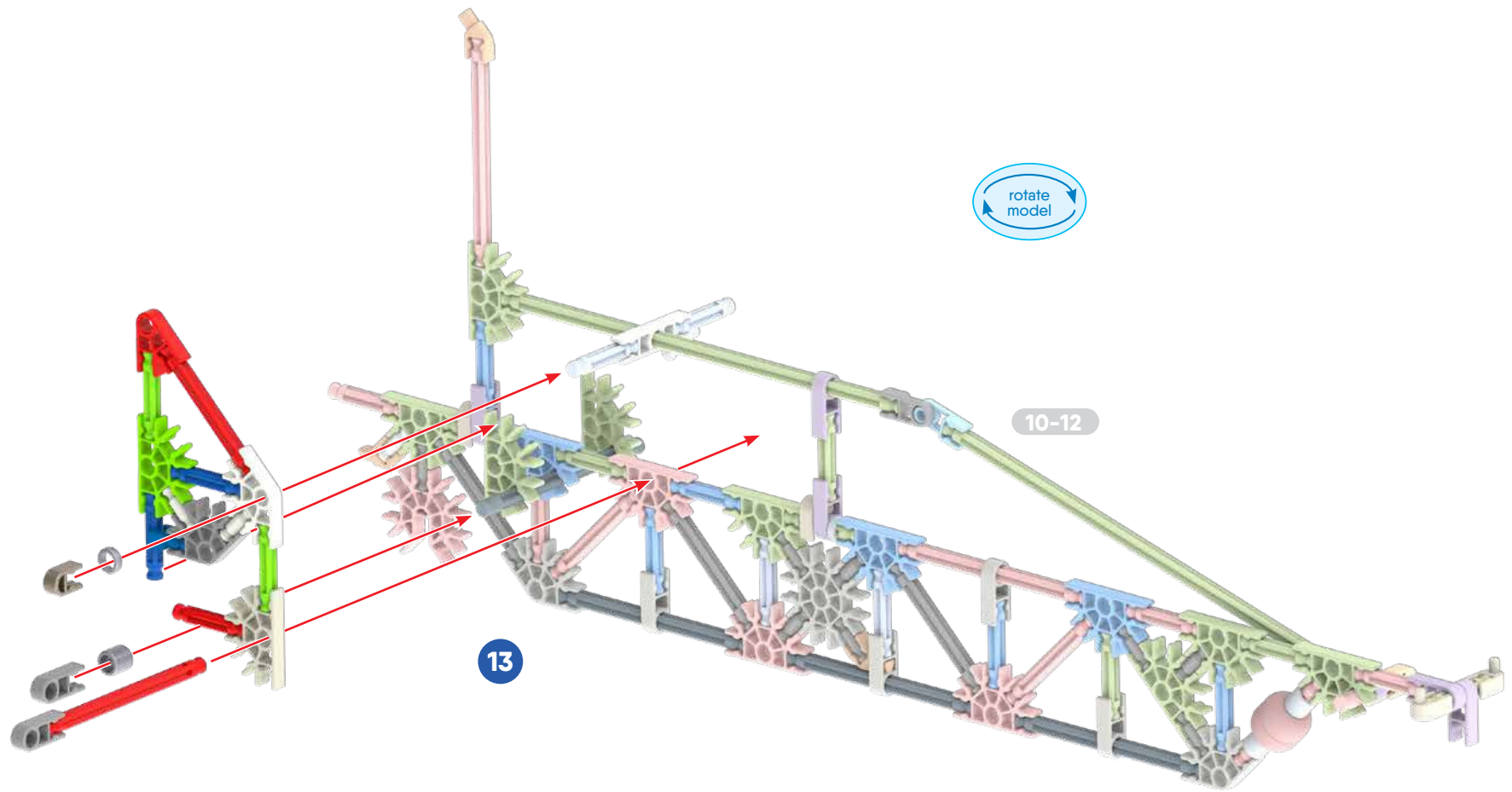

- | | | | |
|-------------|-------------|-------------|-------------|
| 1
909514 | 2
909503 | 1
91994 | 1
909142 |
| 2
909513 | 2
909012 | 1
91224 | 1
914401 |
| 2
909512 | 1
909055 | 1
909059 | |
| 1
909524 | 1
909032 | 1
90949 | 1
909064 |
| 1
909533 | | | |

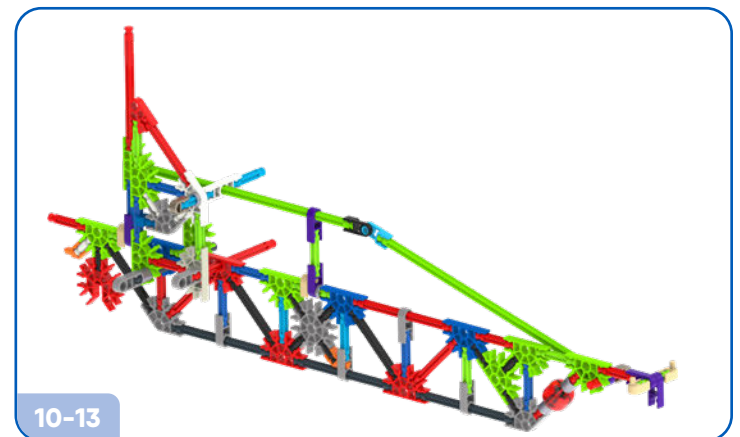

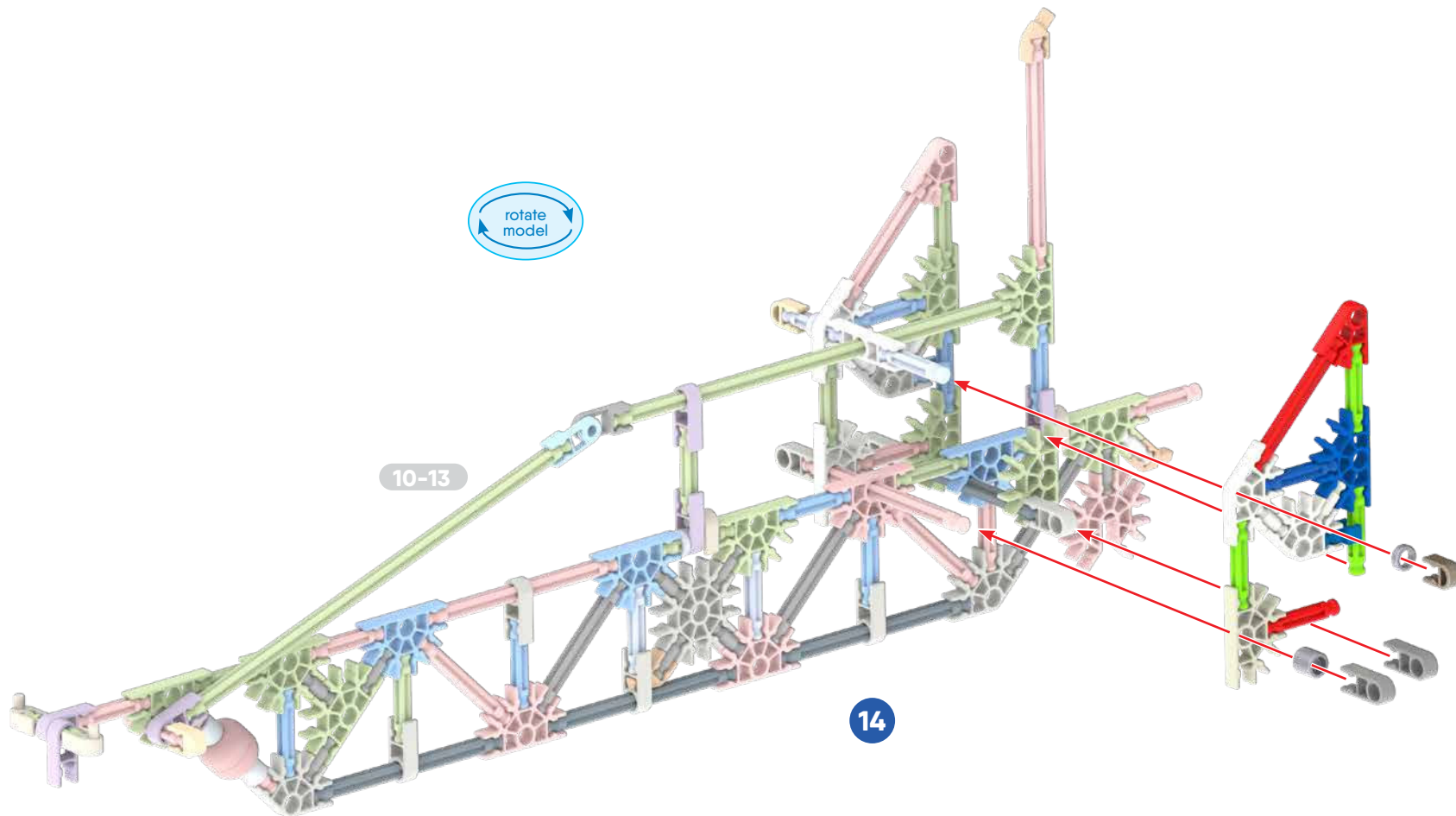

2 909503	1 909142	1 91994	1 91224
1 909514	2 909012	2 909059	1 914401
2 909513	1 909032	1 90949	1 909063
2 909512	1 909524		

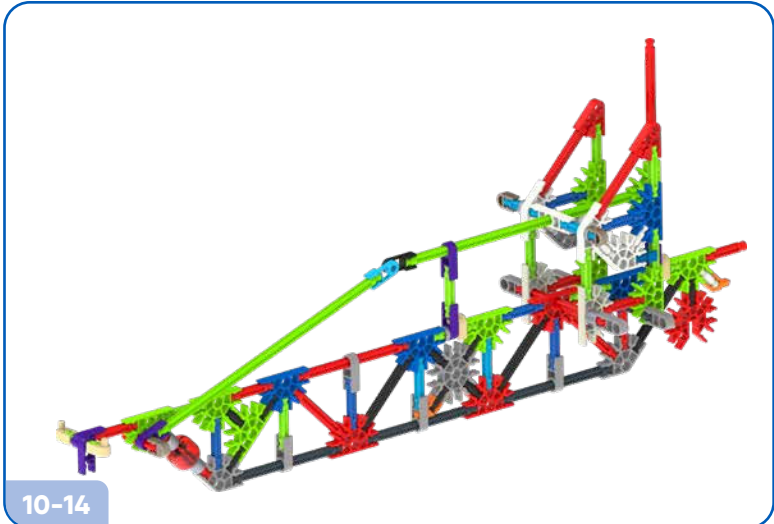

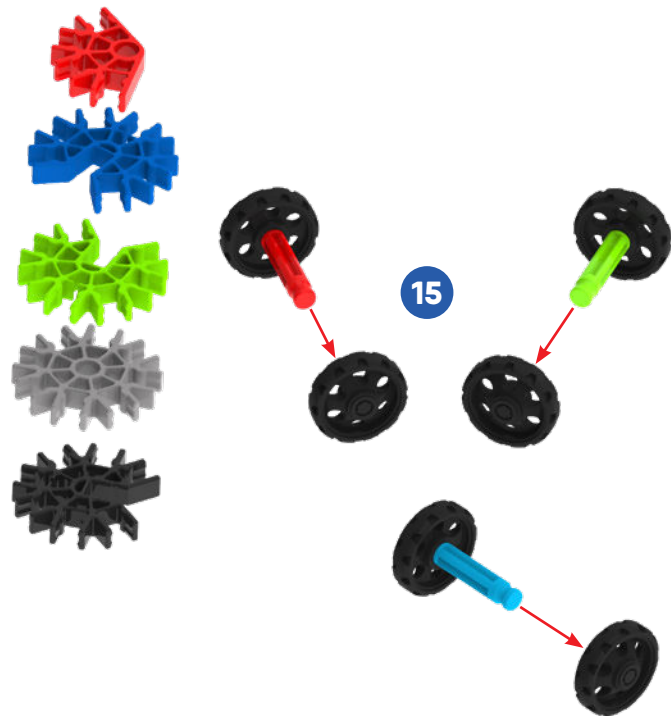

15

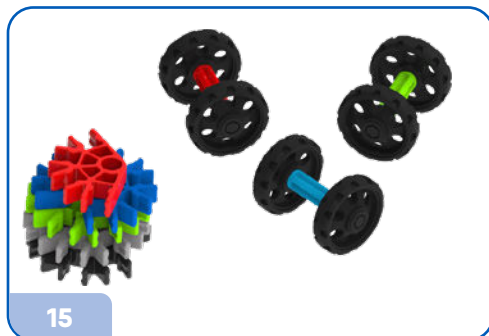

15

1		6	
1		1	
1		1	
1		1	
1		1	
1		1	
1		1	
1		1	
1		1	

16



2		1		2		4	
1		1		1		4	
1		1		1		4	
1		1		1		4	
1		1		1		4	



16

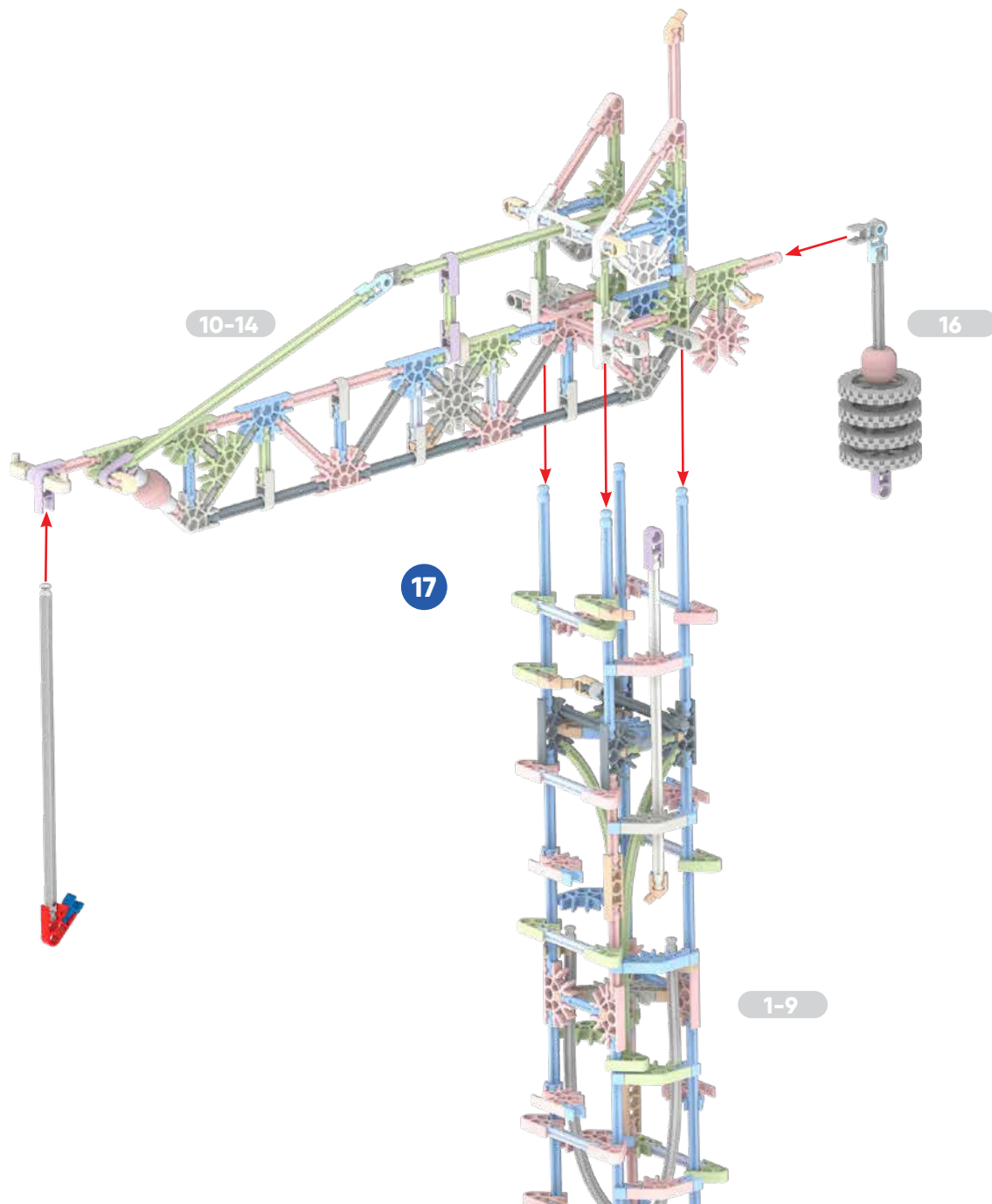

1		1	
	909142		909032
1			91100



Windmill

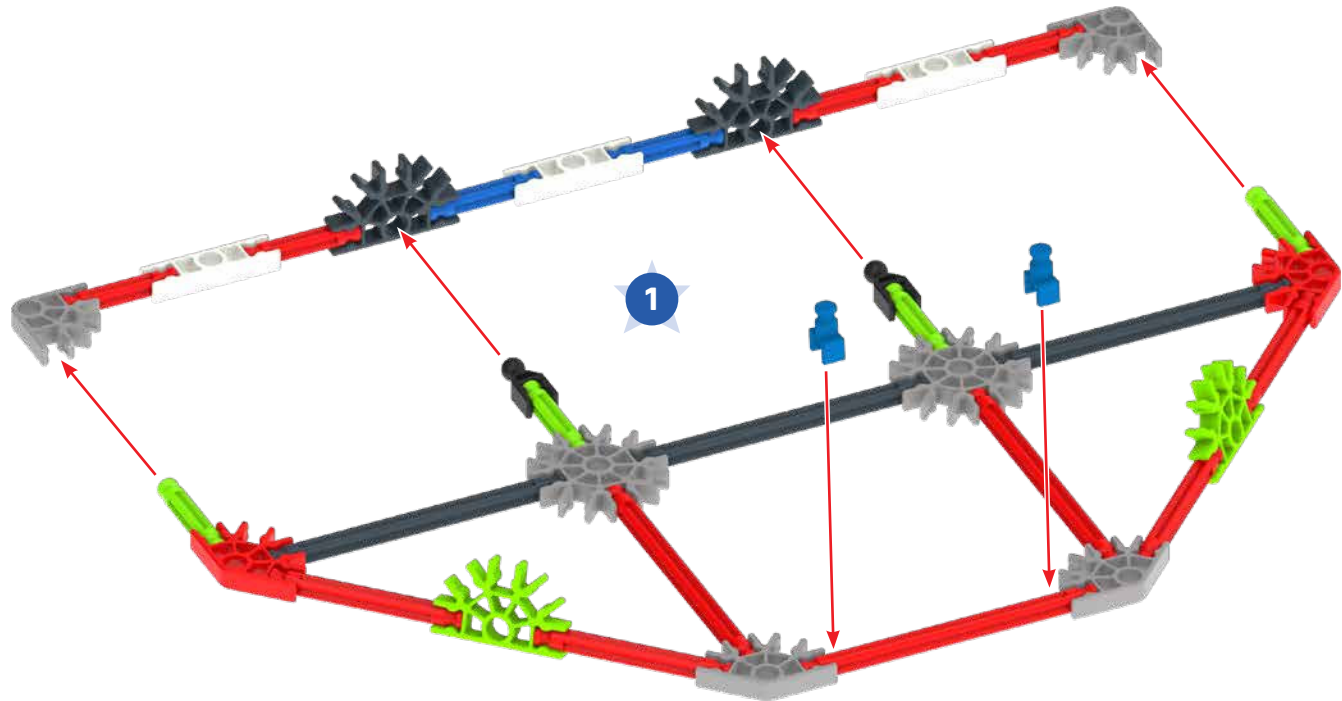

- | | | | | | | | | | |
|---|--------|---|--------|---|--------|---|--------|---|--------|
| 4 | | 2 | | 2 | | 2 | | 3 | |
| | 909512 | | 909513 | | 909142 | | 90940 | | 909023 |
| 4 | | | | 2 | | 2 | | 2 | |
| | 909514 | | | | 909042 | | 909055 | | 909057 |
| 4 | | | | | | | | | |
| | 909524 | | | | | | | | |
| 3 | | | | | | | | | |
| | 909532 | | | | | | | | |
| 3 | | | | 2 | | 2 | | 2 | |
| | 909533 | | | | 909062 | | 909064 | | 909081 |

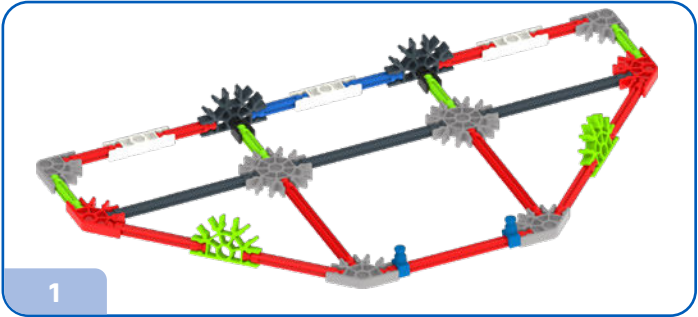

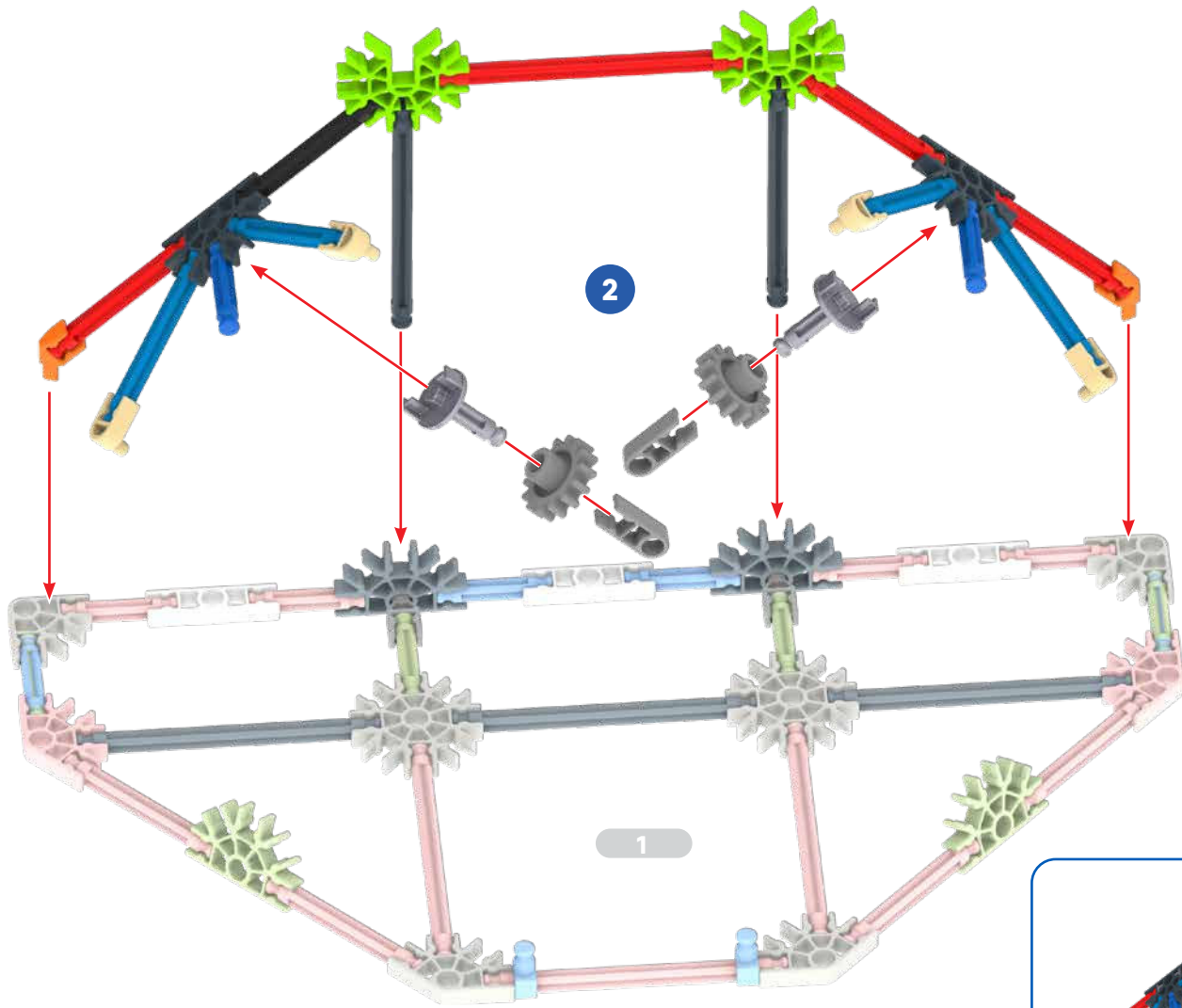

4		2	
	91490		909513
3		4	
	909524		90900
1		2	
	909523		909012
1		2	
	909533		91620
2		2	
	909532		909062
		2	
			90988
		2	
			909073

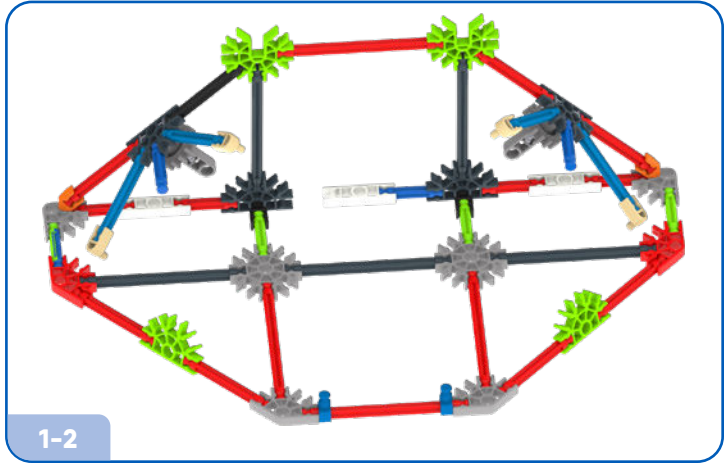

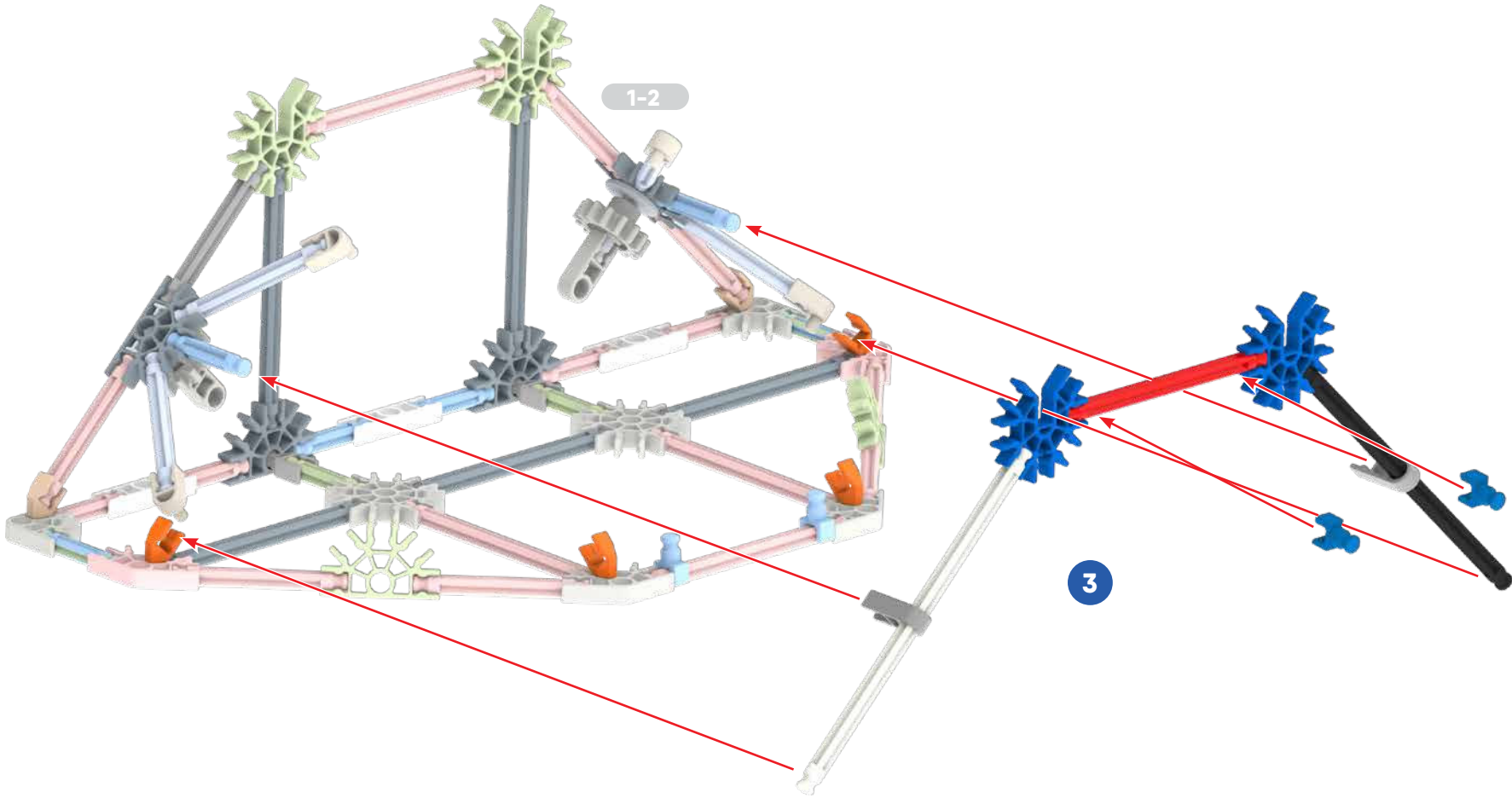

- | | | | | | | | |
|---|-------|---|--------|---|--------|---|--------|
| 4 | | 2 | | 2 | | 2 | |
| | 91690 | | 909142 | | 909012 | | 909074 |
| 1 | | | | | | | |
| | | | | | 909533 | | |
| 1 | | | | | | | |
| | | | | | 909544 | | |
| 1 | | | | | | | |
| | | | | | 909542 | | |

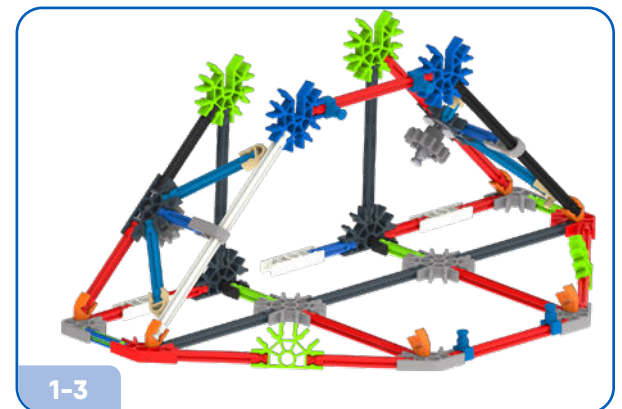

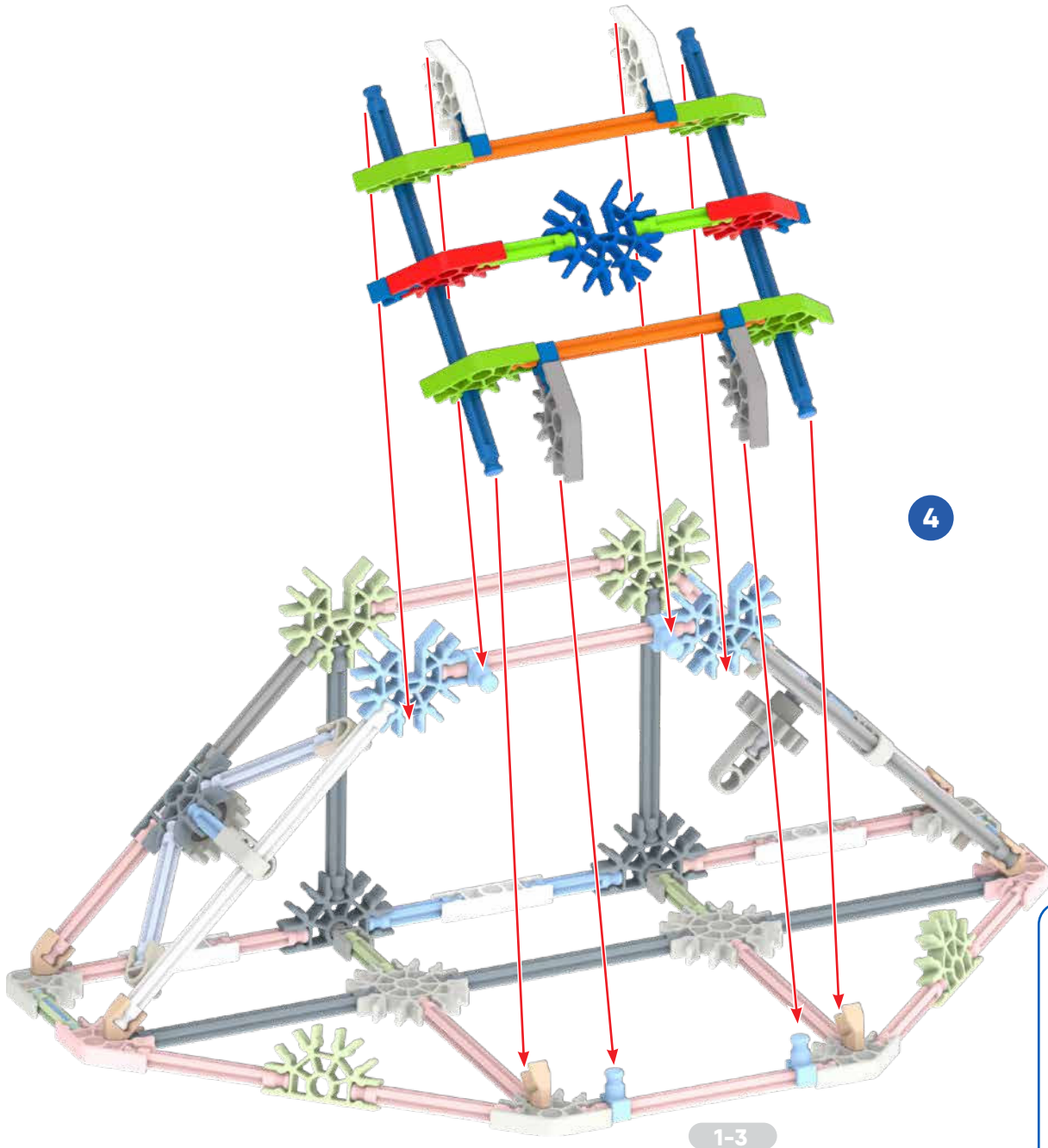

4

2		6		2		2		2	
	909512		909142		909053		909054		909055
2									
	91282								
2		2		2		1			
	92954		909057		909059		909074		

1-3

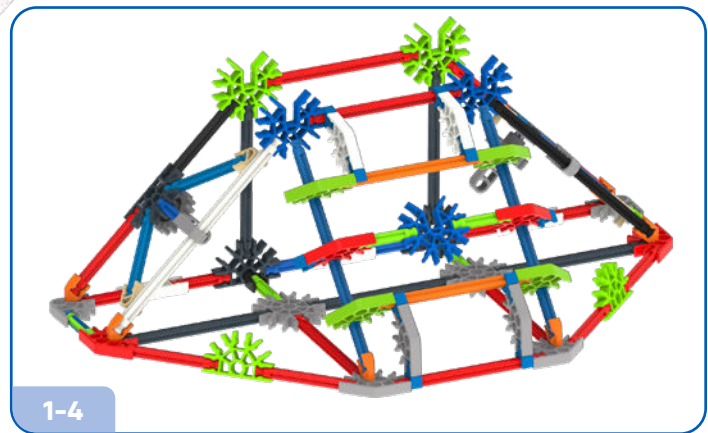

1-4

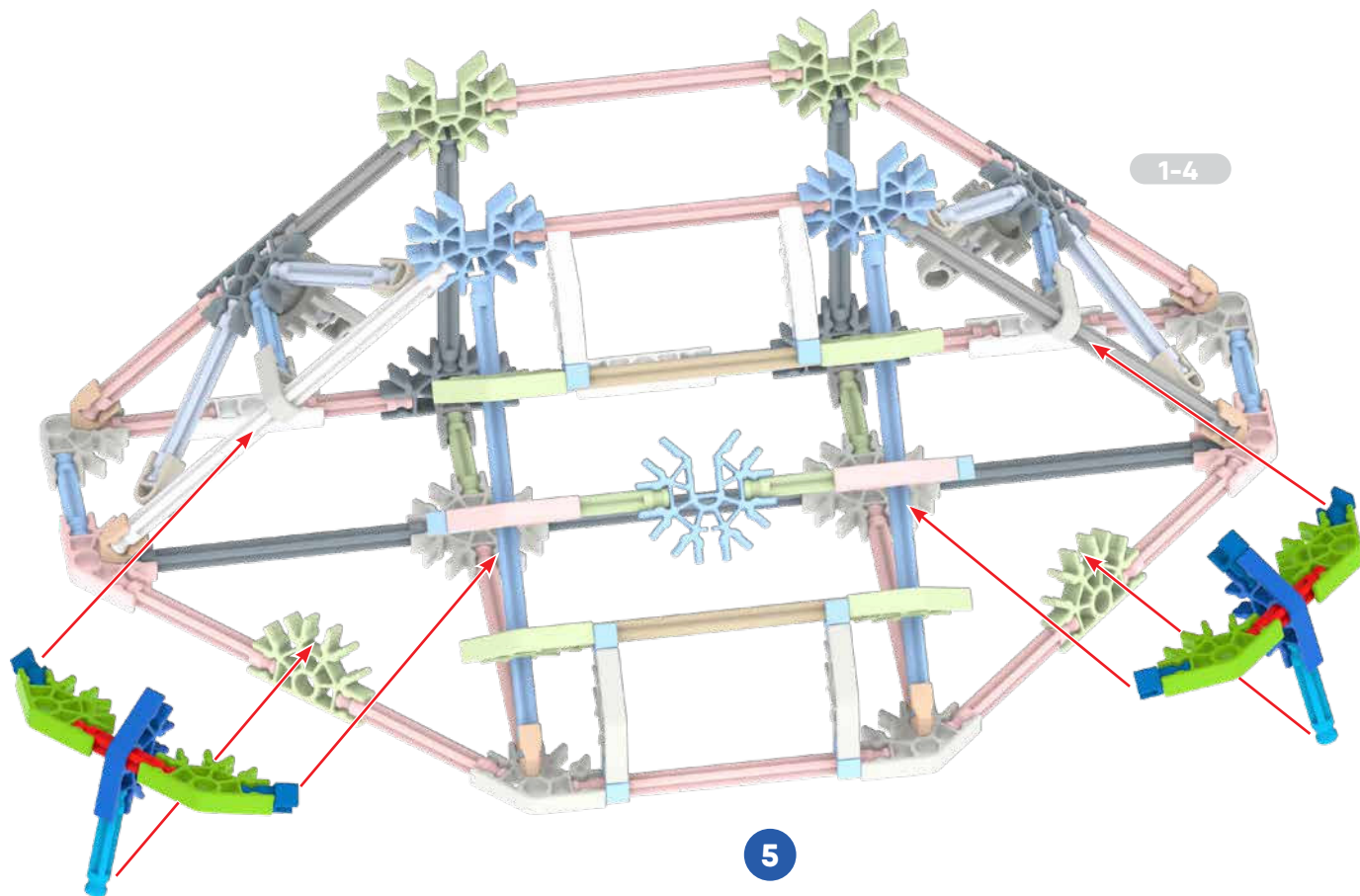

- 6  909142
- 2  914801
- 2  909514
- 4  909053
- 2  909056

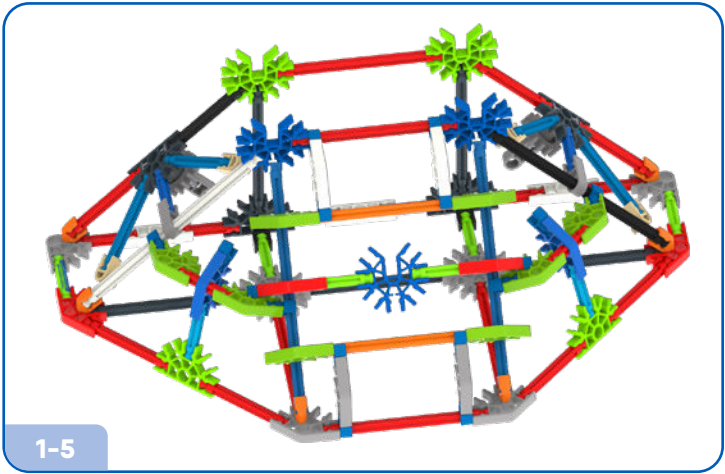

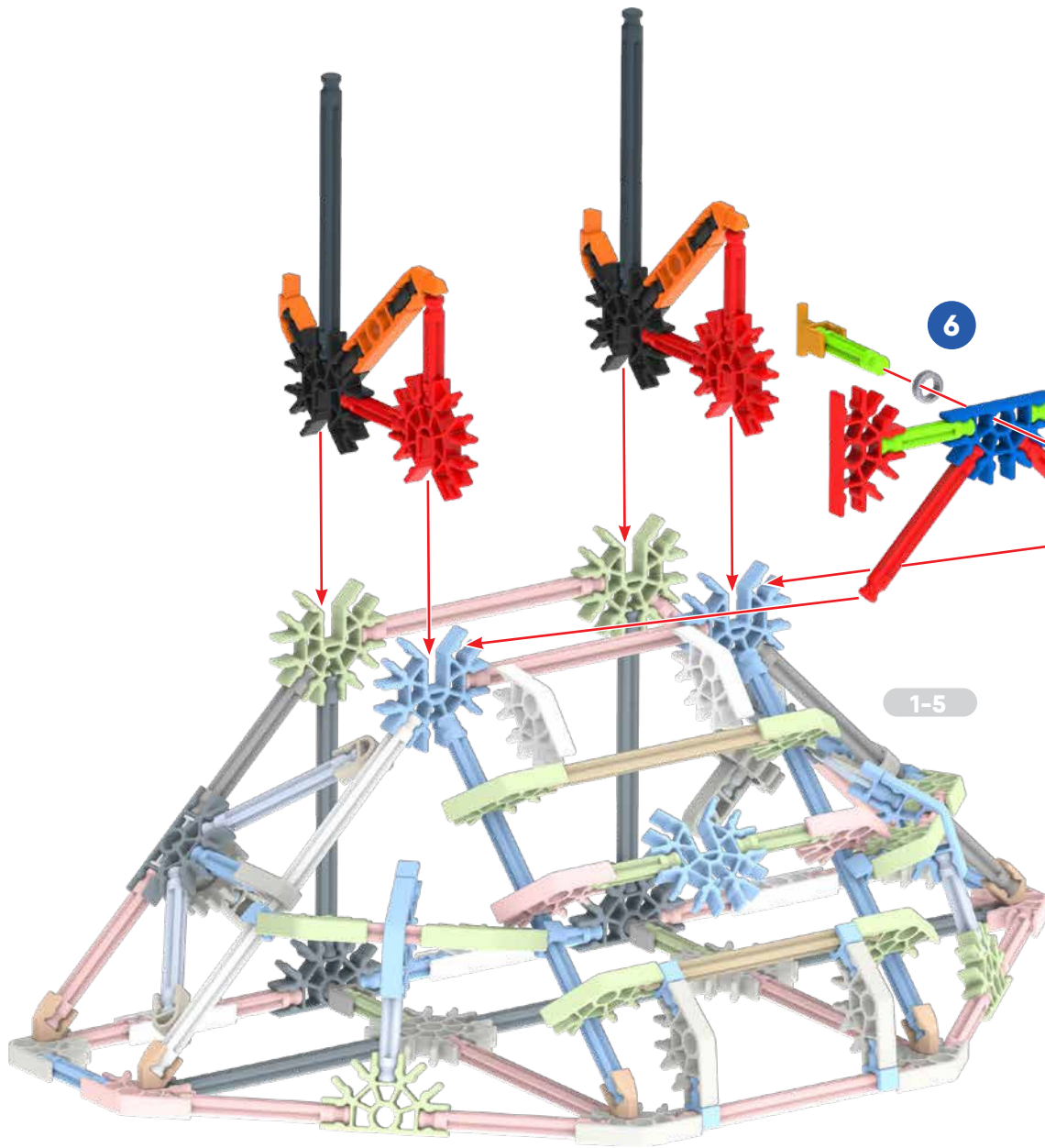

1-5

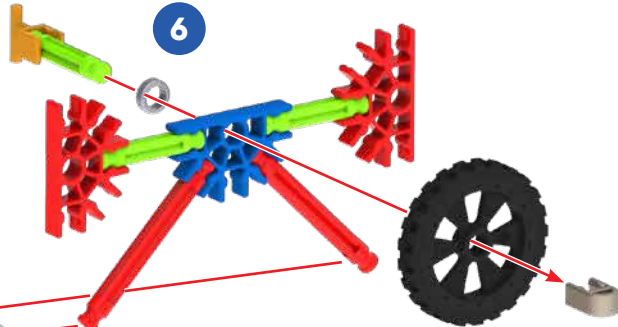

6

6	1	1	4			
90960	90911	914401	91690			
			2	2	2	2
3	1		90902	909075	909076	
909512	91994					
4	1	2	909063	909065		
909514						
2		2	909532	909524	1	1
					919780	91975

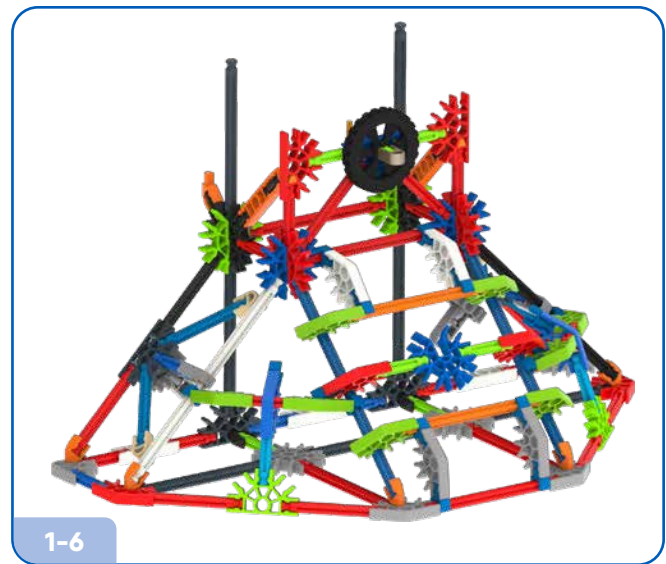

1-6

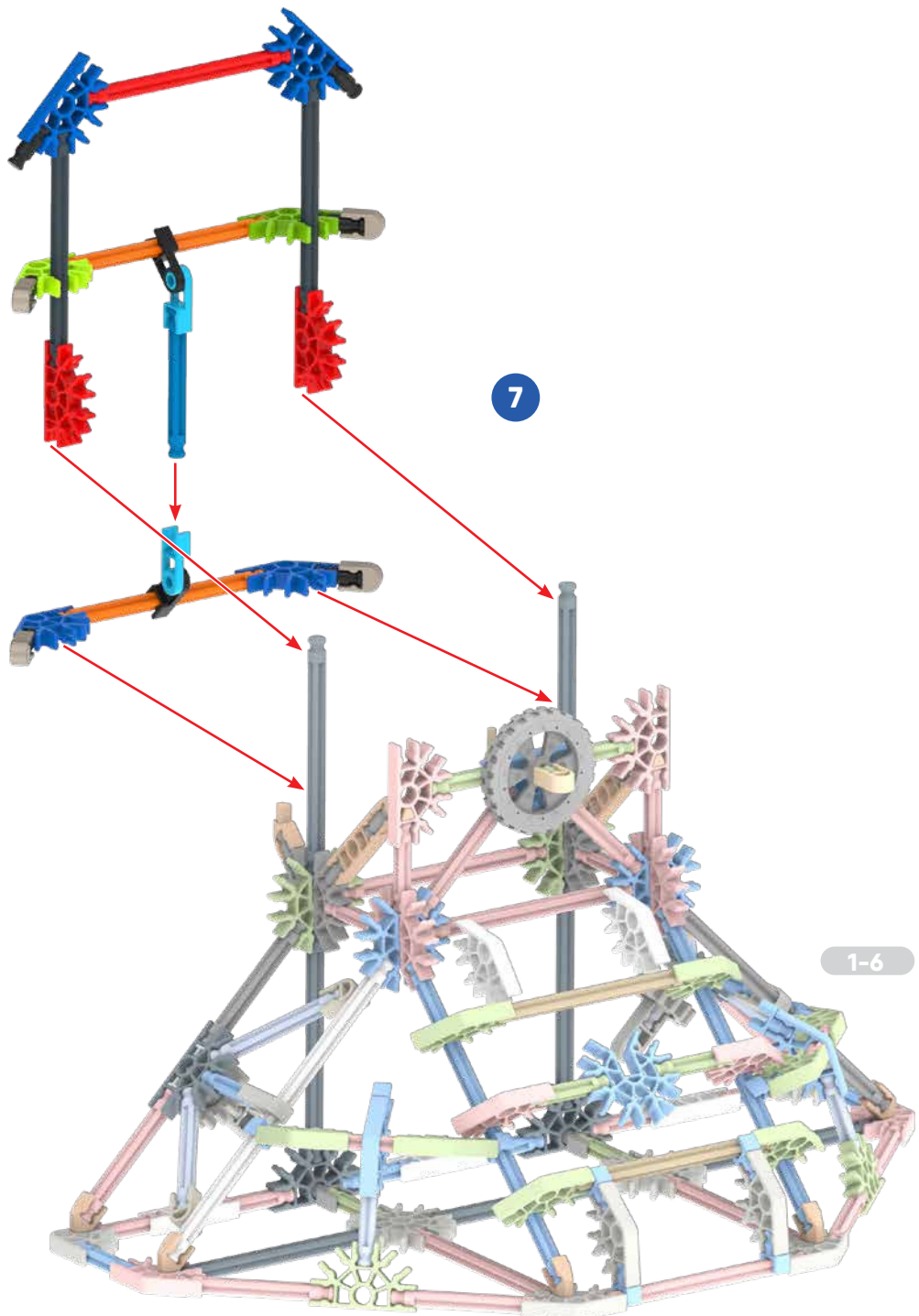

7

- | | | |
|-------|--------|--------|
| 6 | 4 | 2 |
| 90960 | 914401 | 90912 |
| 1 | 91490 | 2 |
| | | 90919 |
| 2 | 91282 | 2 |
| | | 909054 |
| 1 | 909533 | 2 |
| | | 909063 |
| 2 | 909532 | 2 |
| | | 909065 |

1-6

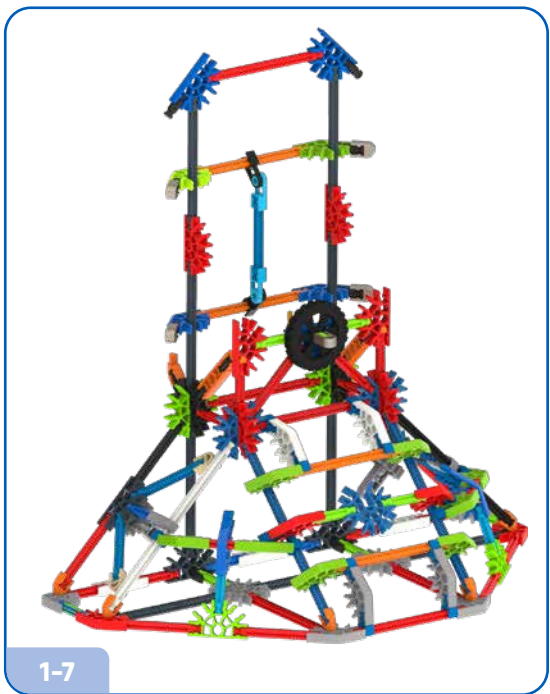

1-7

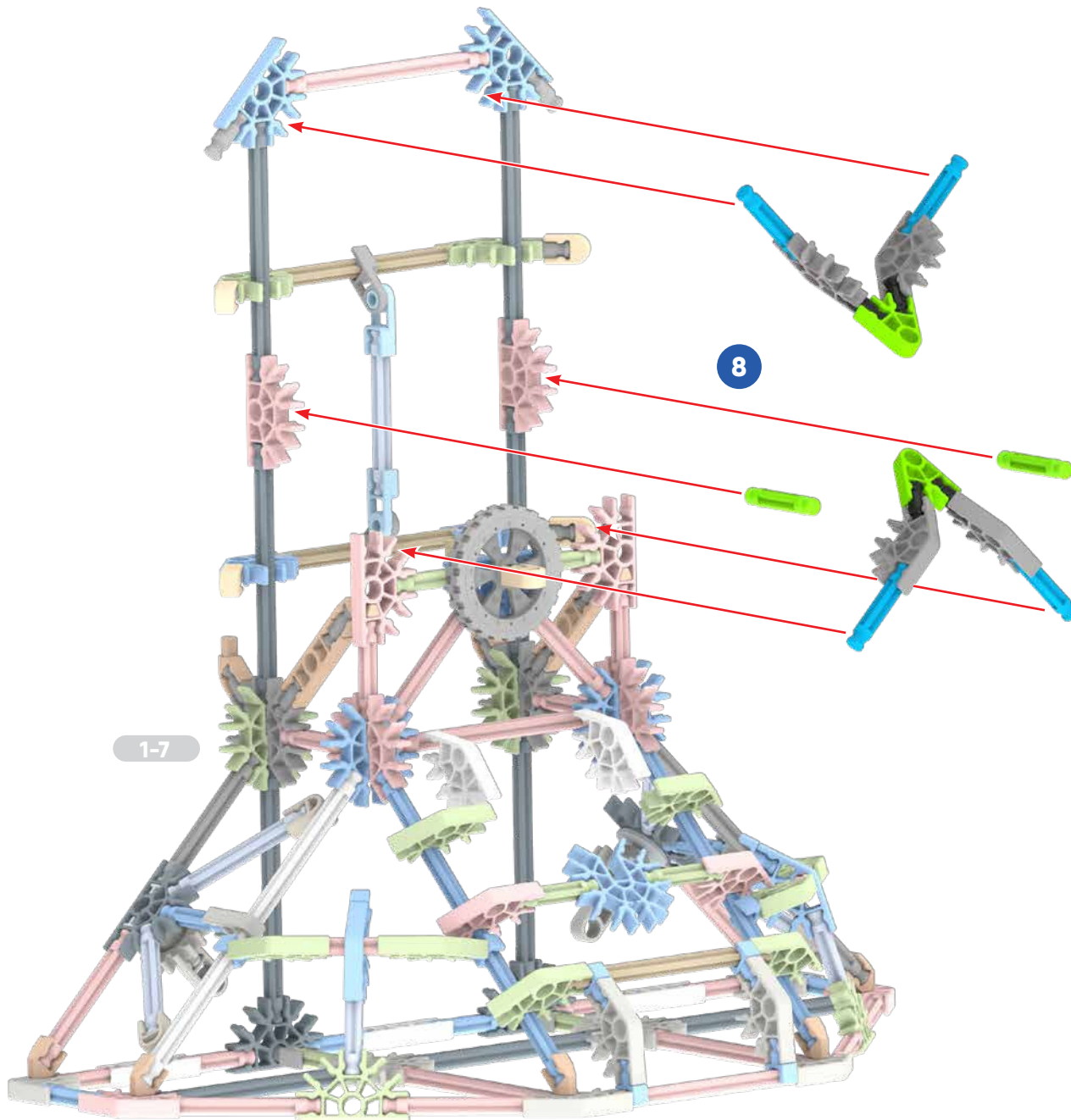

4	90960	2	909031
4	914801	4	909055
2	909512		

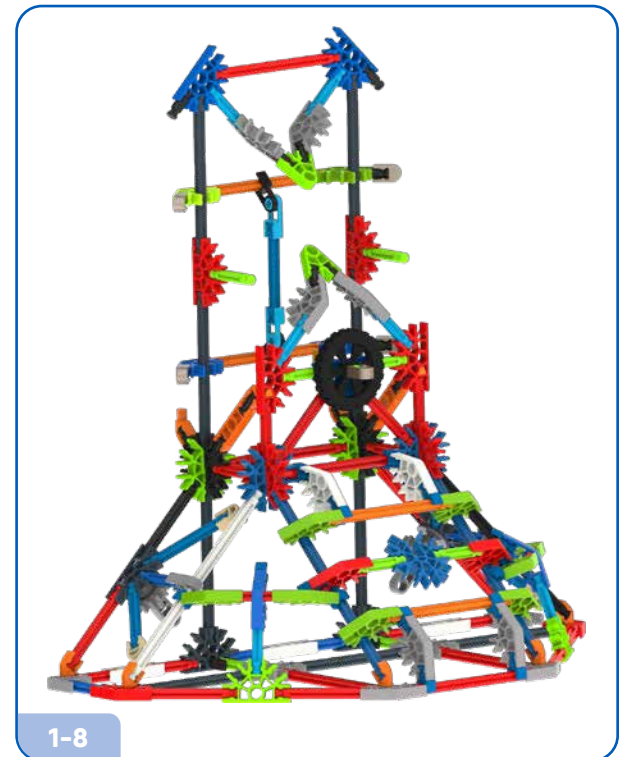

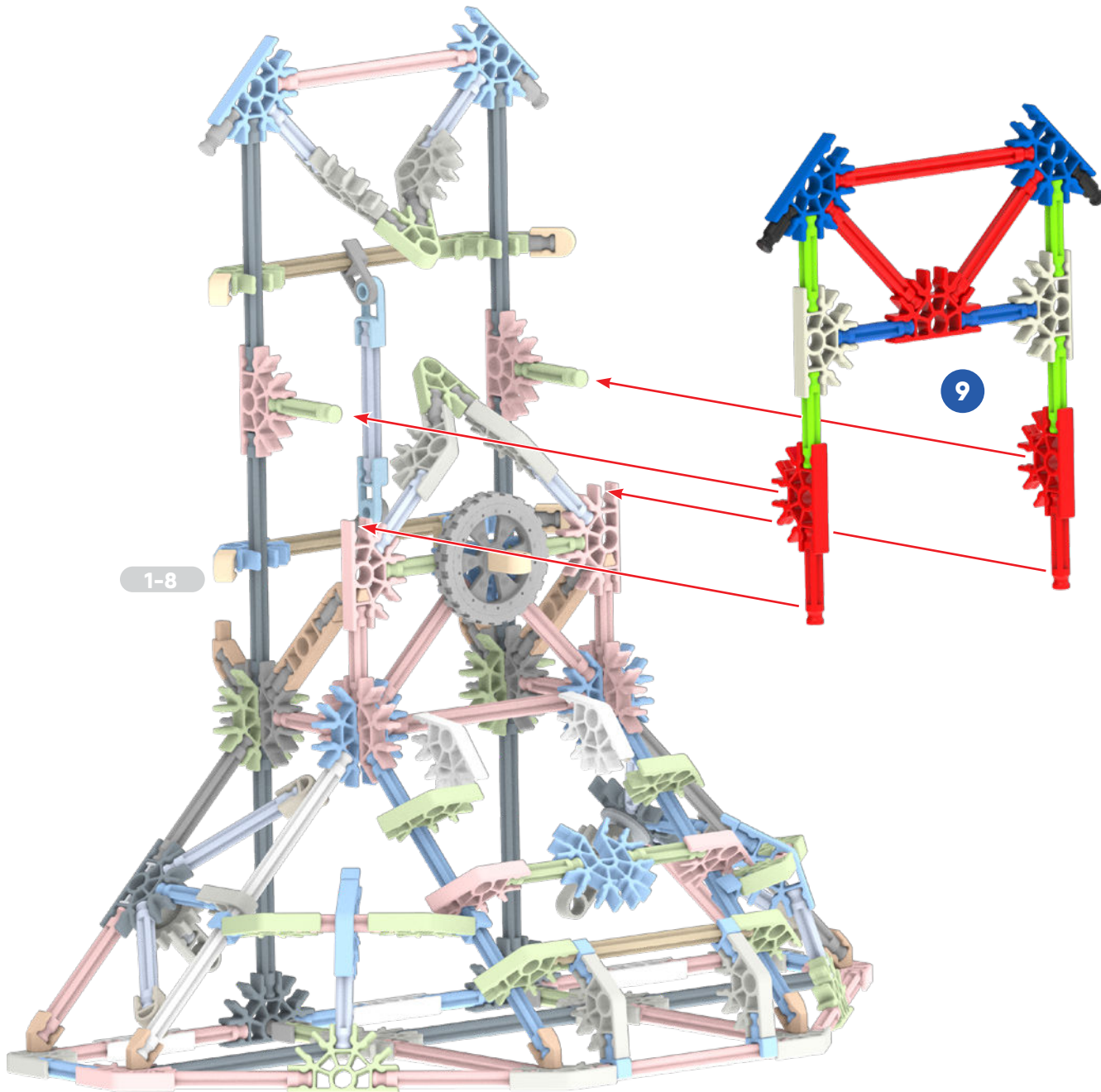

4		2	
	909512		90949
2		2	
	909514		909513
2		2	
	909524		90960
1		3	
	909533		909065

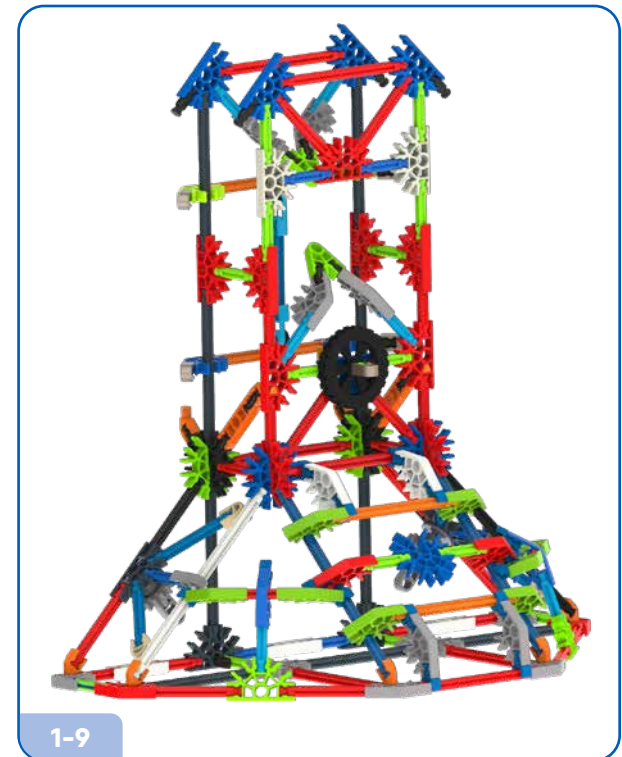

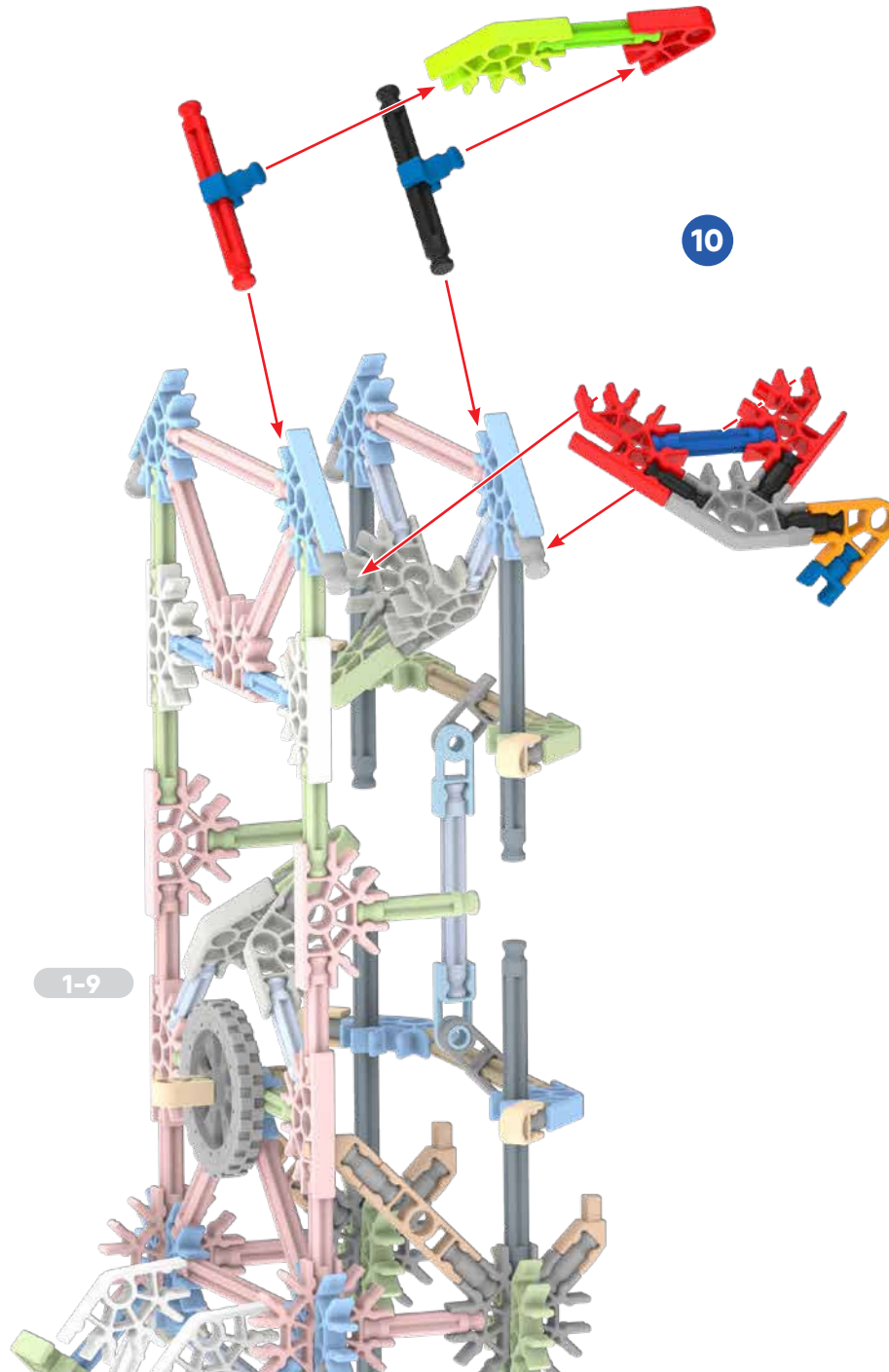
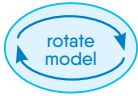

1	909513	3	90960	3	909142		
1	909512	1	91903	1	909032	2	909093
1	909524	1	909054	1	909055		
1	909523						



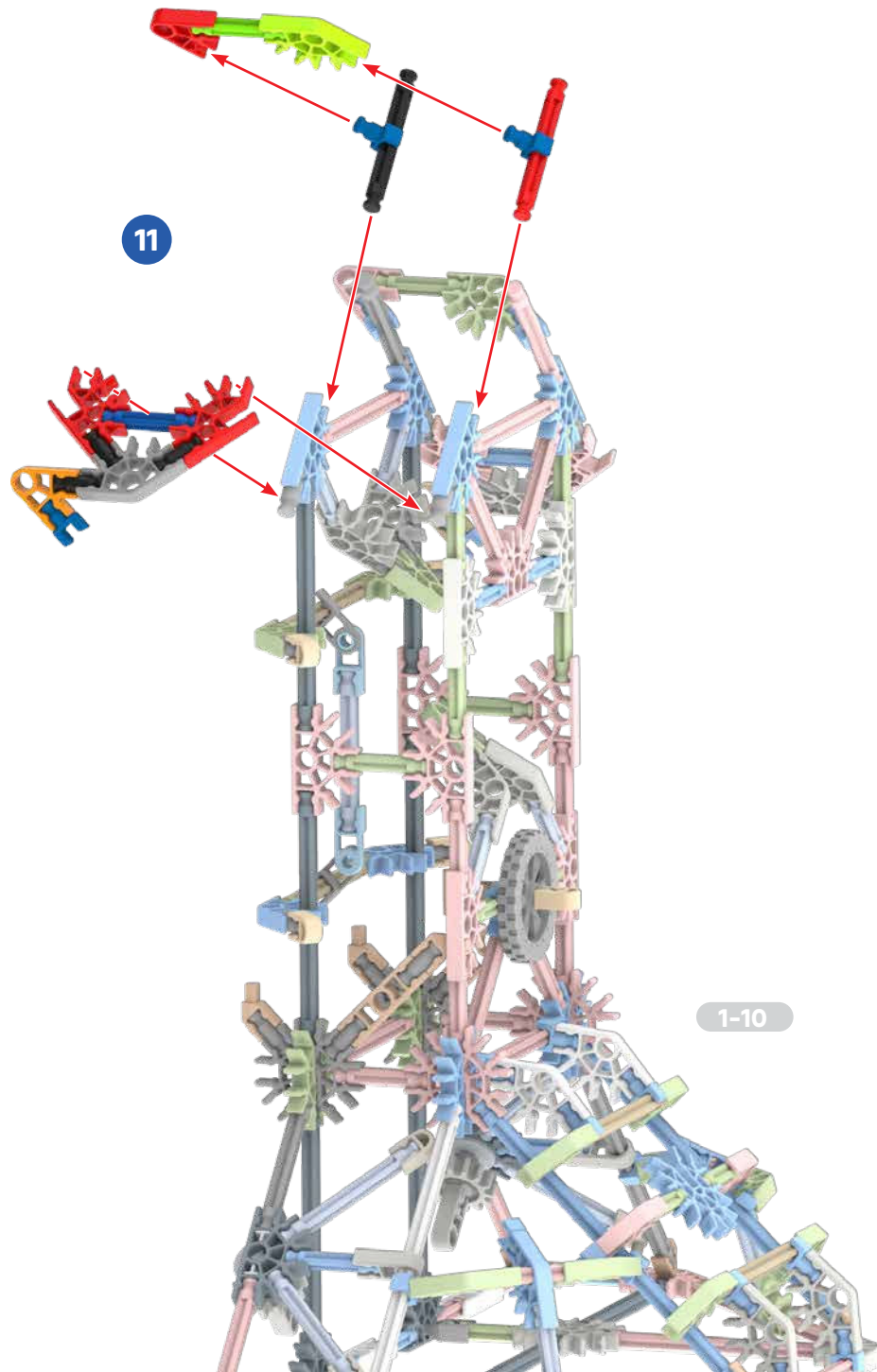
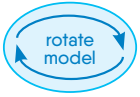

11

1-10

1	909513	3	90960	3	909142		
1	909512	1	91903	1	909032	2	909093
1	909524	1	909054	1	909055		
1	909523						



1-11

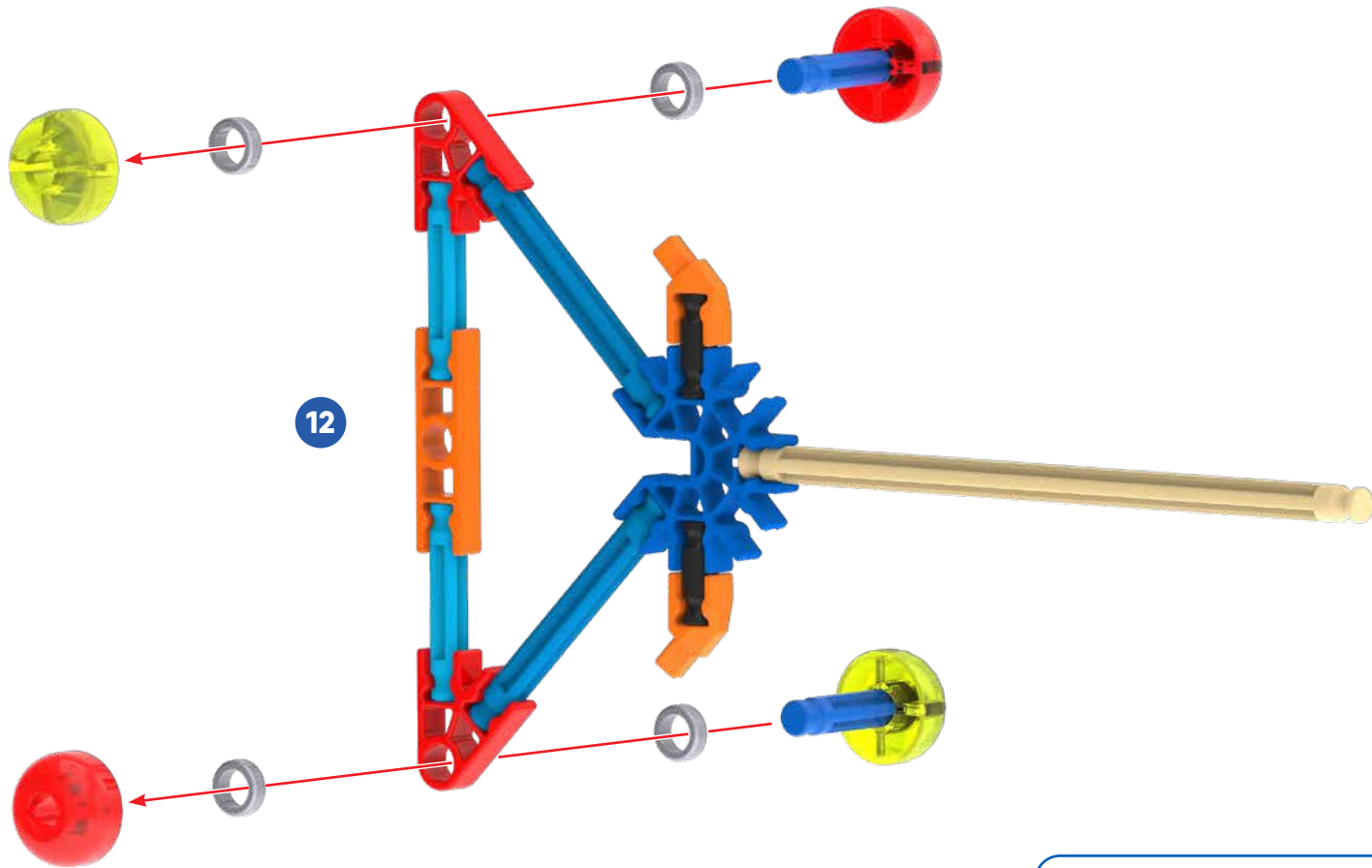

12

- | | | | | | |
|---|--------|---|--------|---|--------|
| 2 | 90960 | 1 | 90902 | 4 | 91994 |
| 2 | 914801 | 2 | 91920 | 2 | 91921 |
| 2 | 909513 | 2 | 909032 | 1 | 909074 |
| 2 | 91490 | 2 | 909032 | 1 | 909074 |
| 1 | 90957 | | | | |

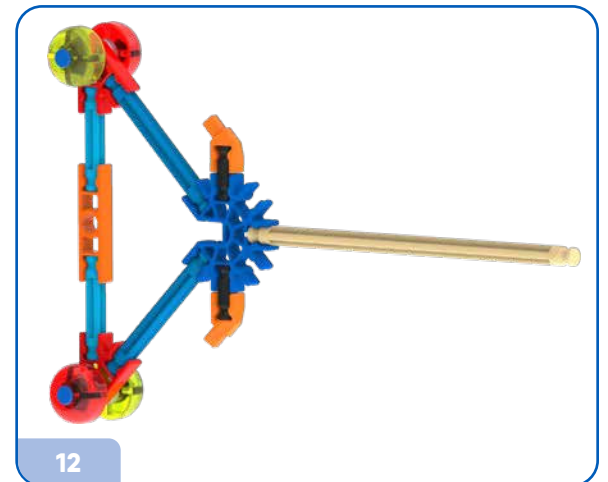

12

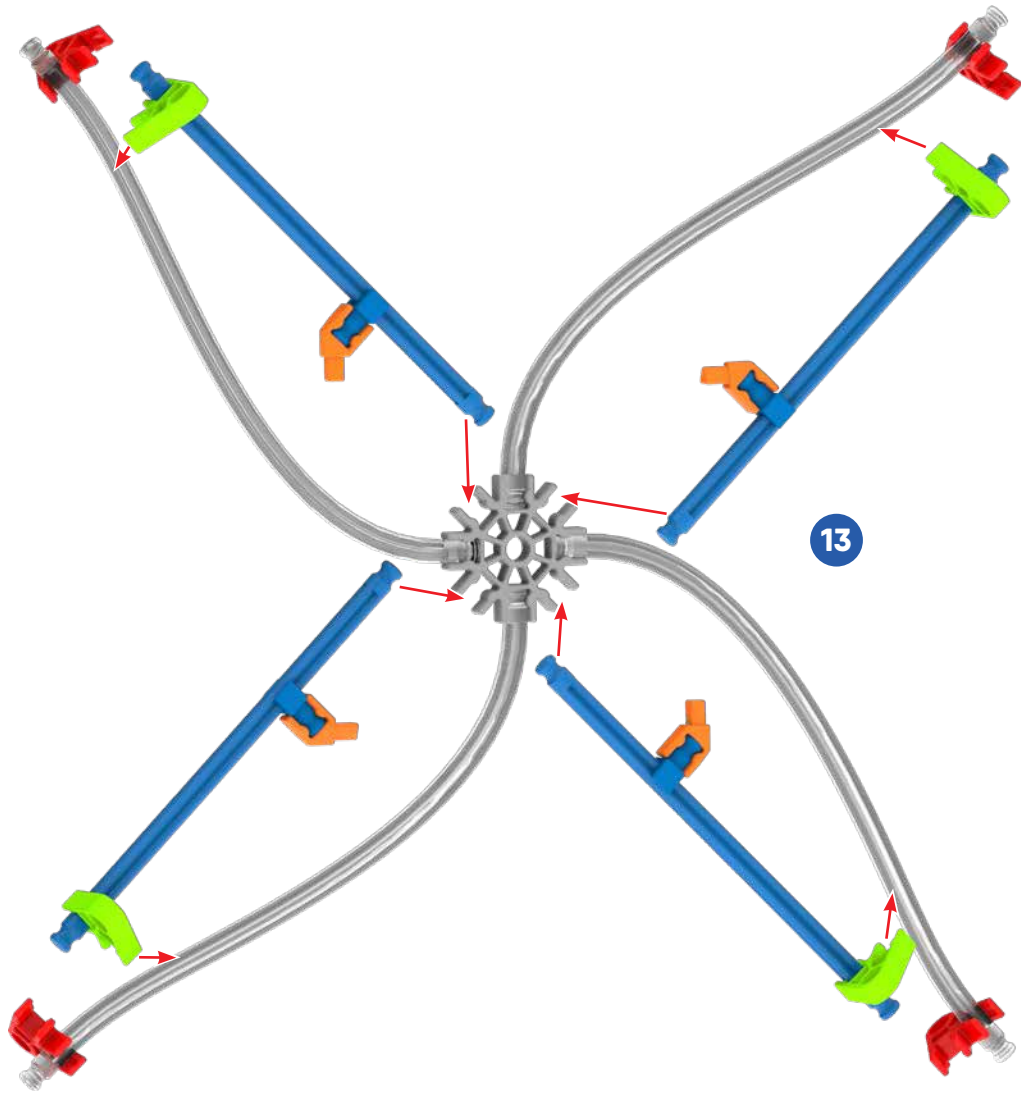

13

4 91690	4 909031	4 909032	4 909142	1 909081
4 92954			4 91100	

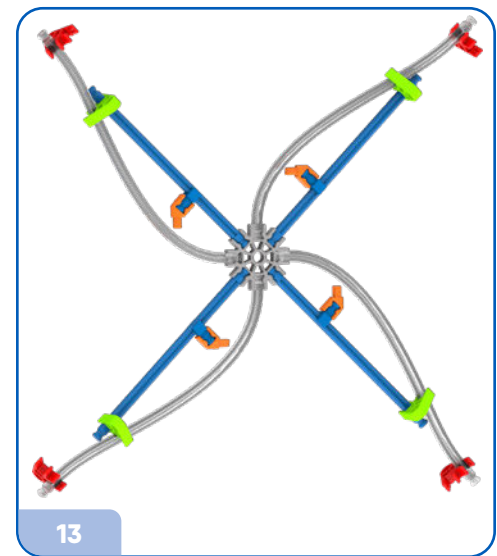

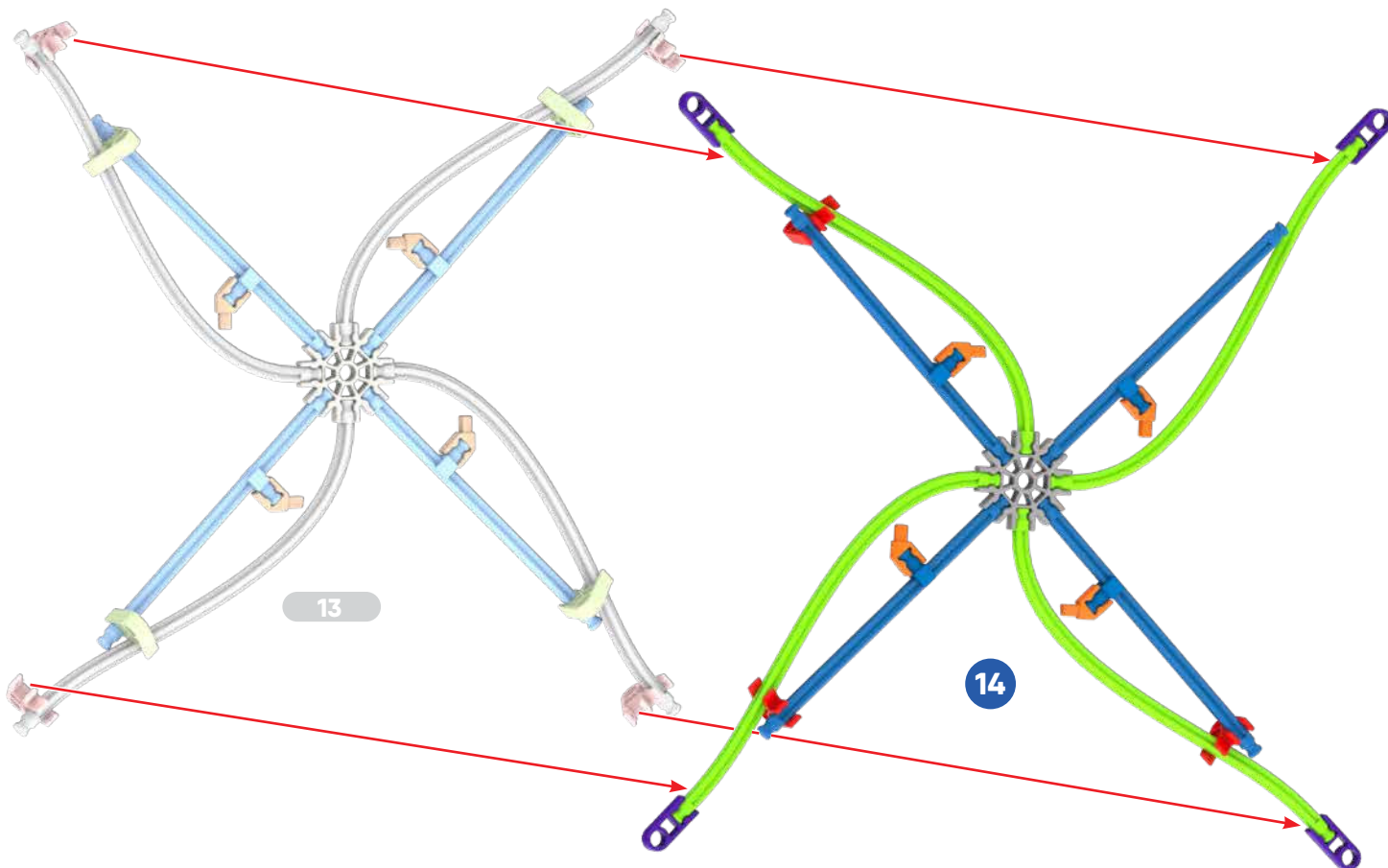

13

14

4 91690	4 909011	4 909032	4 909142	1 909081
4 92954				4 91108

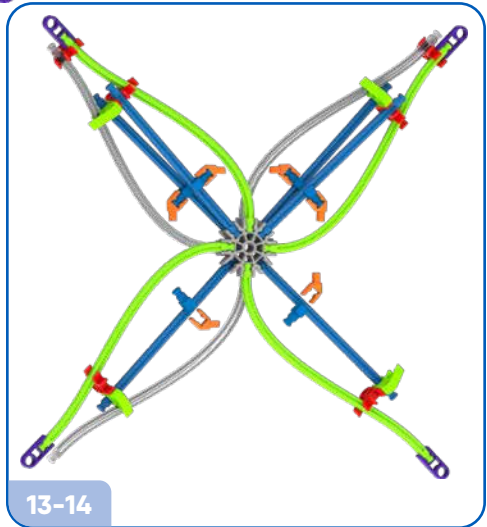

13-14

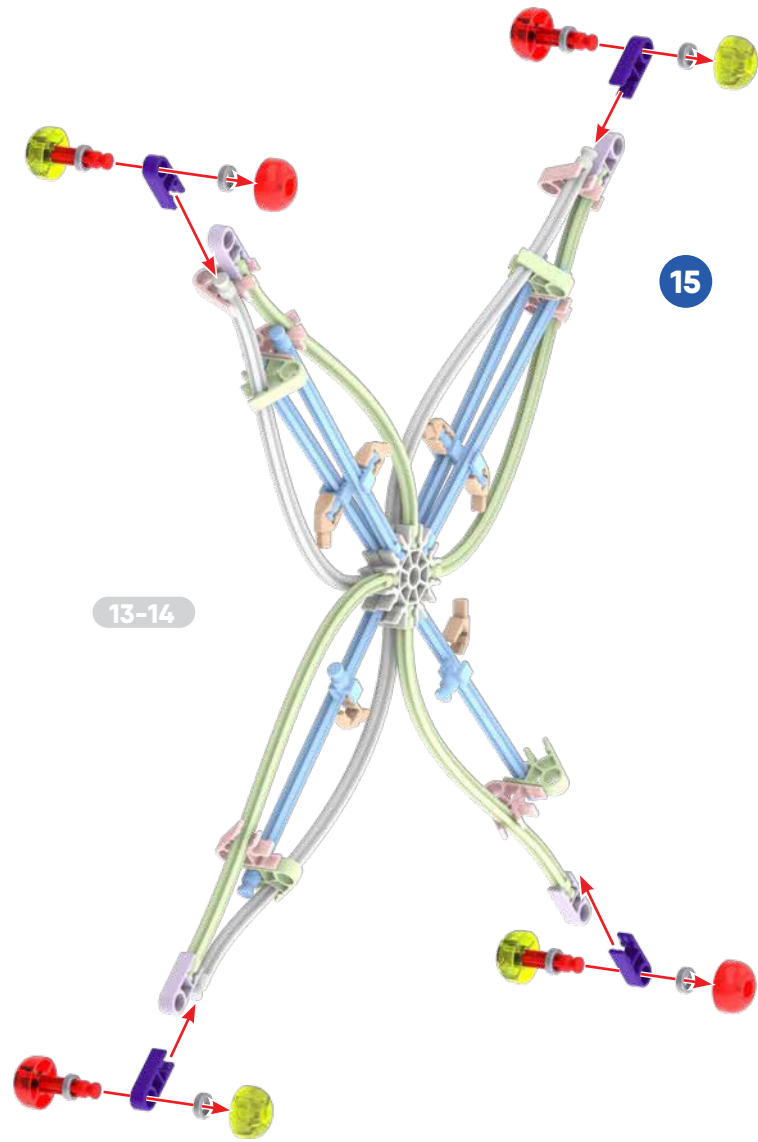

13-14

15

	8		91994
4		91920	
4		91921	
4		909514	
4		909011	

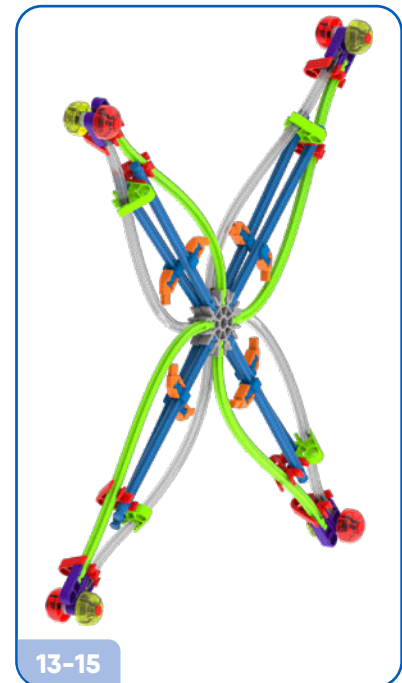

13-15

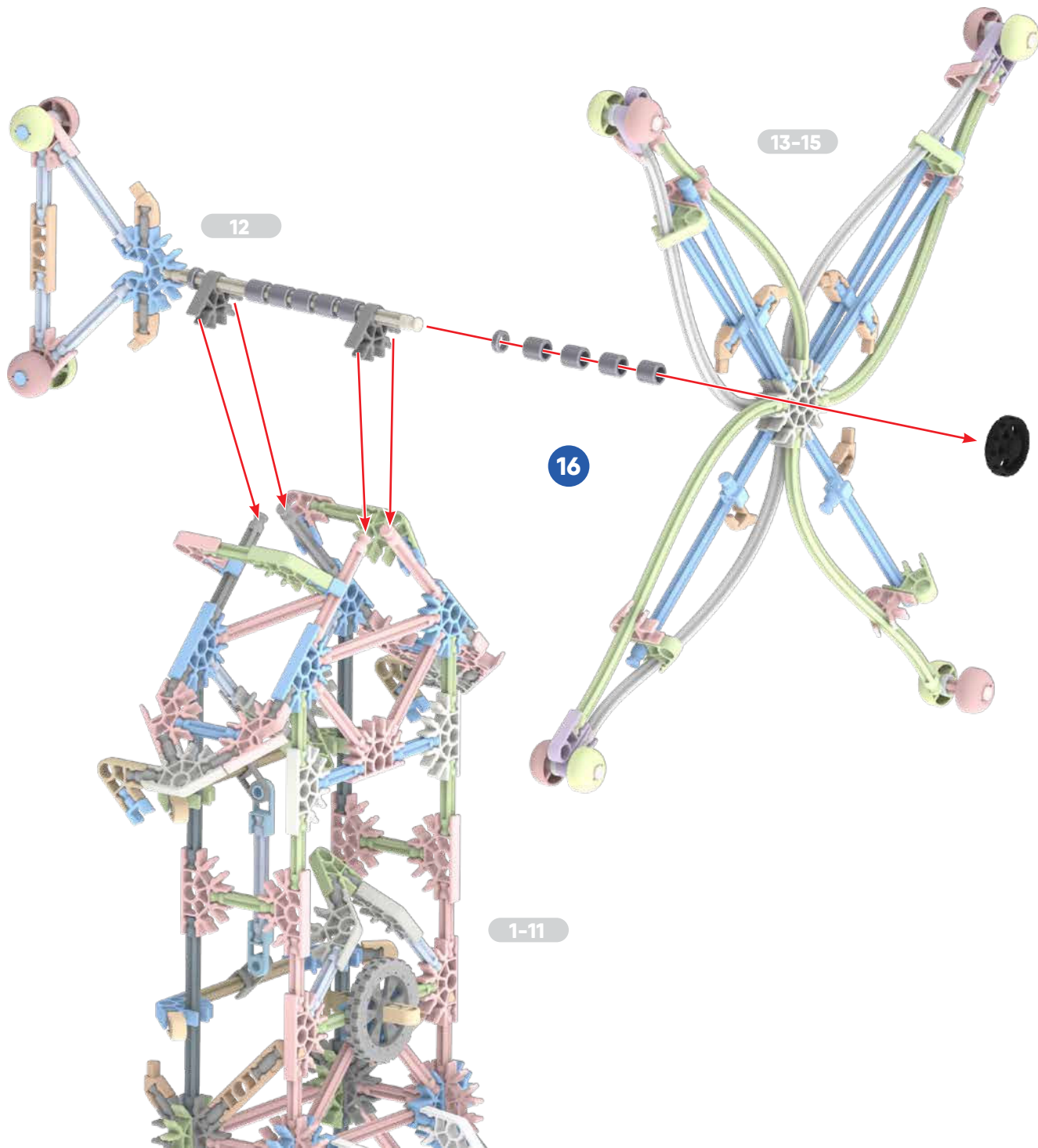

12

13-15

16

1-11

2 91994	1 918300
9 91224	2 909042

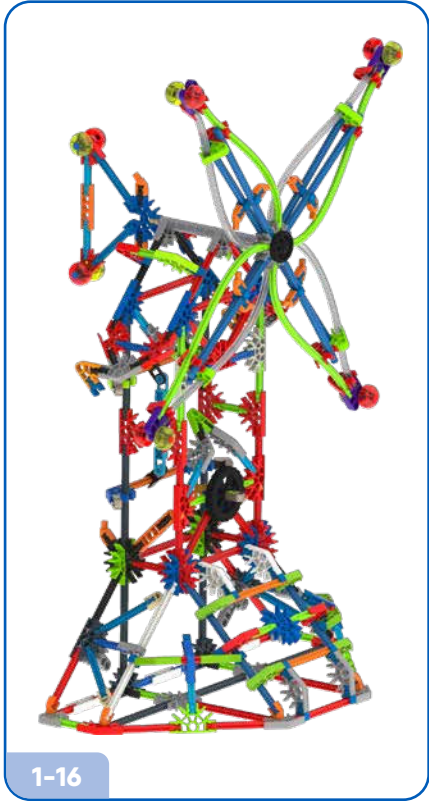

1-16

Race Track

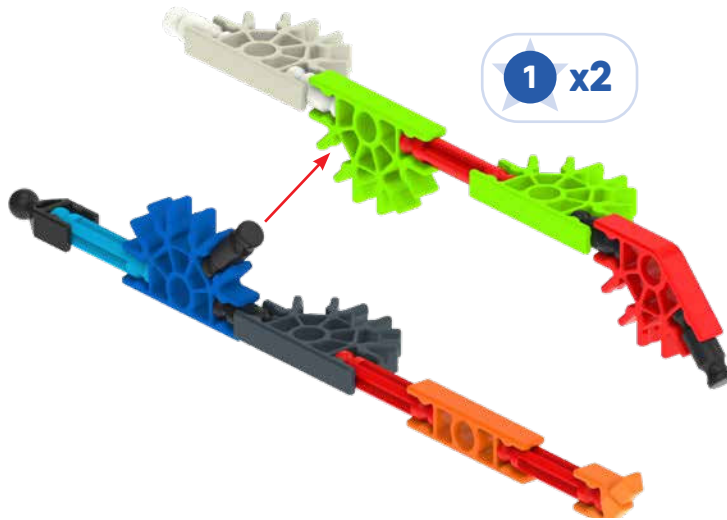
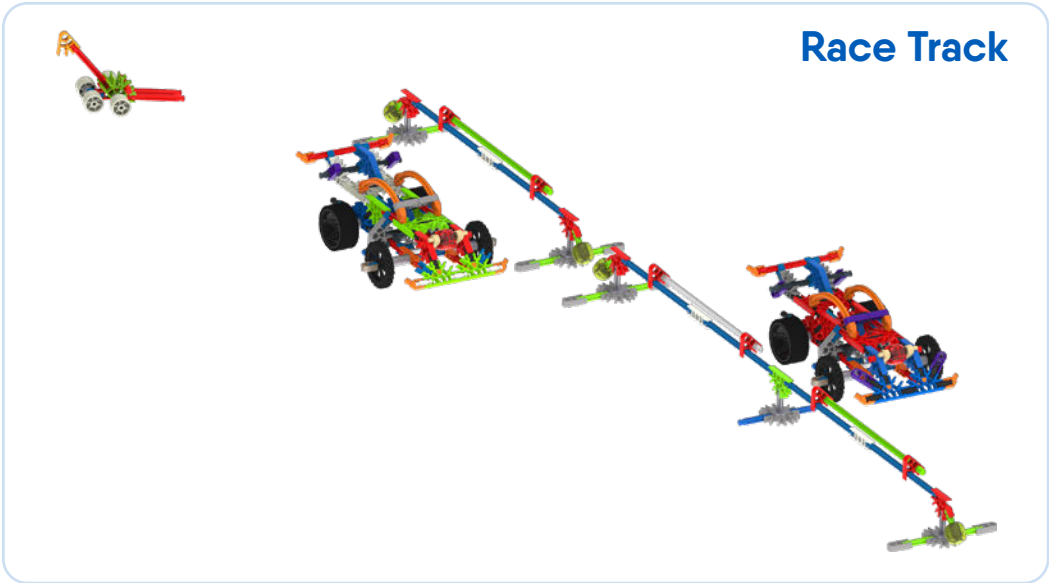

- | | | | | | |
|---|--------|---|--------|---|--------|
| 2 | 91690 | 2 | 90940 | 2 | 909057 |
| 8 | 90960 | 2 | 90902 | 2 | 909062 |
| 4 | 909503 | 2 | 90949 | 2 | 909063 |
| 2 | 914801 | 2 | 909063 | 4 | 909064 |
| 6 | 909514 | | | | |

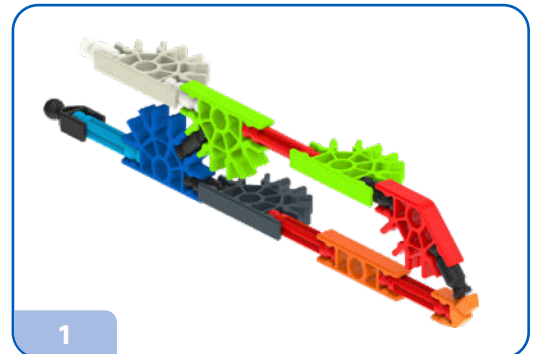

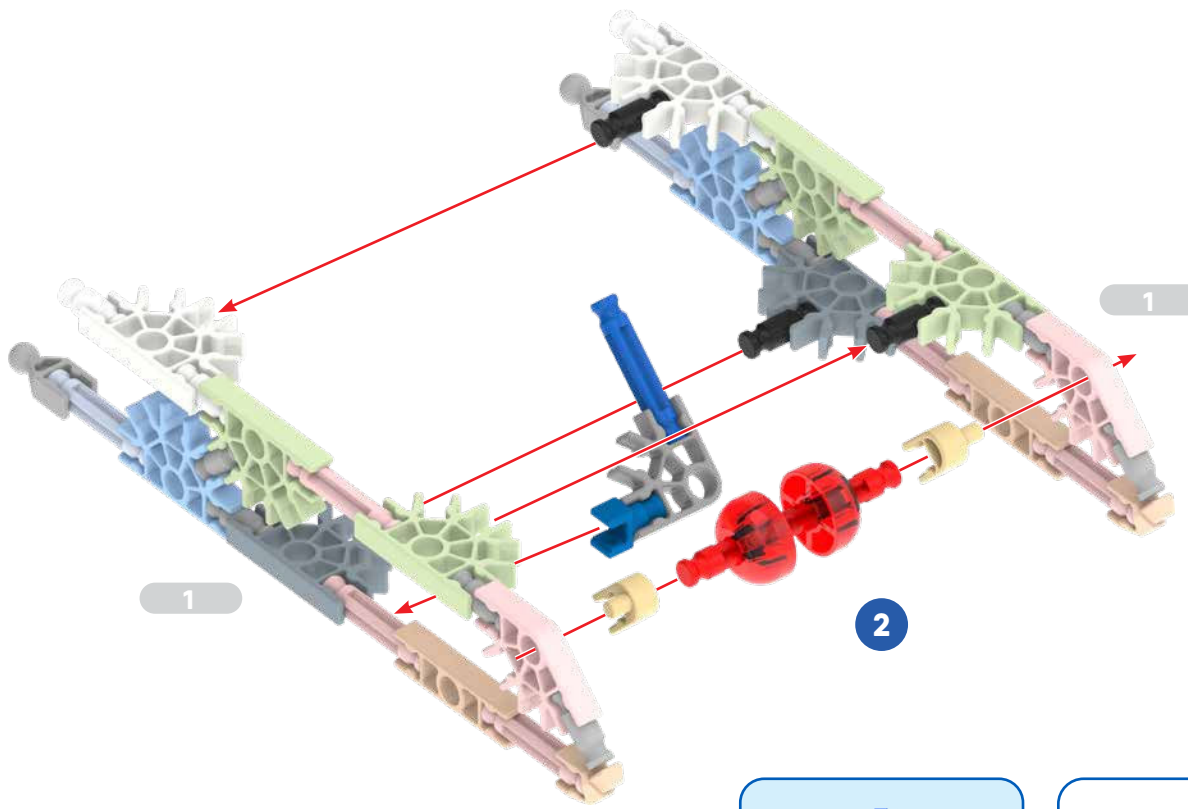

- | | | | | | |
|---|--------|---|--------|---|--------|
| 3 | 90960 | 1 | 909142 | 2 | 91920 |
| 1 | 909513 | 2 | 90900 | 1 | 909042 |
| 1 | 909524 | | | | |

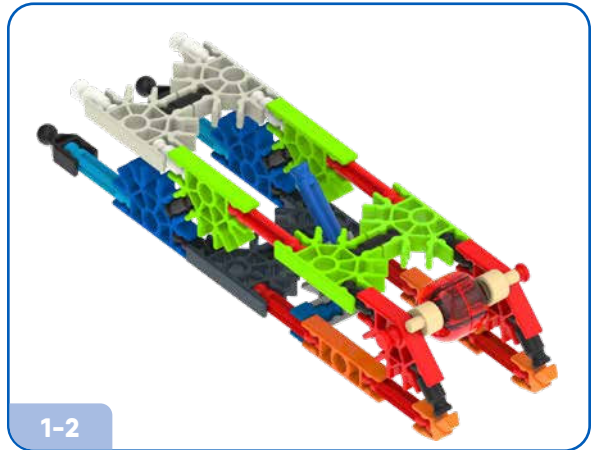

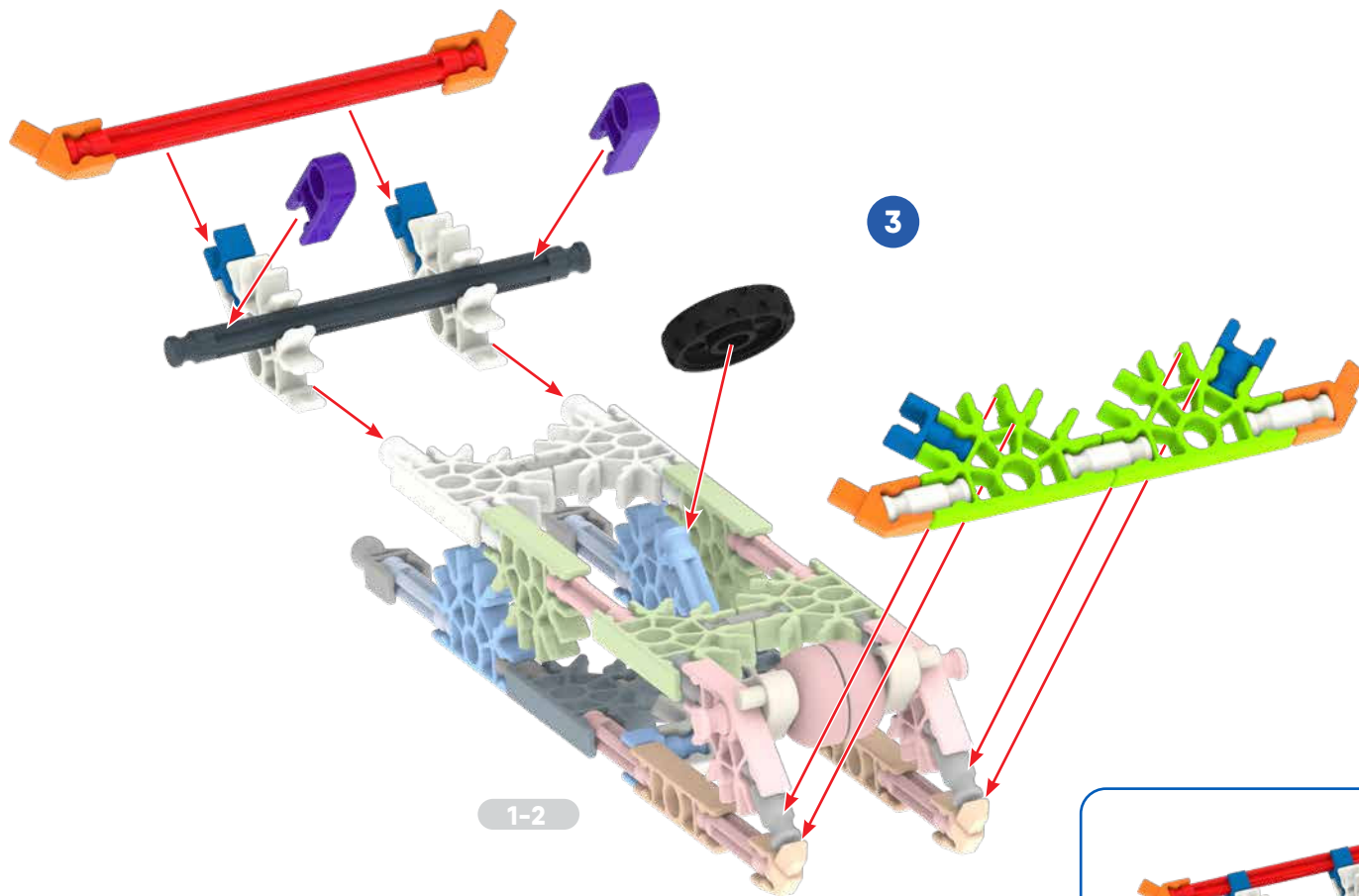

1-2

3

3	4	4	2	1	
909503	91690	909142	909011	918300	
1					
		909533			
1		909532	2	2	
			909059	909064	



1-3

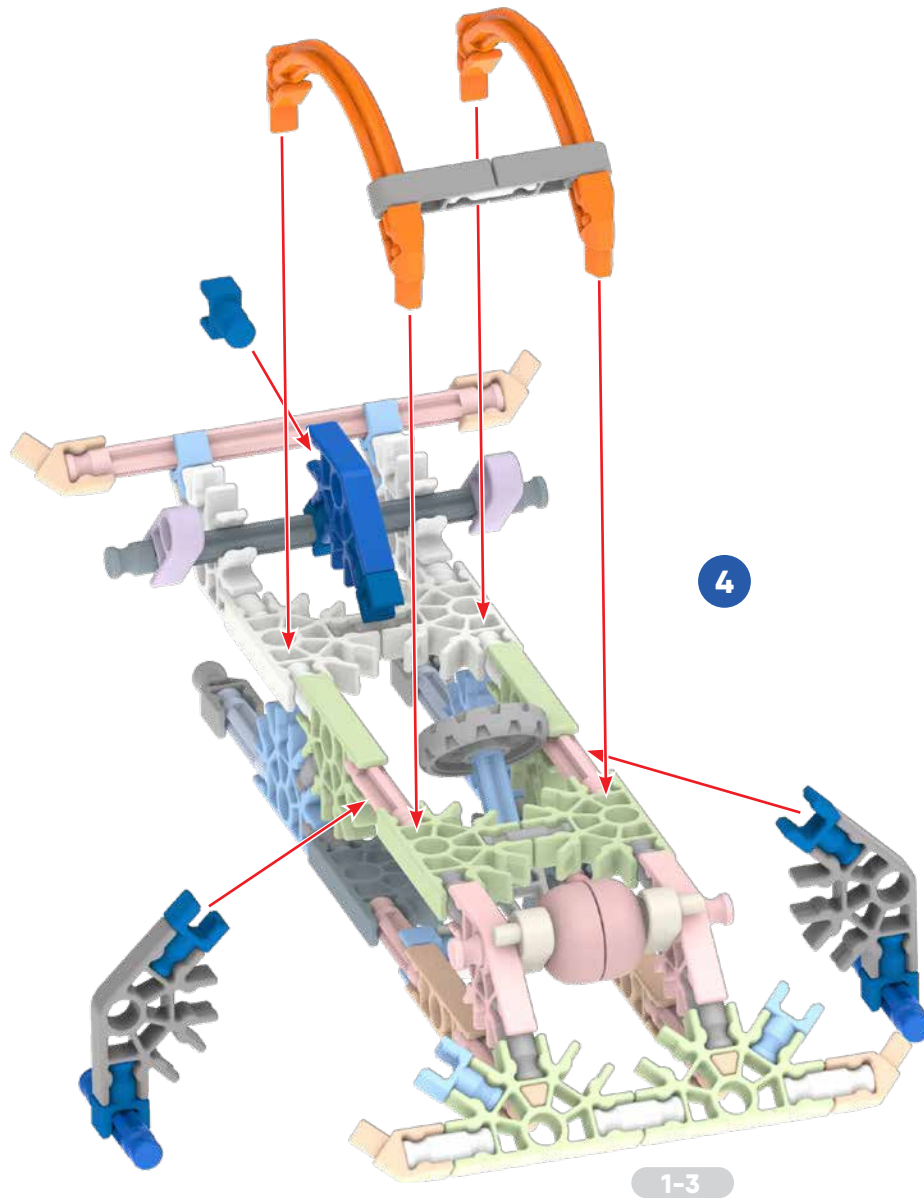

1	4		
909503	91690	2	2
2	7	909012	909055
909513	909142		
2		1	
	91282	909056	

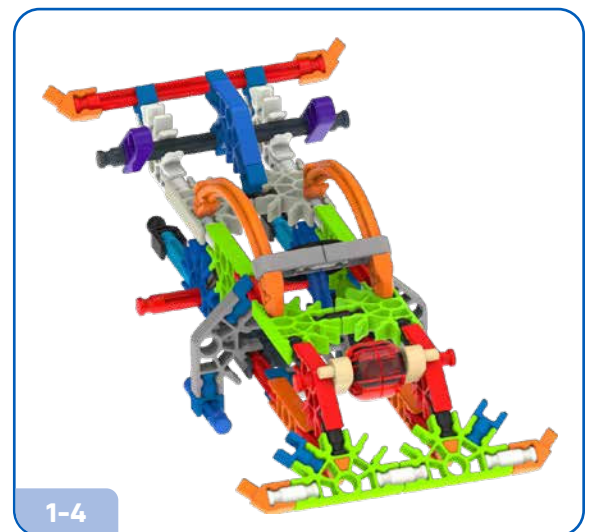

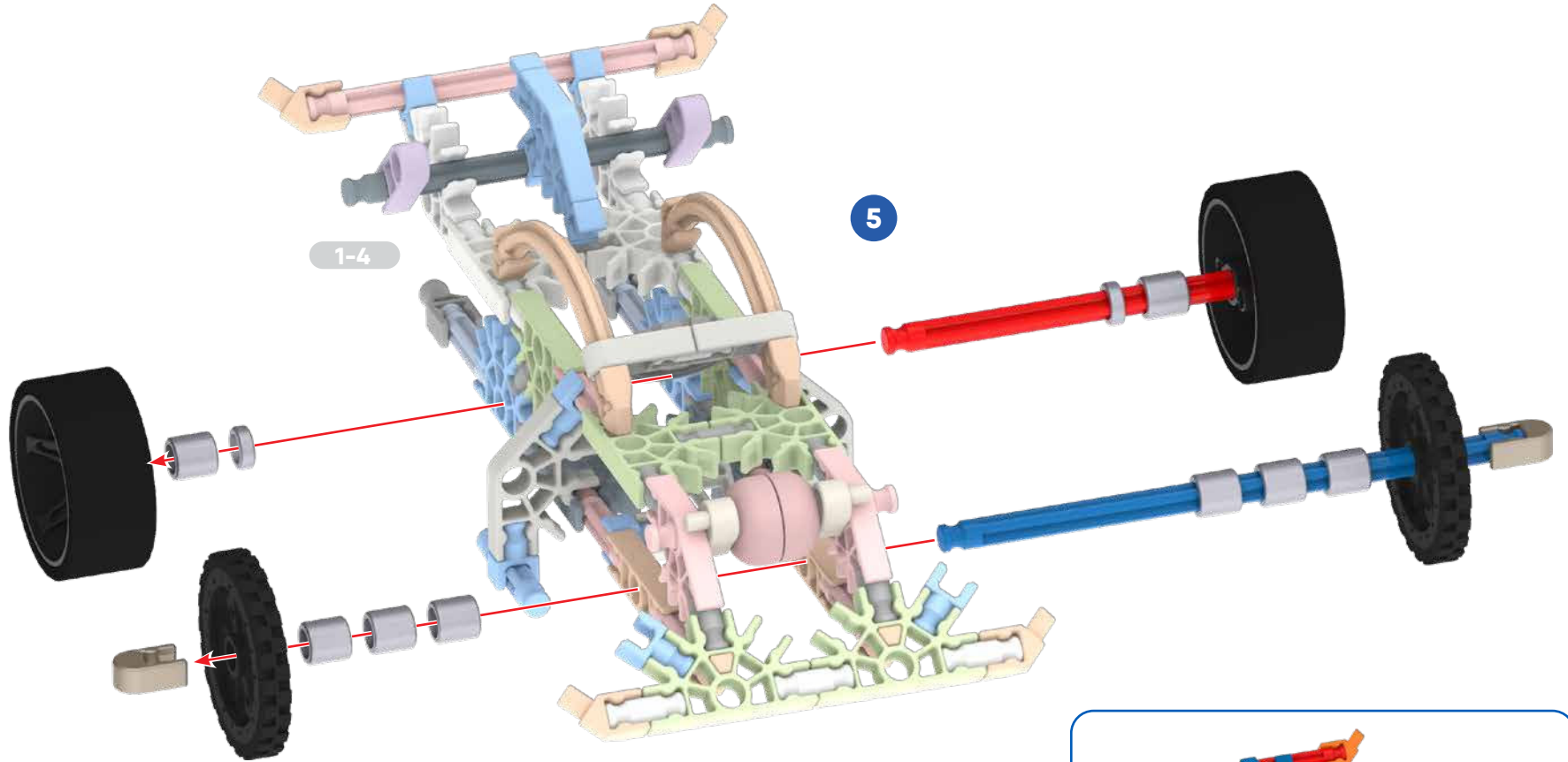

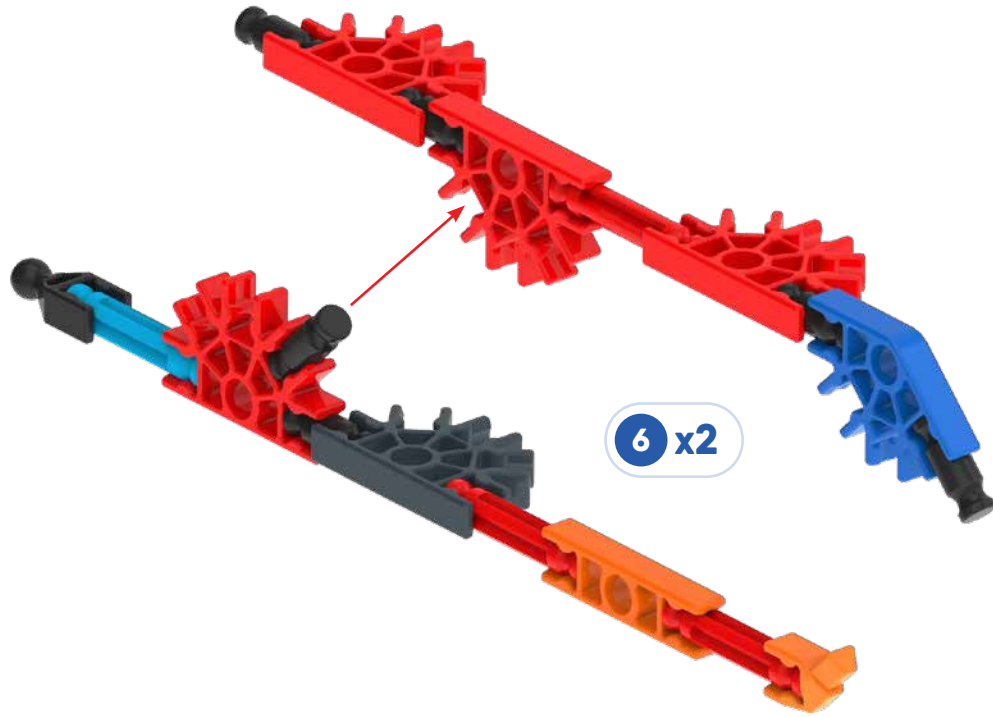

6 x2

2 91690	2 90940	
12 90960	2 90902	2 909056
2 914801	2 909062	8 909065
6 909514		

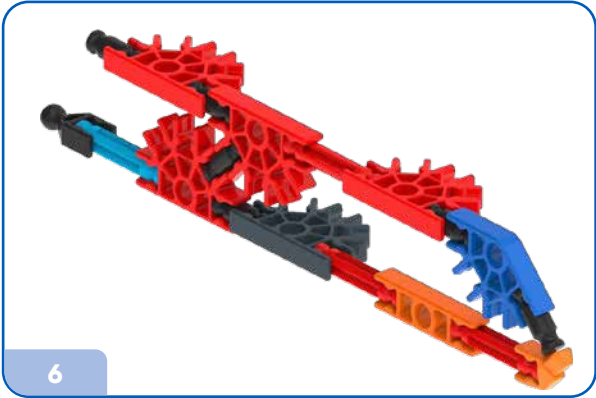

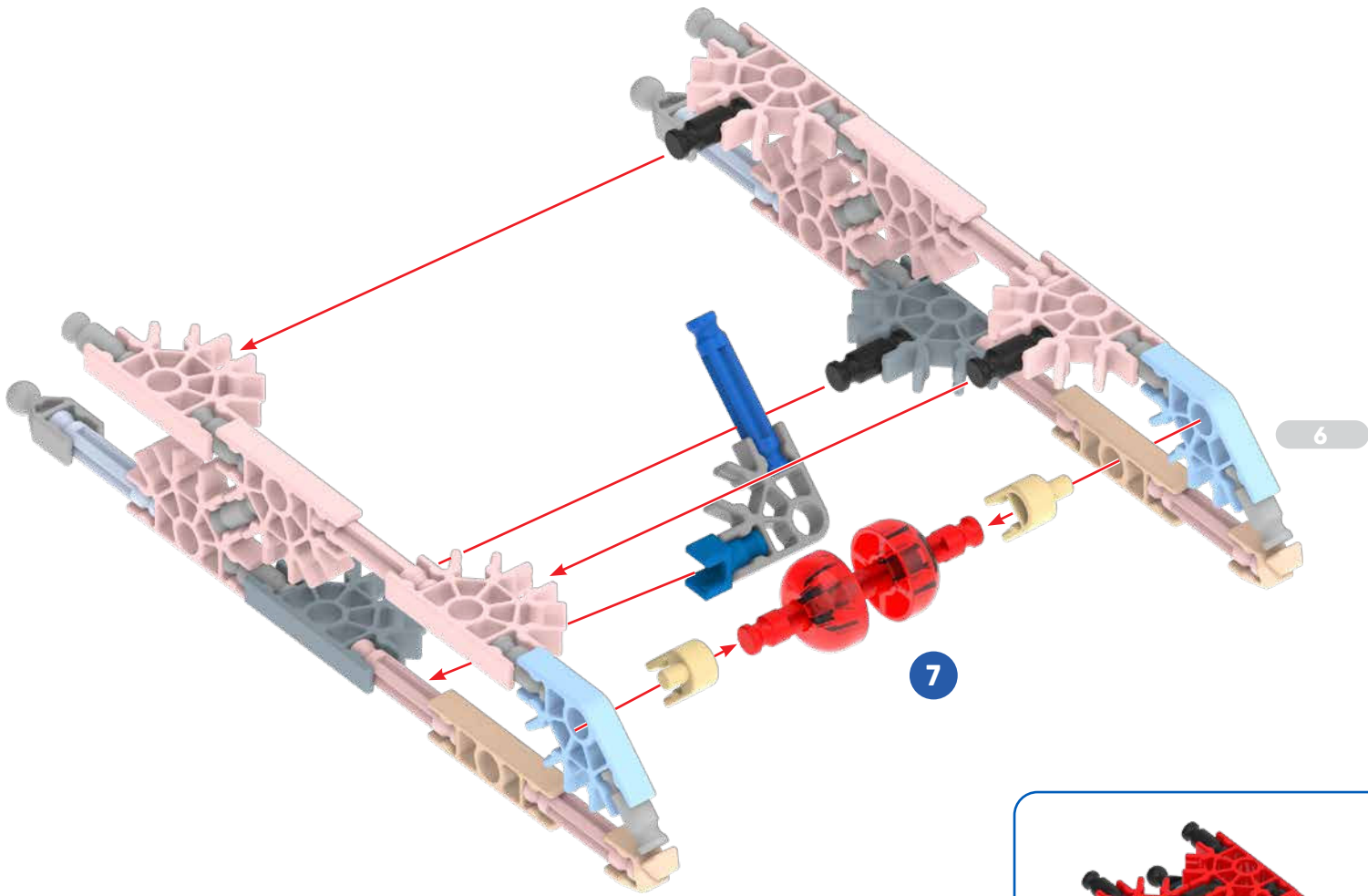

- | | | |
|--------|--------|--------|
| 3 | 2 | 2 |
| 90960 | 90900 | 91920 |
| 1 | 1 | 3 |
| 909513 | 909142 | 909042 |
| 1 | | |
| 909524 | | |

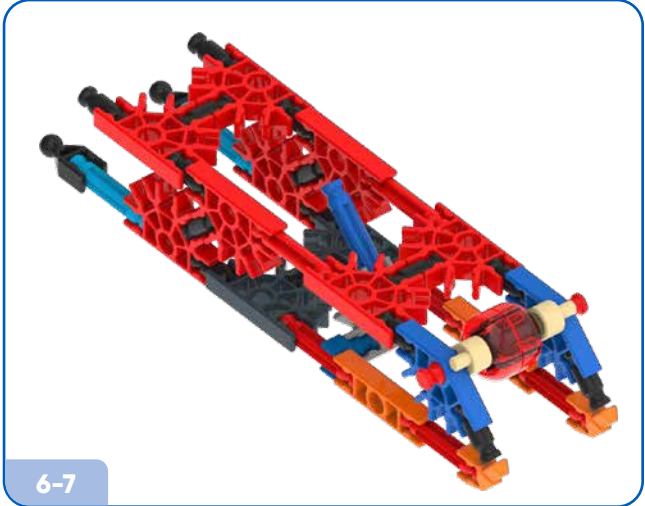

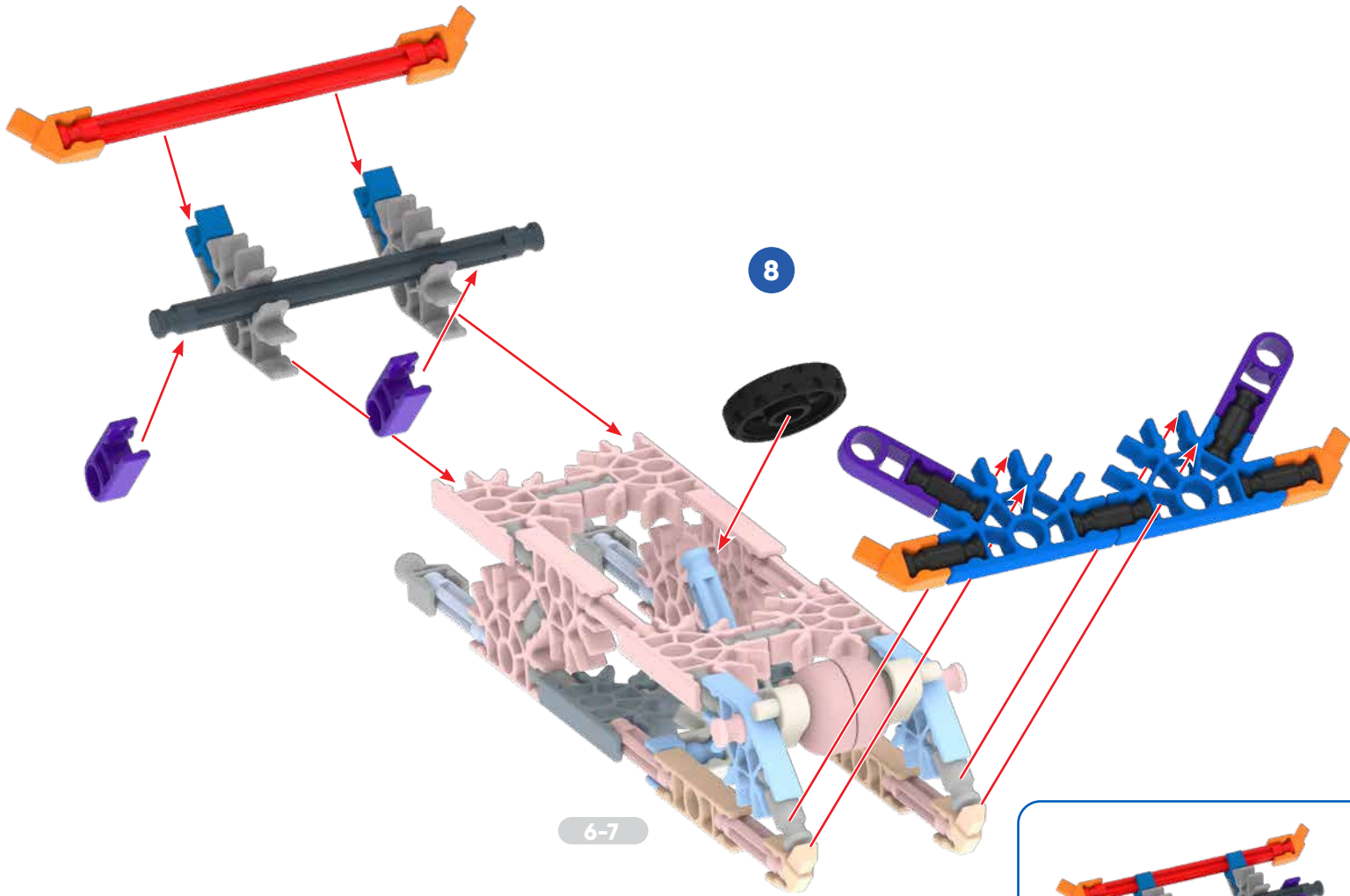

6-7

5	4	2	4	1
90960	91690	909142	909011	918300
1		909533		
1		909532	2	2
			909055	909063



6-8

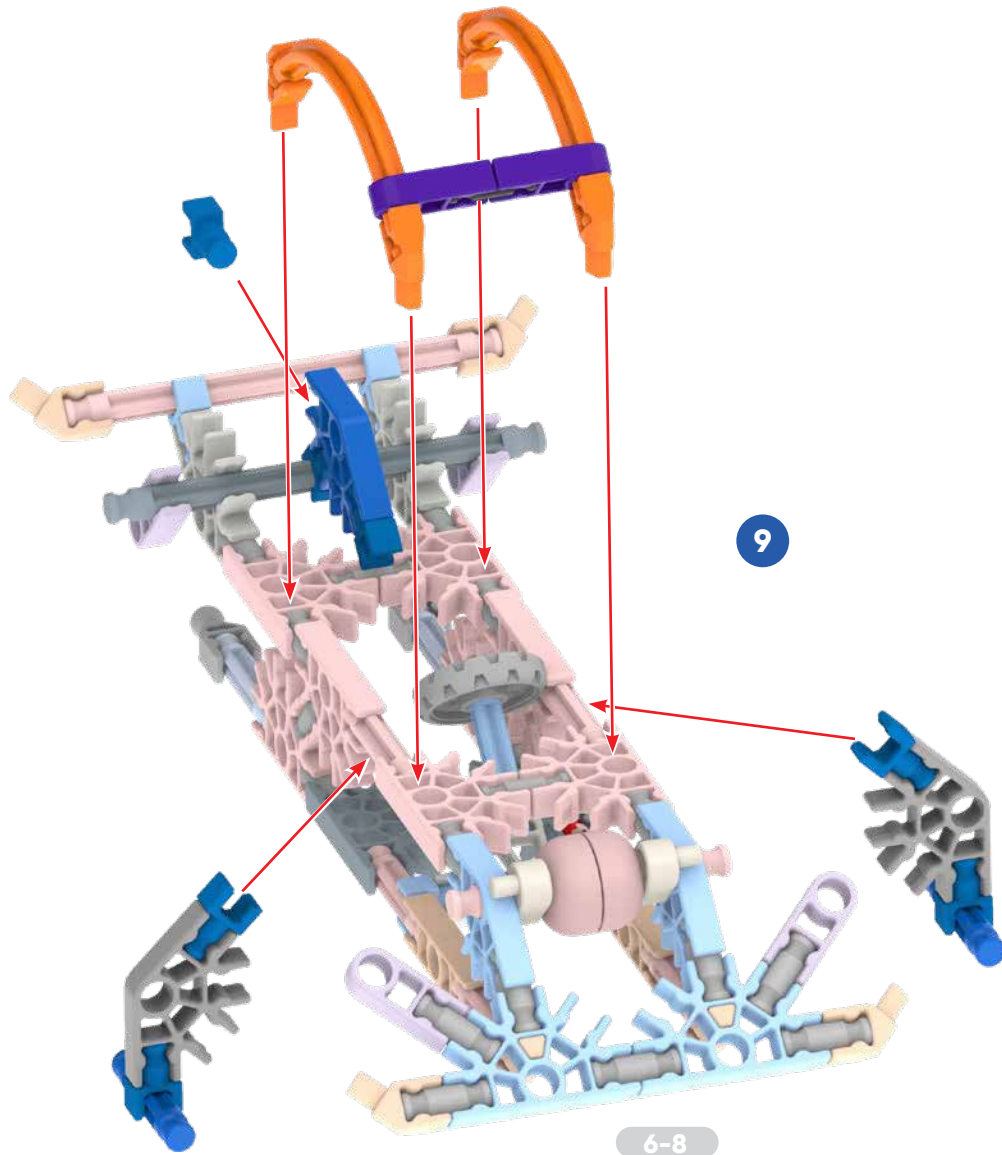

9

6-8

1 90960	2 909011	7 909142	1 909056
2 909513	4 91690	2 91282	2 909055



6-9

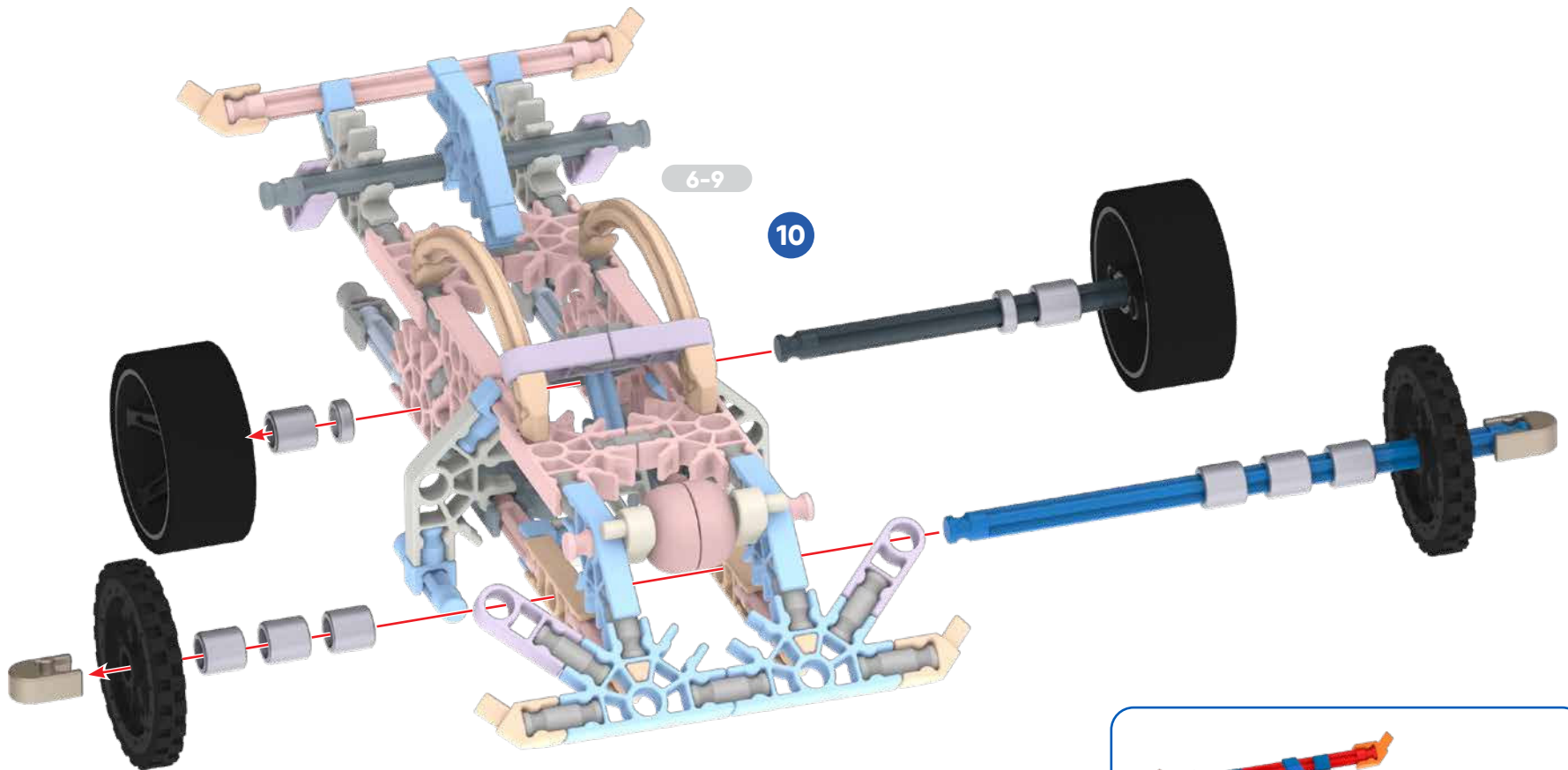

2	2	8	2	2
914401	91994	91224	919780	91170
1	909532		2	2
1	92954		91975	91380

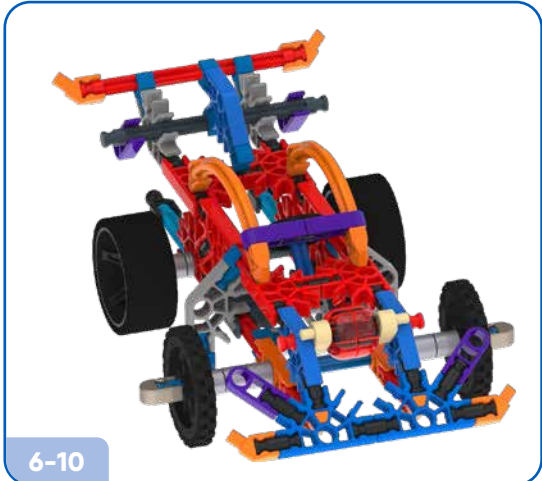

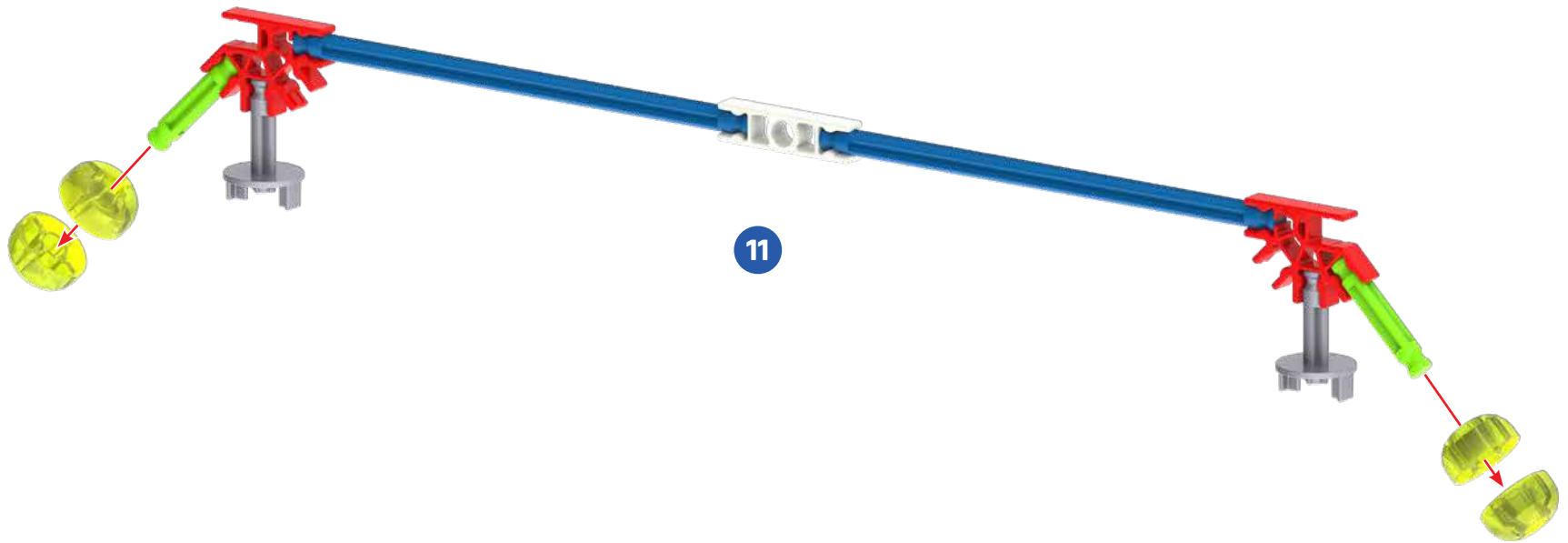

11

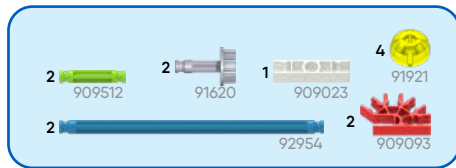

11

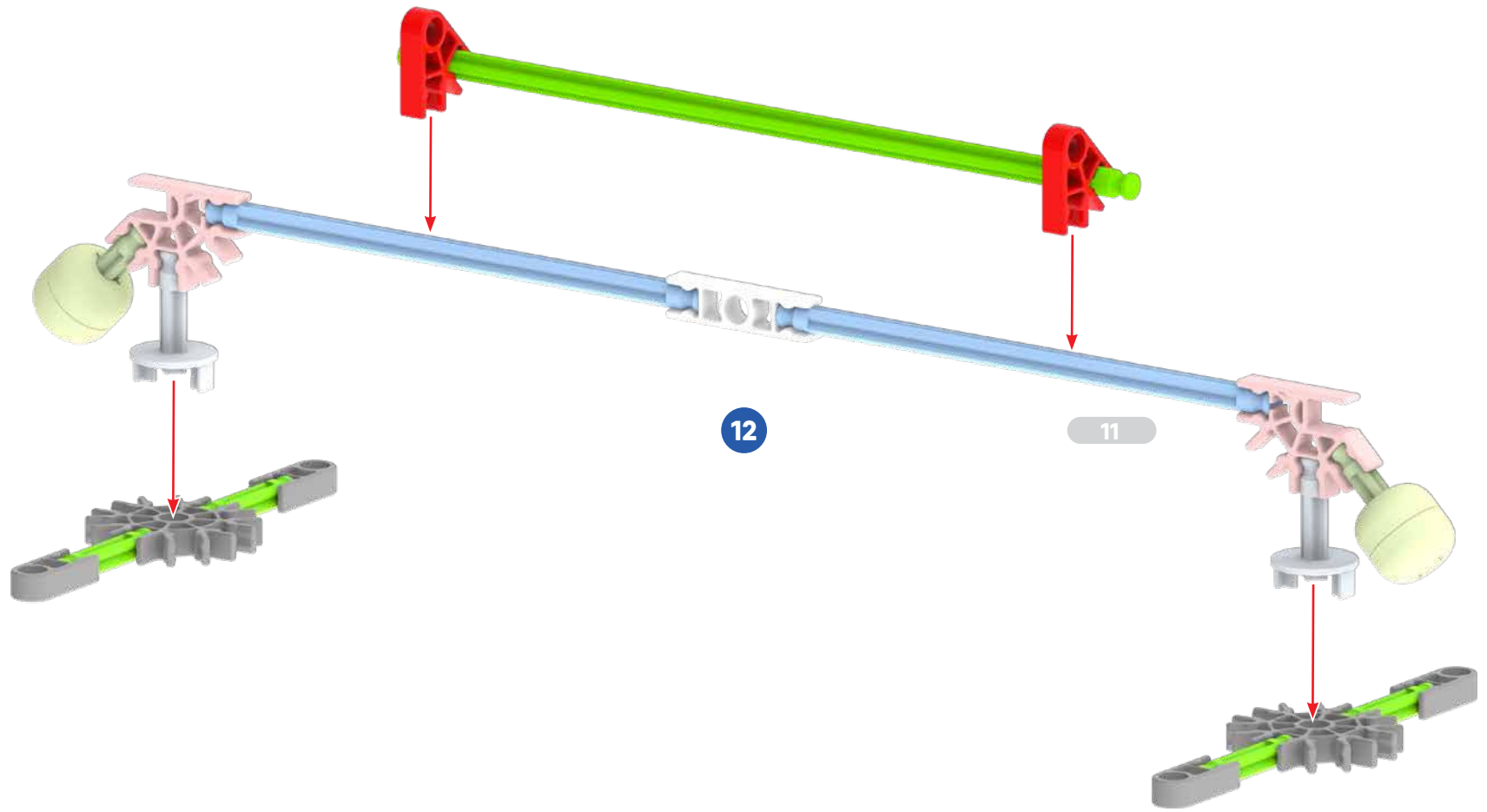

4		4		2		2	
	909512		909012		909032		909081
1							
							91108



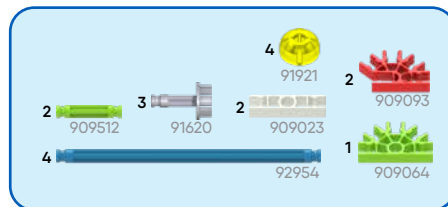
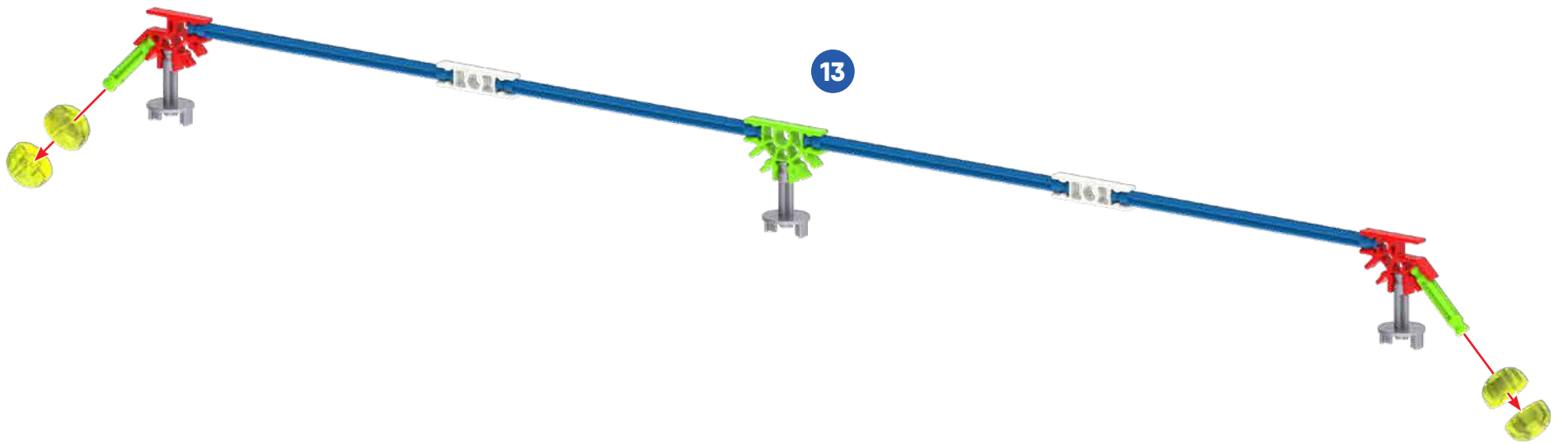

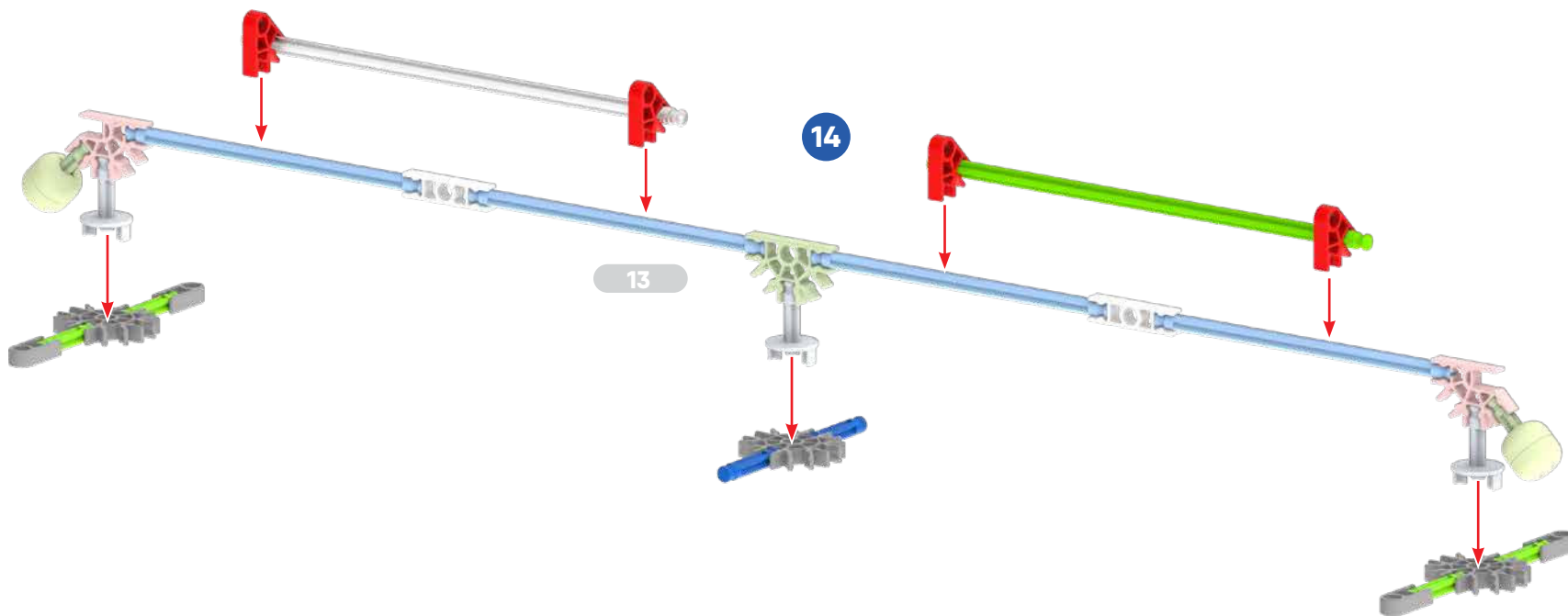

- | | | | | | | | | | | | |
|---|--|--------|---|--|--------|---|--|--------|---|--|--------|
| 2 | | 909513 | 4 | | 909012 | 4 | | 909032 | 3 | | 909081 |
| 1 | | 91100 | 1 | | 91108 | | | | | | |

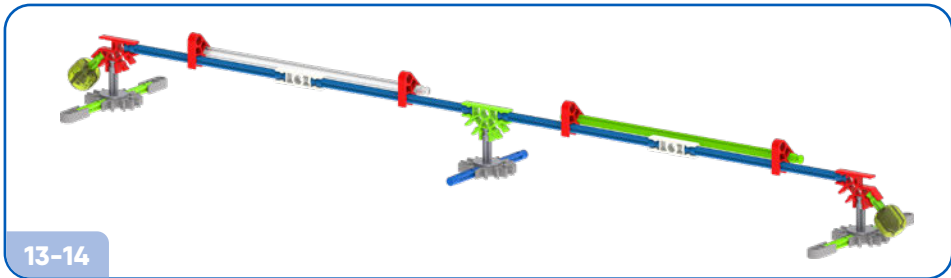

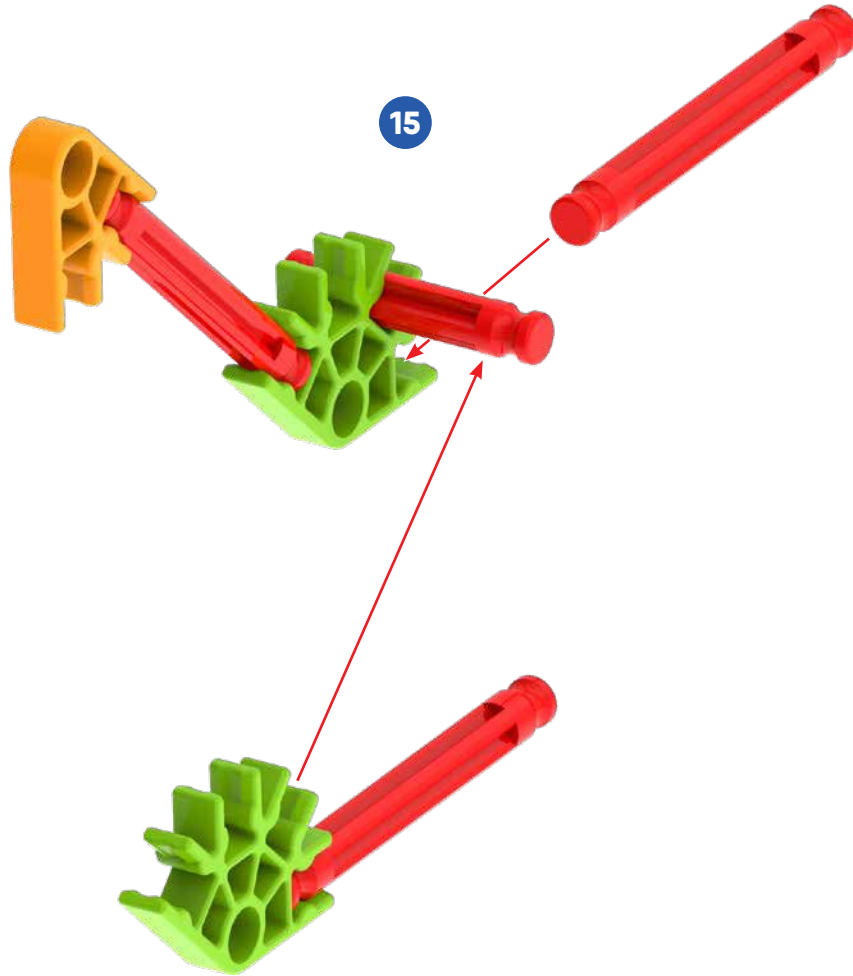

15

1		1	
	909514		91903
3		2	
	909524		909053

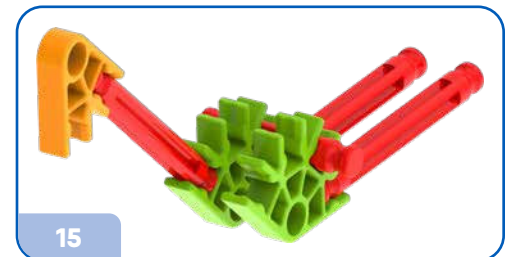

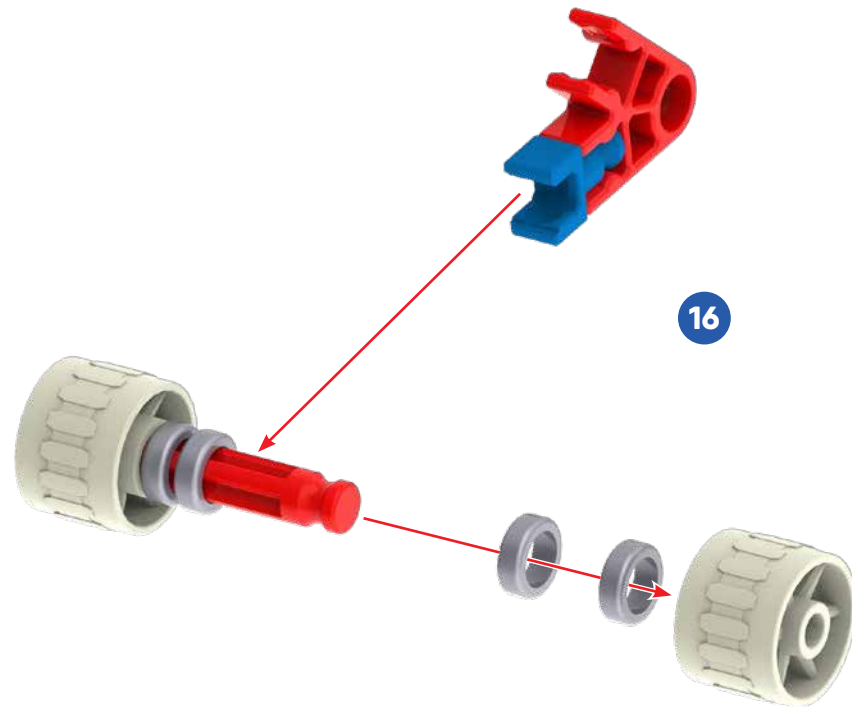

4		2	
1		1	
1		1	
	91994		531204
	909142		
	909514		909032

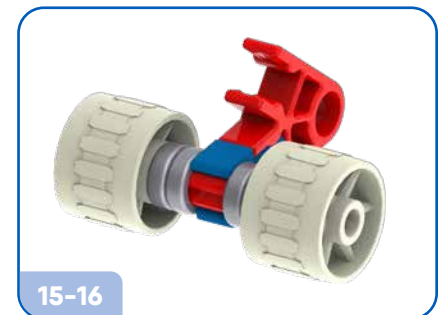

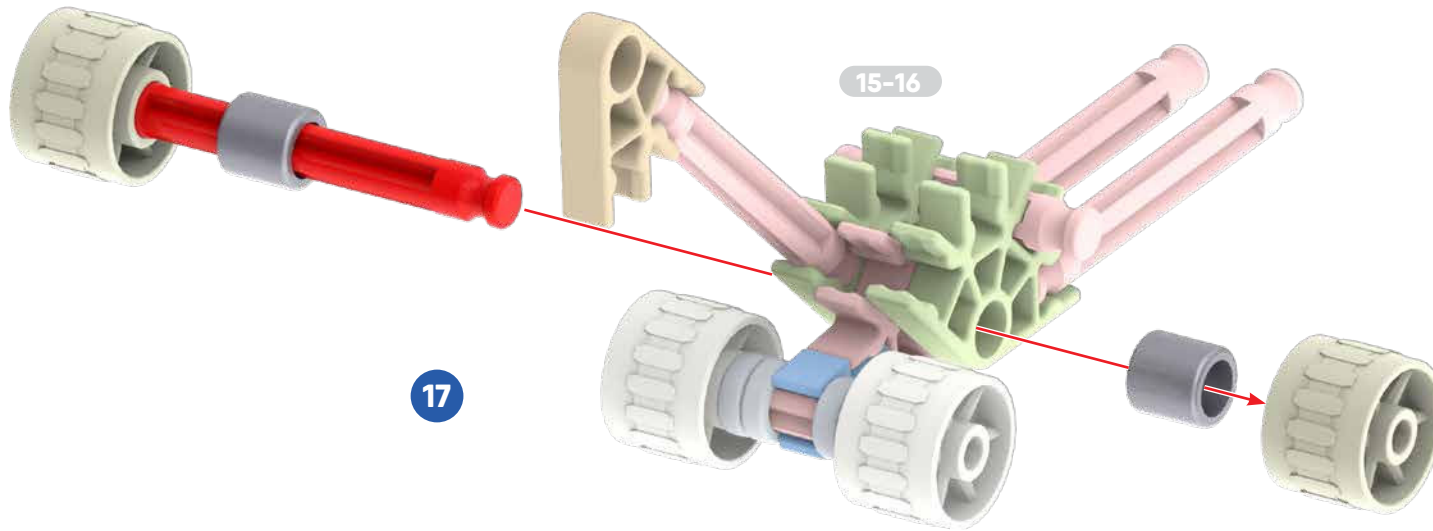

2		2	
	91224		531204
1			
			909524





15-17



18

1-5

11-12

6-10

13-14