

K'nex

85043



MOTORIZED MODELS Building Set

7+

1051 PIECES | **86** BUILDS



+MORE



You Build It!

**MOTORIZED
MOVEMENT!**



MOTORIZED

Motor
Included

2x **AA(LR6)**
Not Included

WARNING:
CHOKING HAZARD – Toy contains a small ball
and small parts. Not for children under 3 years.

BONUS VALUE!

35 Additional Builds!



522 Additional Pieces!





STEAMAGINATION®

You'll find it in every K'NEX Set. STEAM stands for **Science, Technology, Engineering, Arts & Math** and when it's connected with imagination, building dreams becomes fun-powered 3D reality. The journey to WOW begins with a single click.





Building Basics

Start Building

Look at the pictures, find the pieces in your set that match and then connect them together. Try to face your model in the same direction as the instructions while you build. The arrows show you where the parts connect, but not all connection points have arrows. Faded colors show you this section is already built.

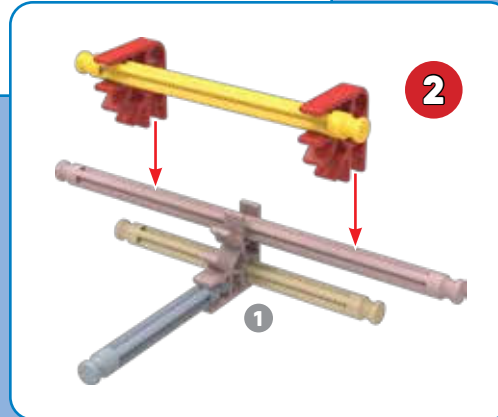
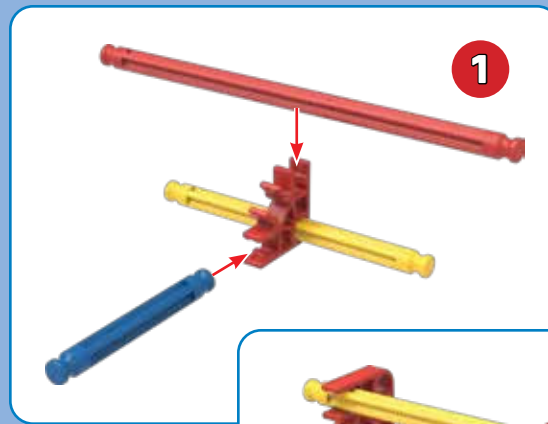

Connectors

Push these special connectors together tightly until you hear a "click".

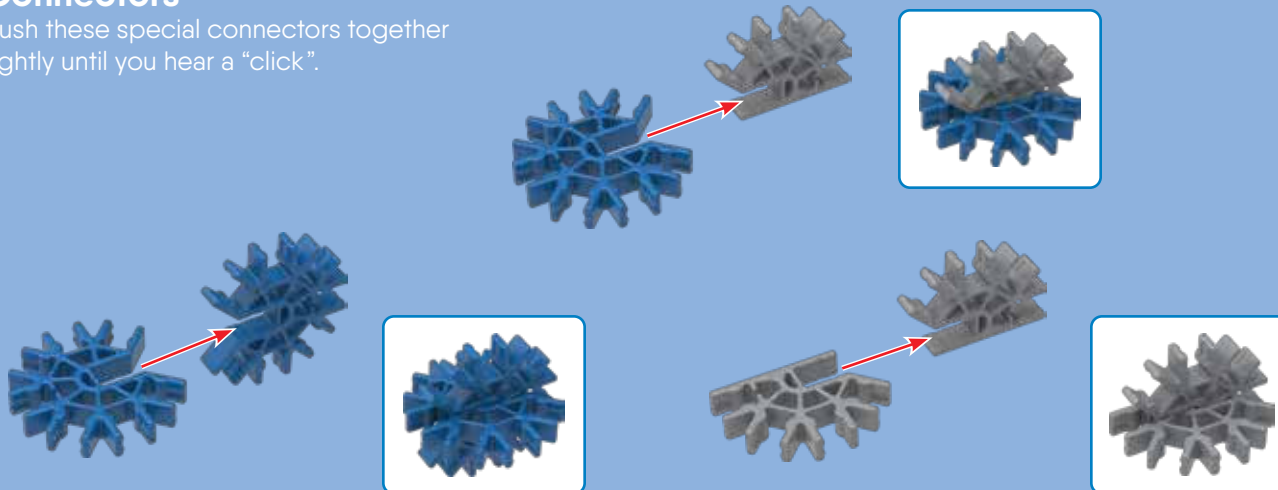

Spacers

Be sure to use the correct color and number of spacers shown.



CONTENTS

- APPLE.....5
- WRENCH6
- BRIDGE6
- COW7
- SCORPION.....8
- TRI-WHEELER9
- CARTWHEELER.....10
- MUDFISH11
- SCOOTER13
- FAN.....15
- TRACTOR16
- ROBOT19
- DRILL.....21
- BUS.....23
- FERRIS WHEEL27
- COMBO HELICOPTER31
- BUILDING IDEAS36



Battery Information

How to Insert and Remove Batteries

Use a small Phillips head screwdriver to loosen the screw. Insert 2 fresh AA (LR6) batteries [not included] into the compartment with the correct polarity (+/-) as shown here.

Install batteries before building models.

CAUTION: To Avoid Battery Leakage

- Insert batteries with correct polarity (+/-) as shown.
- Do not mix different types of batteries.
- Do not mix alkaline, standard (carbon-zinc) or rechargeable (nickel-cadmium) batteries.

- Do not mix new and used batteries. Only batteries of the same or equivalent type recommended should be used.
- Remove exhausted batteries from the toy; do not short circuit supply terminals.
- Remove all batteries if the toy will not be used for a long period of time.

Important Tips

- Alkaline batteries are recommended.
- Rechargeable batteries are not recommended.
- Remove rechargeable batteries before recharging; they must be charged only under adult supervision.
- Non-rechargeable batteries must not be recharged.
- Keep components free of dust; do not immerse or use in water.
- Do not dispose of batteries in a fire; they could leak or explode and cause injury.

WARNING: CHOKING HAZARD

Toy contains a small ball and small parts. Not for children under 3 years.

CAUTION: Keep hands, face, hair and clothing away from all moving parts.

Parts List

Be sure to compare the parts in your set with the parts list here.
If anything is missing, please visit www.Basicfun.com to contact us.
We are here to help you!

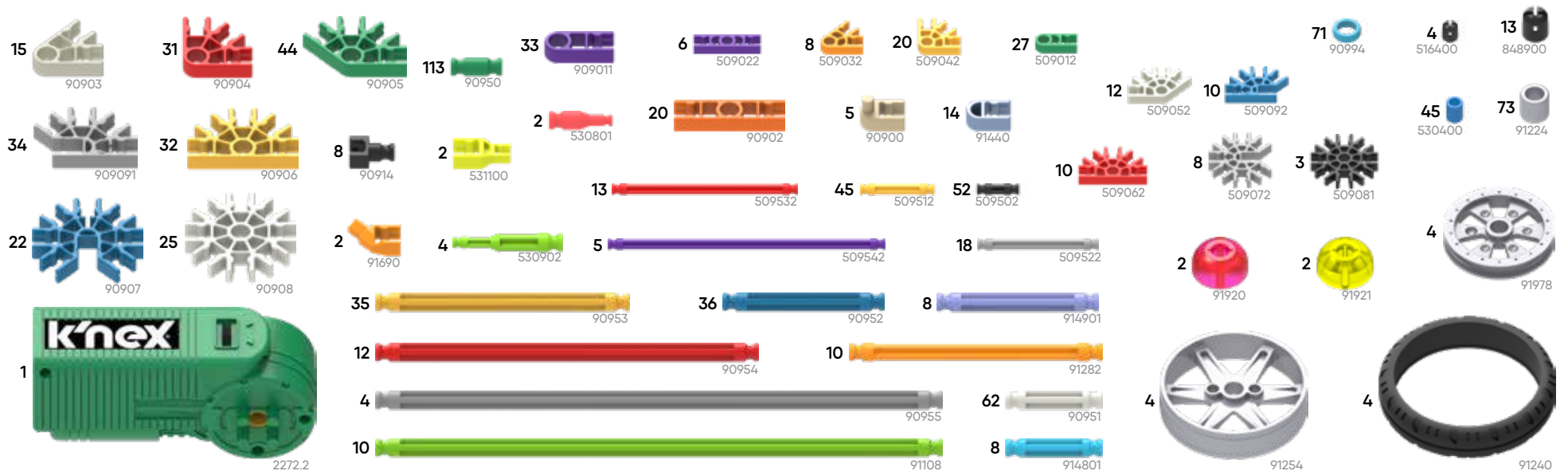

APPLE

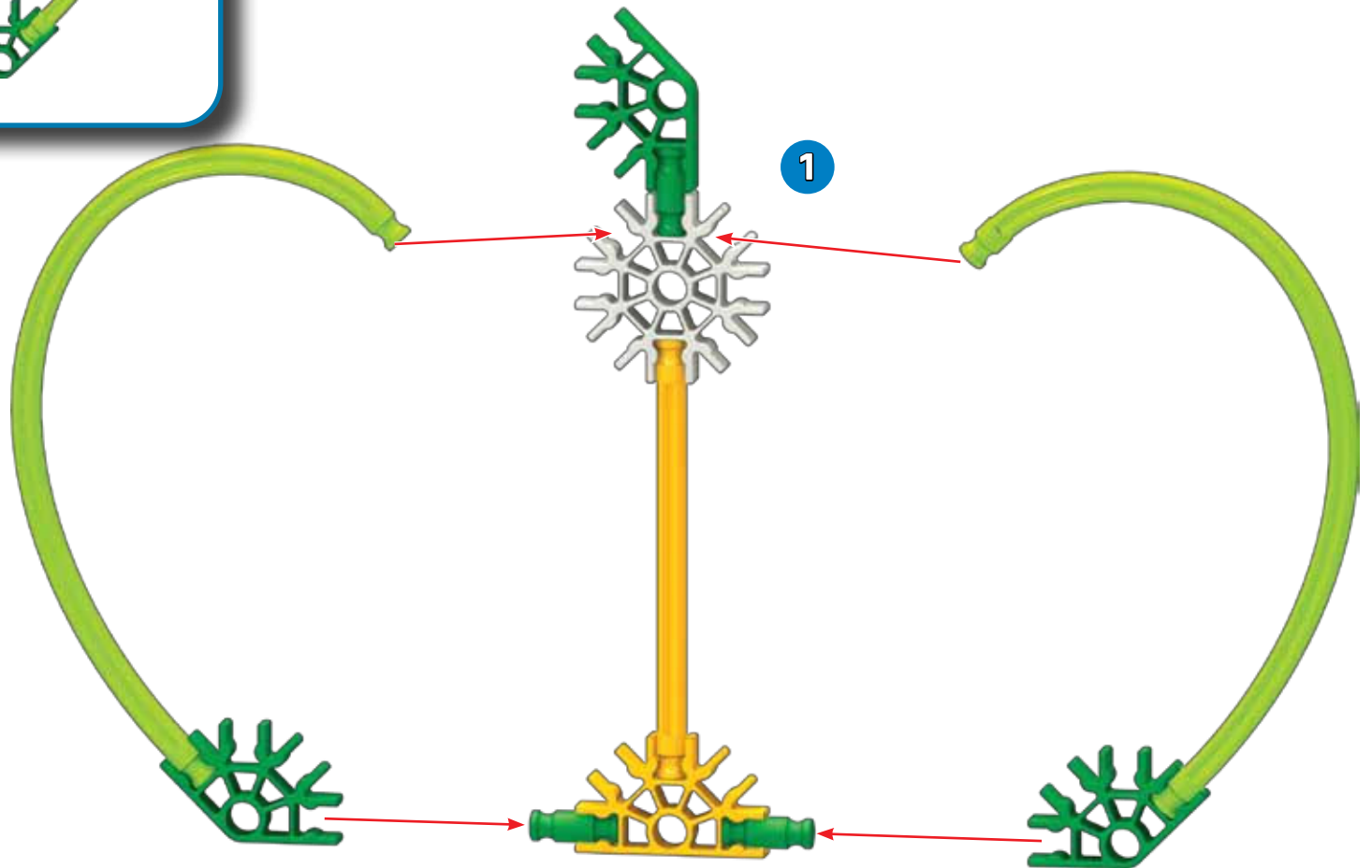
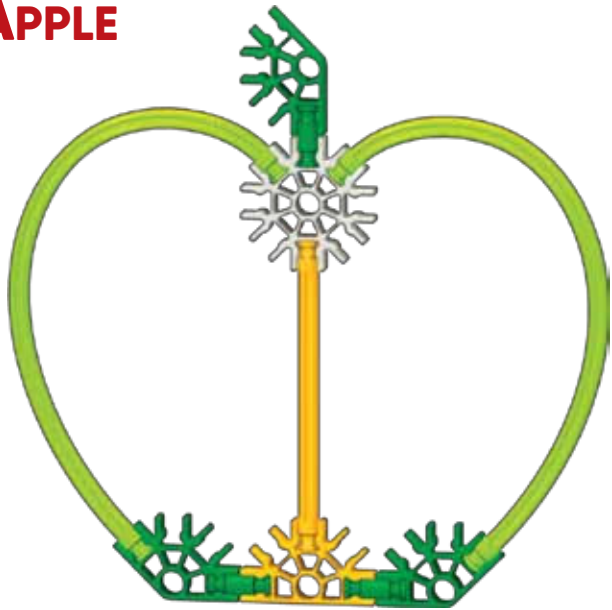

WRENCH

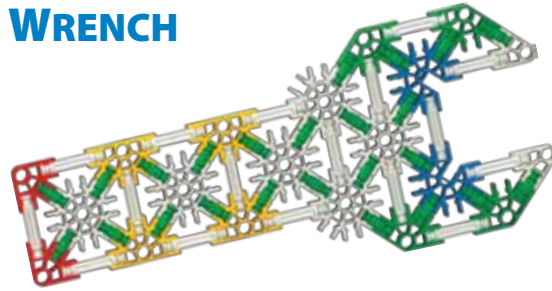

- | | | | | | |
|----|--|----|--|---|--|
| 24 | | 17 | | 2 | |
| 2 | | 2 | | 2 | |
| 4 | | 4 | | 6 | |

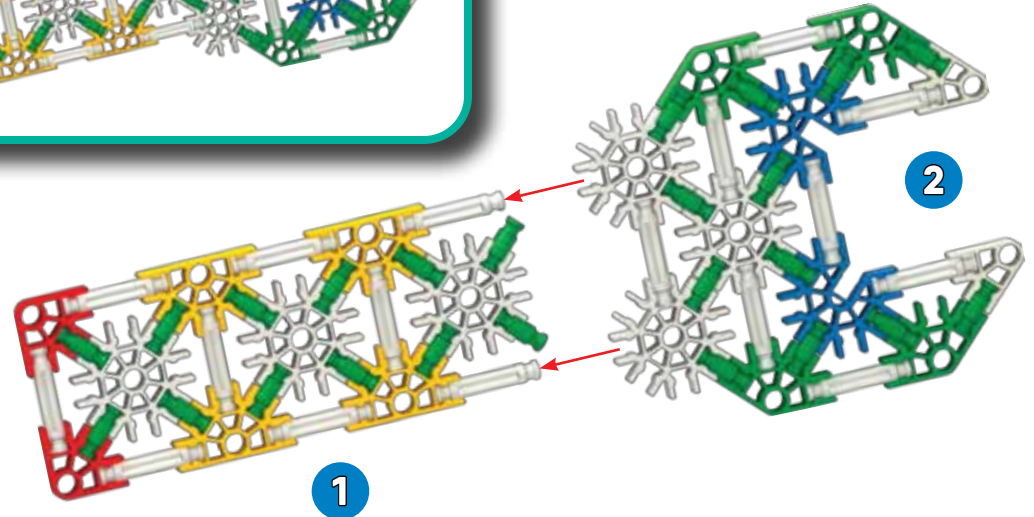

BRIDGE

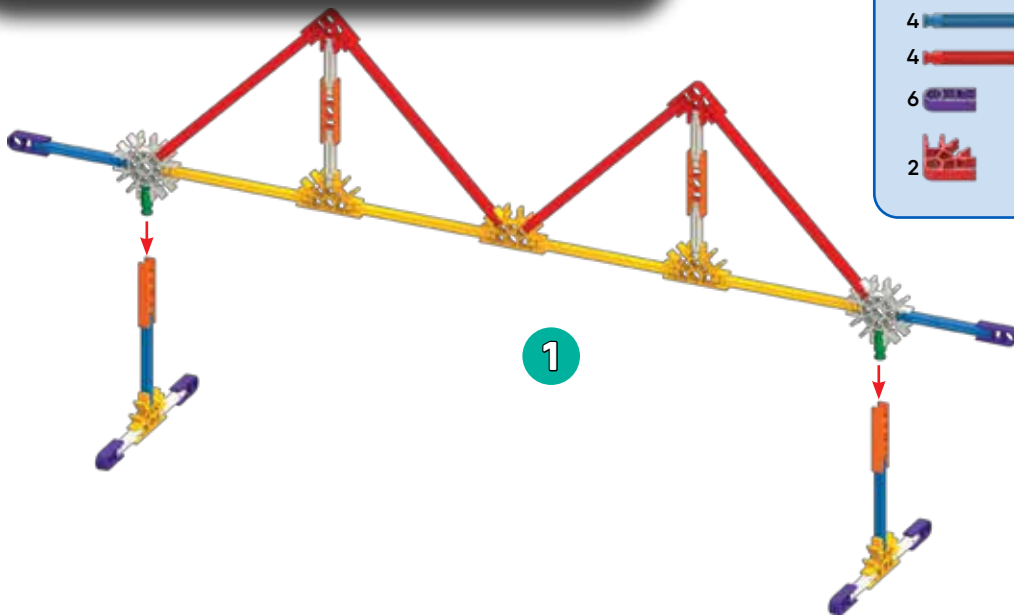

- | | | | |
|---|--|---|--|
| 2 | | 8 | |
| 4 | | 4 | |
| 4 | | | |
| 6 | | 4 | |
| 2 | | 5 | |
| | | 2 | |

Cow

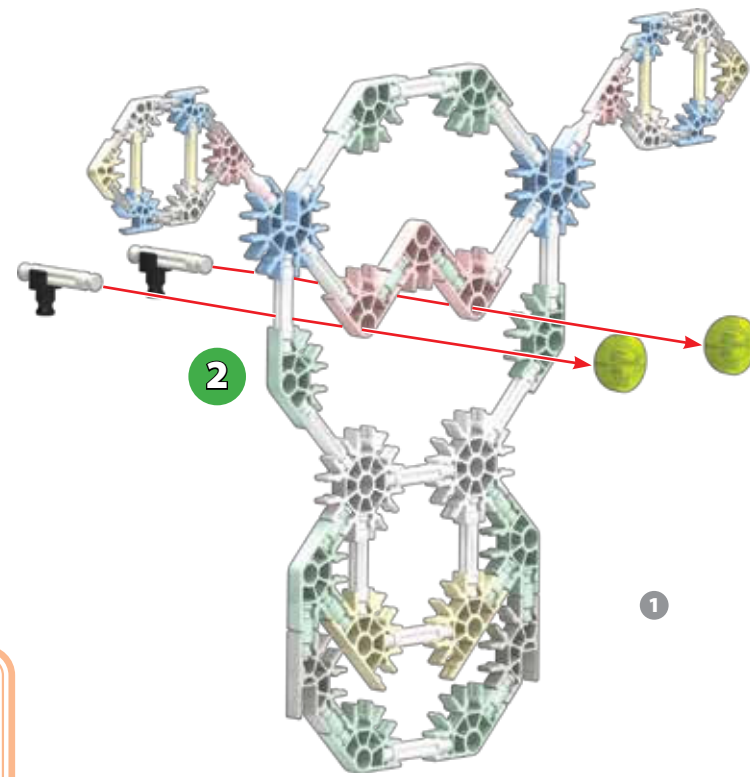

- 2
- 2
- 2

1

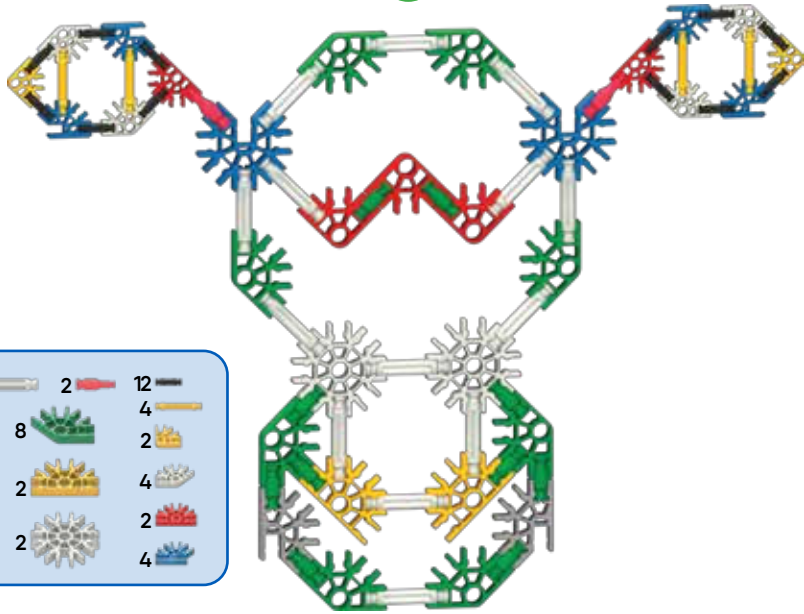

- | | | | |
|----|----|---|----|
| 10 | 14 | 2 | 12 |
| 3 | 8 | 4 | 4 |
| 2 | 2 | 4 | 2 |
| 2 | 2 | 2 | 4 |

SCORPION

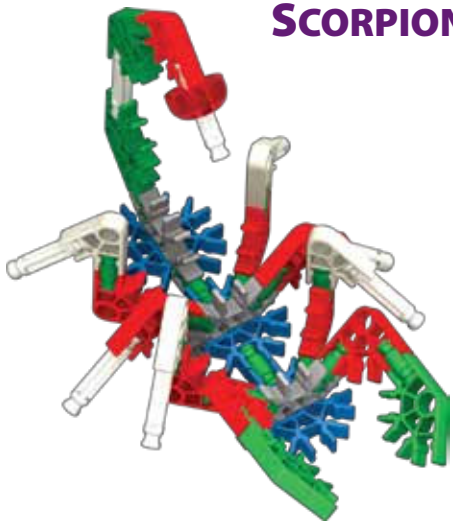

2

- | | | |
|----|---|---|
| 12 | 6 | 1 |
| 4 | 5 | 2 |
| 1 | 2 | |

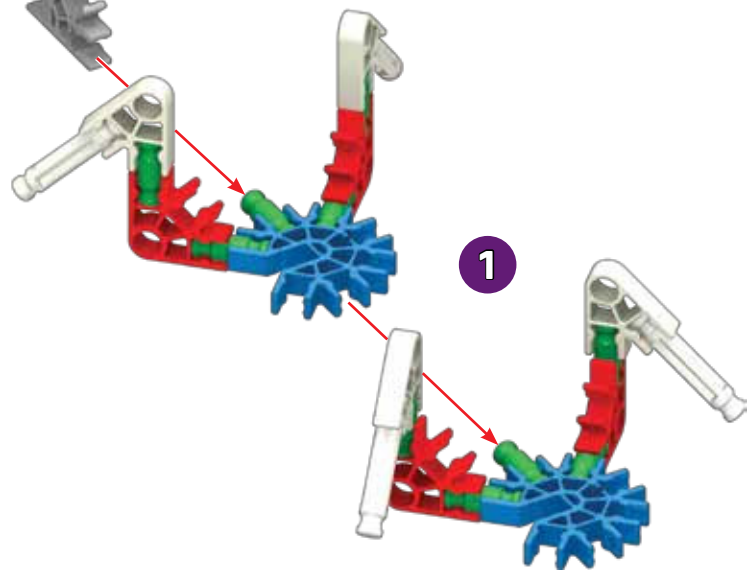

1

- | | |
|---|---|
| 6 | 2 |
| 4 | 2 |
| 2 | 1 |

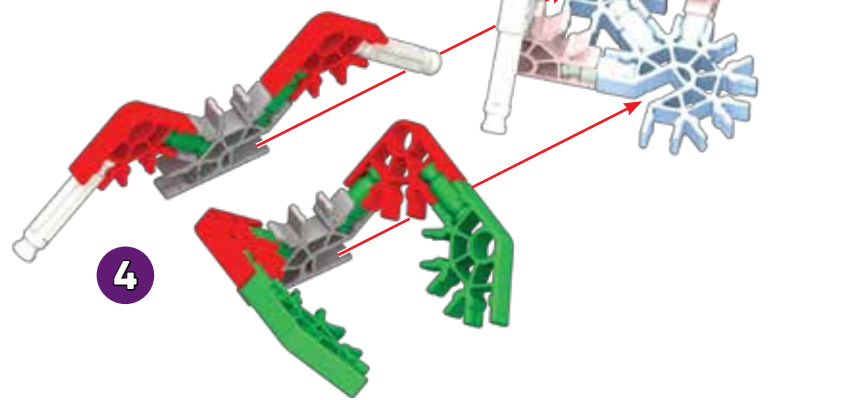

4

3

1-2

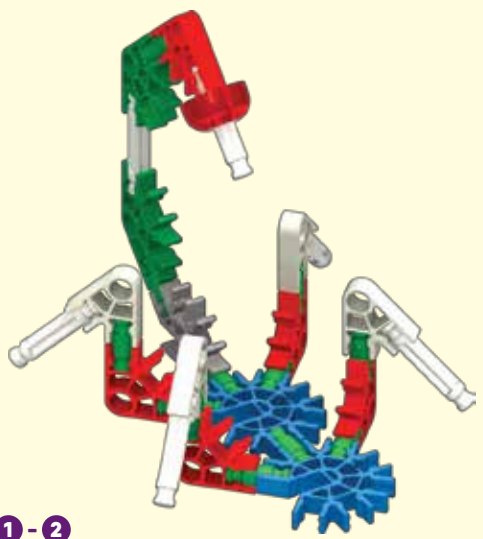

1-2

TRI-WHEELER

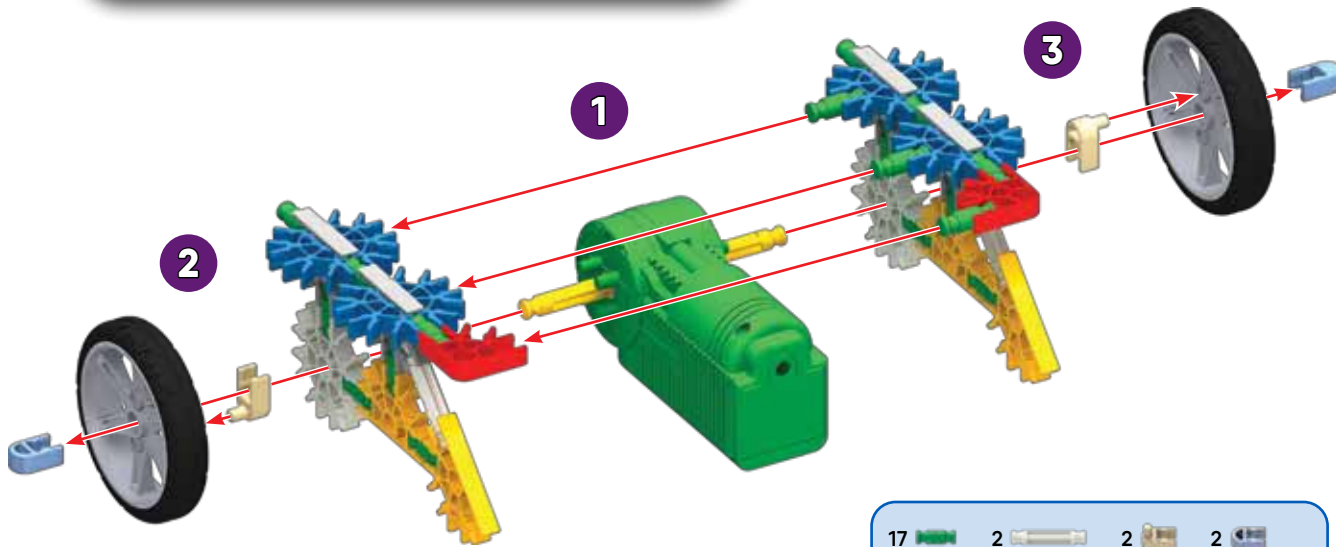
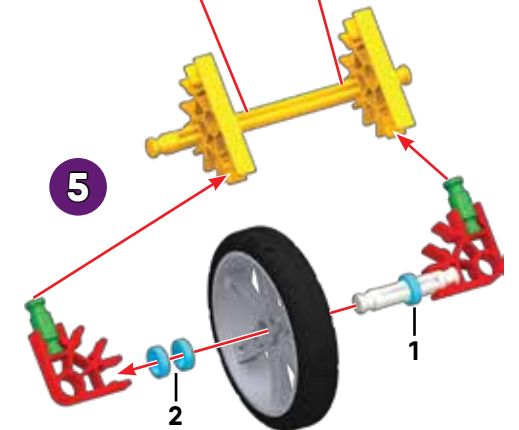
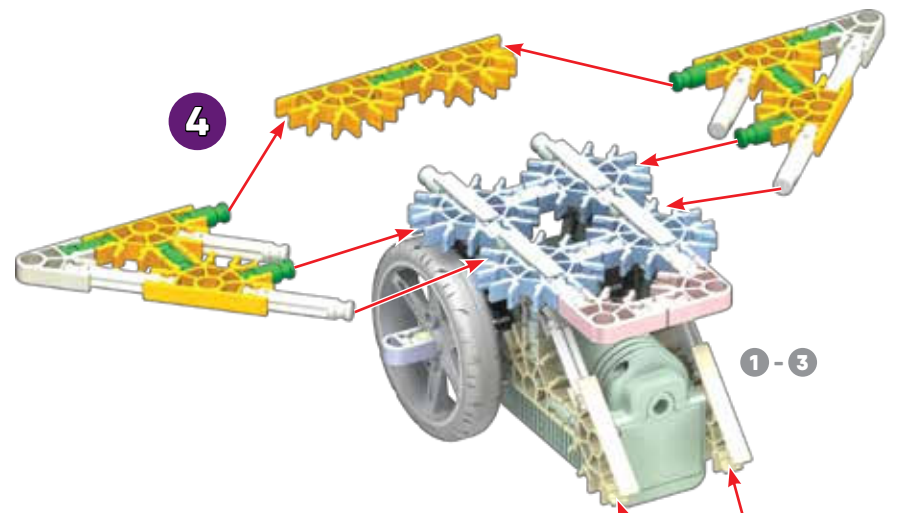

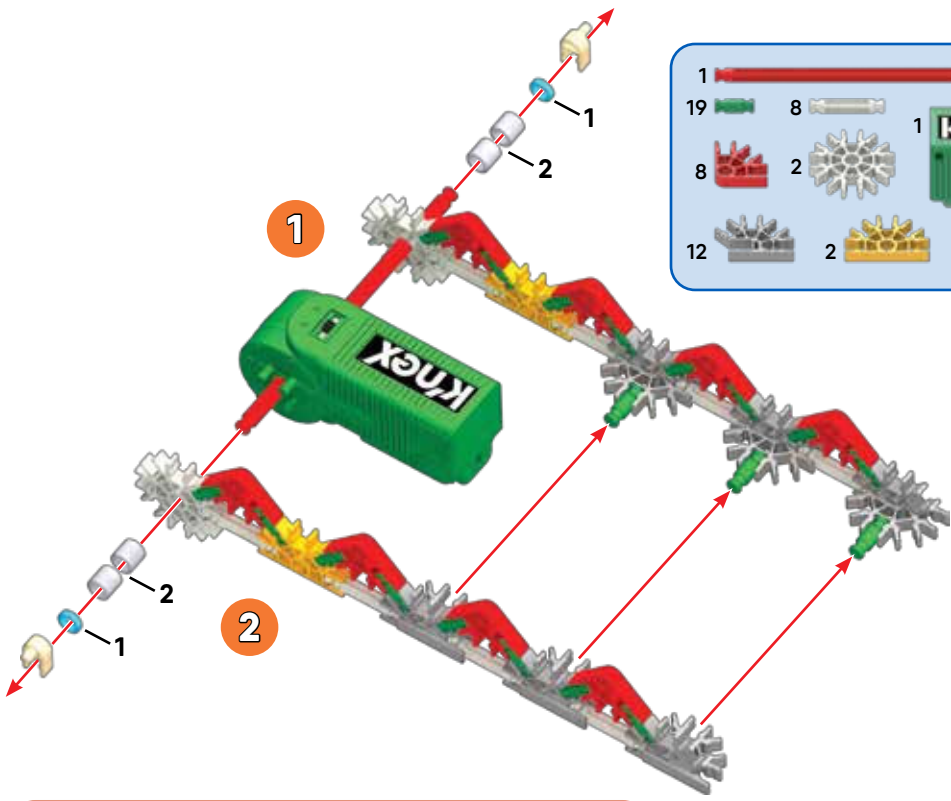

- | | | | | | |
|----|--|---|--|---|--|
| 1 | | 2 | | 4 | |
| 19 | | 8 | | 1 | |
| 8 | | 2 | | | |
| 12 | | 2 | | 2 | |

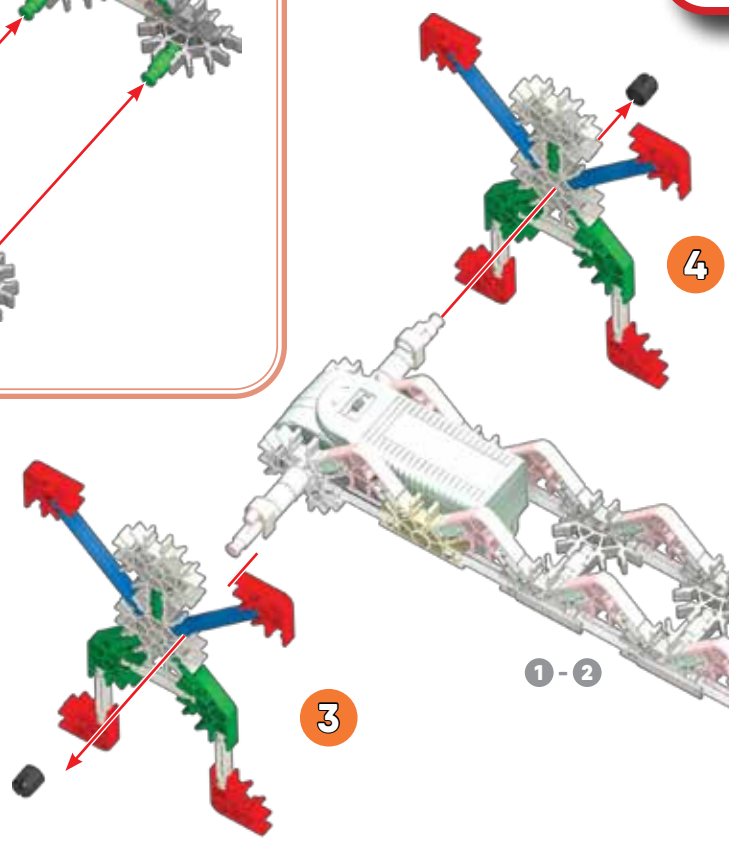
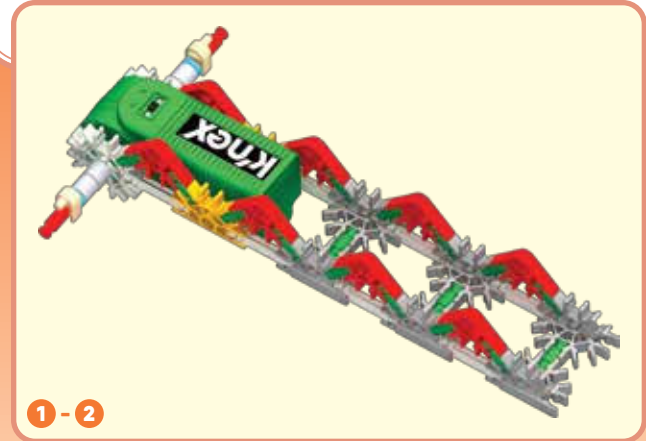

- | | | | | | | | |
|----|--|---|--|---|--|---|--|
| 10 | | 8 | | 4 | | 2 | |
| 4 | | 1 | | | | | |
| 10 | | 4 | | 6 | | | |
| 2 | | | | 2 | | | |

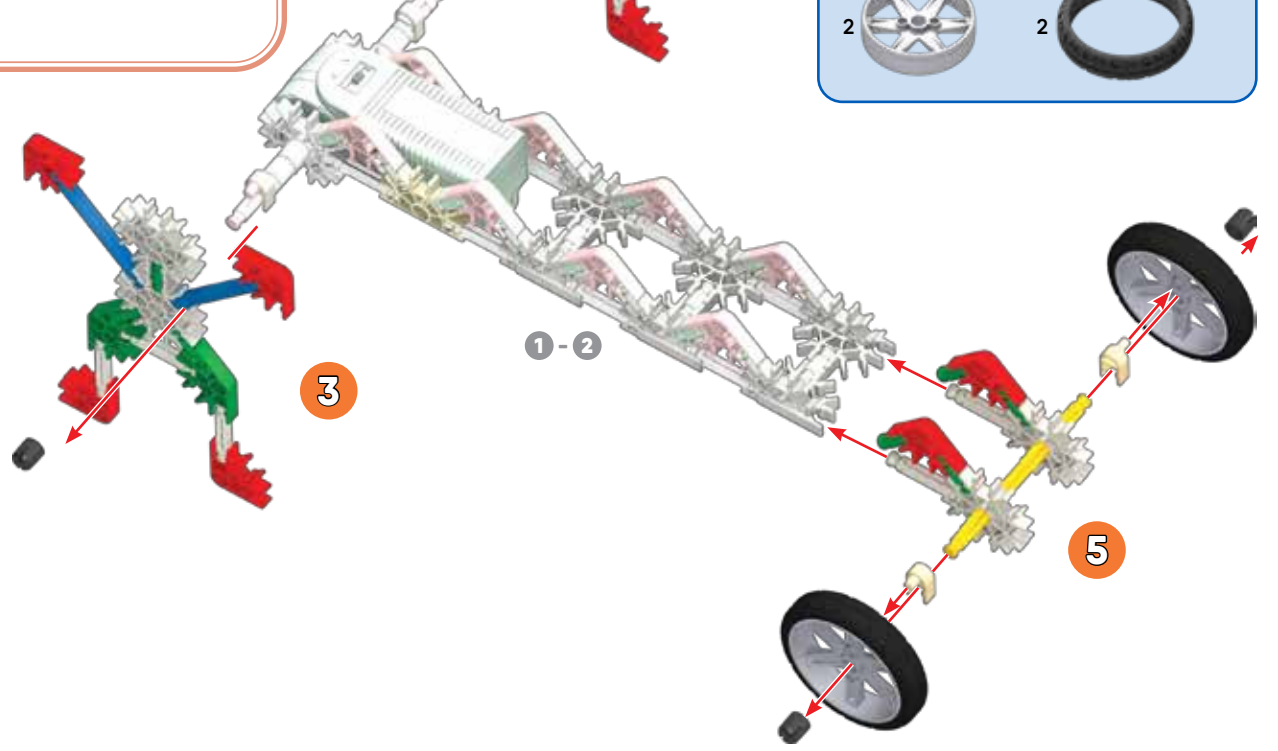

- | | | | | | | | |
|---|--|--|--|---|--|--|--|
| 2 | | | | 2 | | | |
|---|--|--|--|---|--|--|--|

MUDFISH

x2

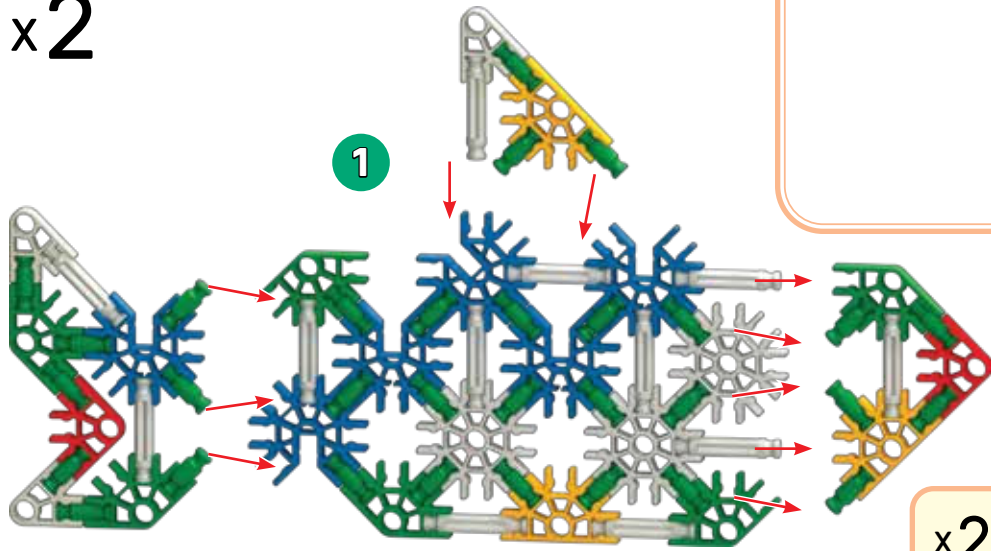

62	24	6
6	4	6
12	6	12

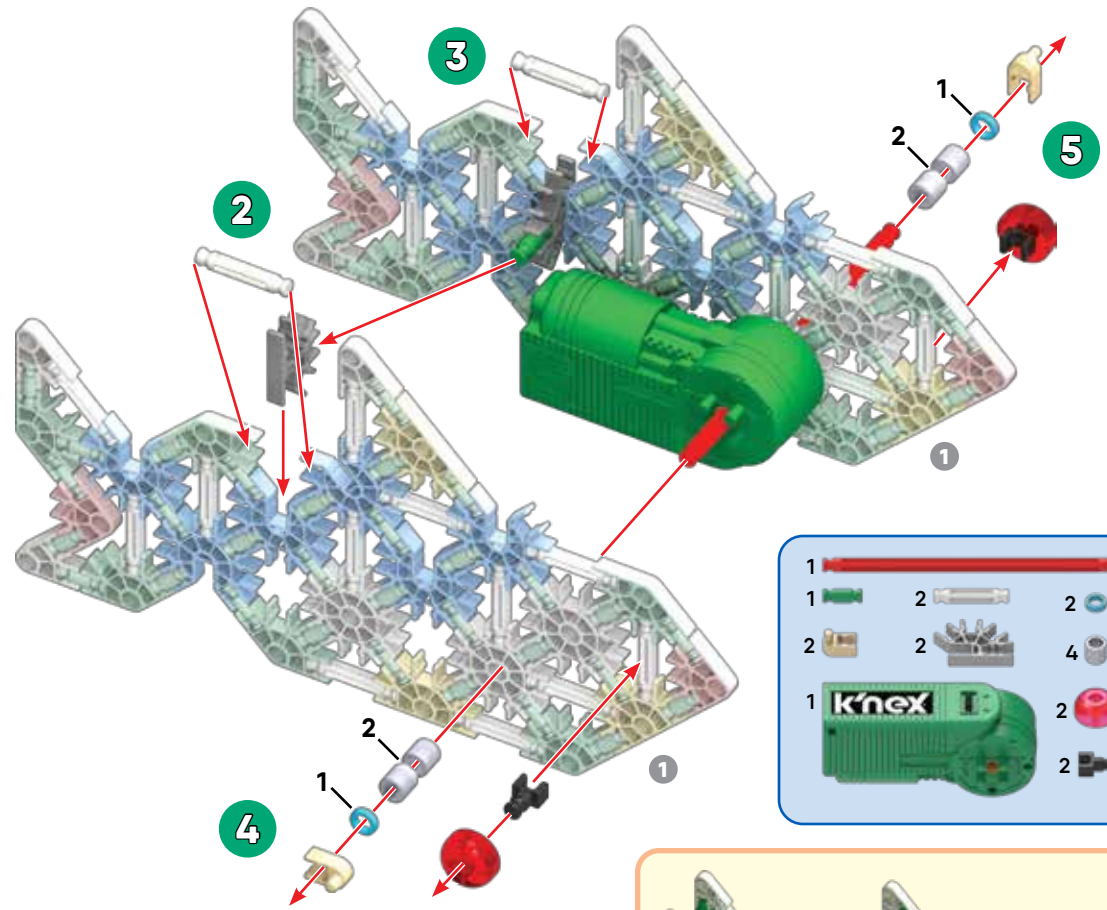

1	2	2
1	2	4
1	2	2

1 K'nex motor

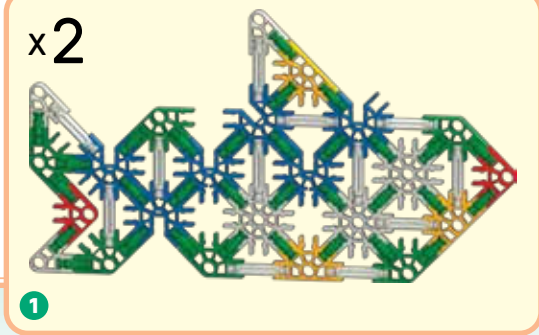
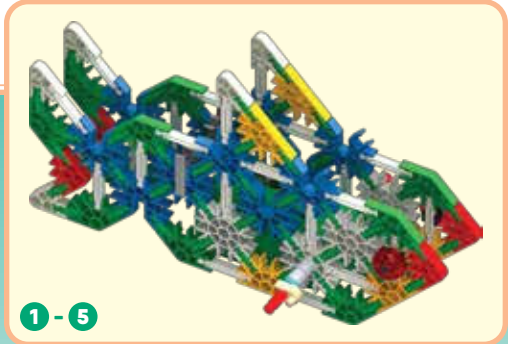

x2

- 16
- 16
- 4
- 12
- 2

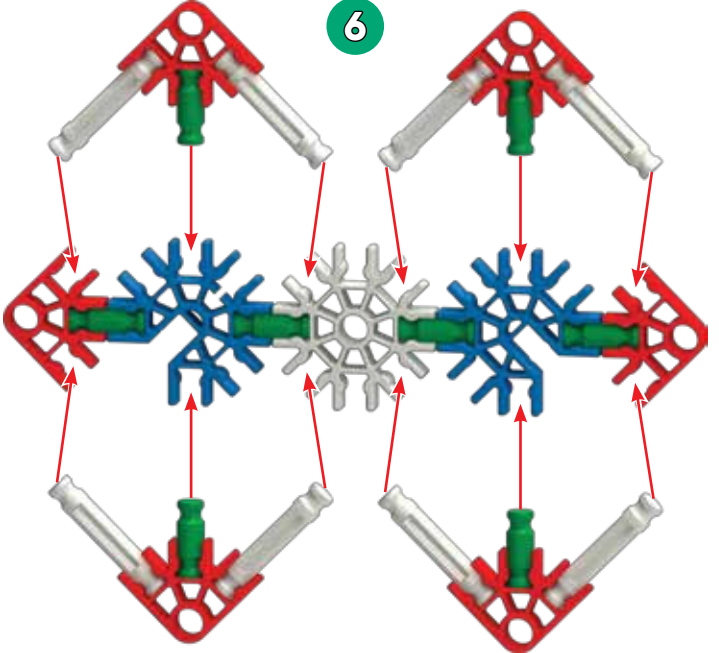

x2

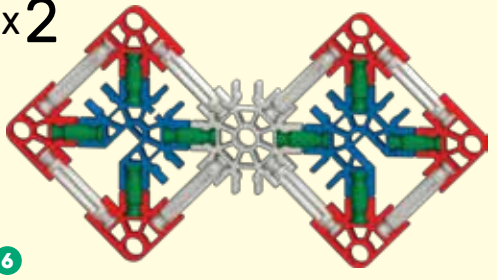

MUDFISH

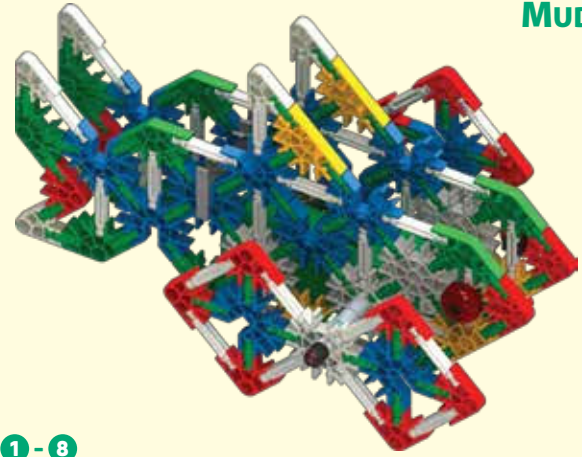

1-8

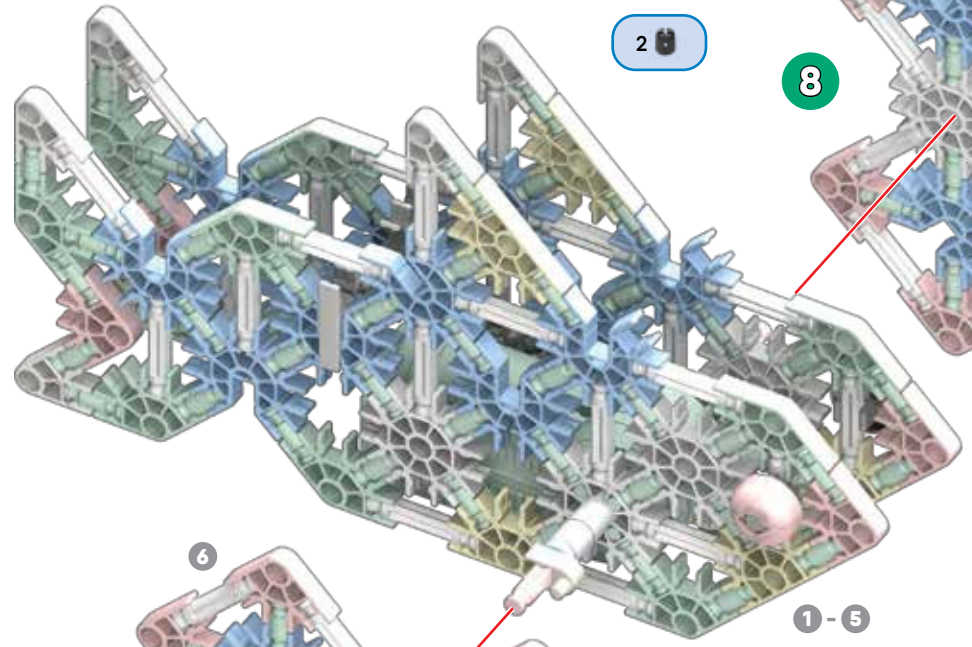

8

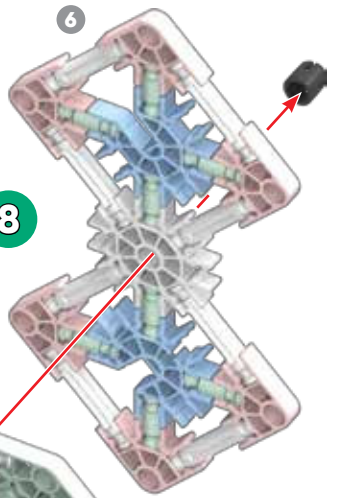

7

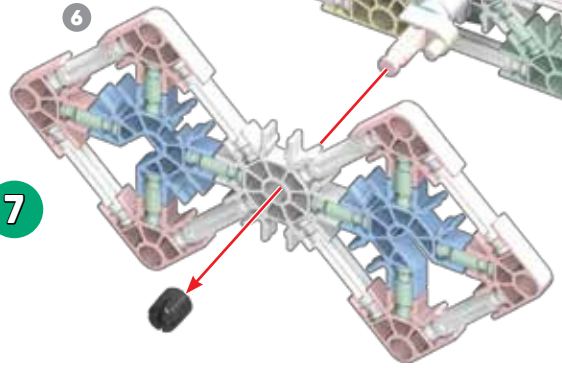

1-5

SCOOTER

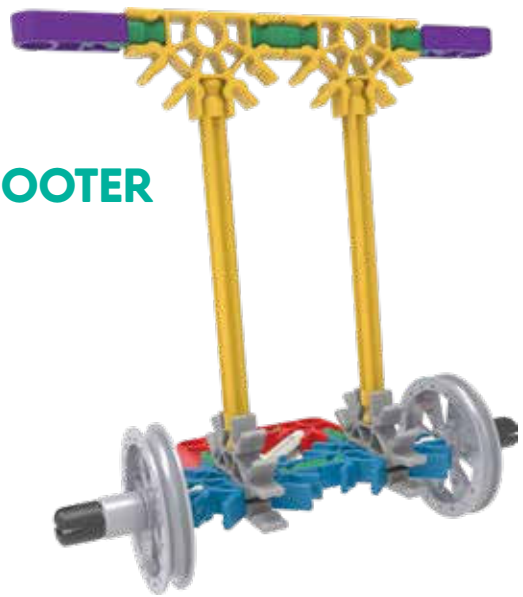

- | | | | |
|---|--|---|--|
| 3 | | 2 | |
| 2 | | | |
| 2 | | 2 | |

2

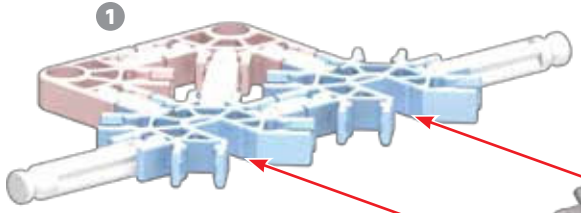

1

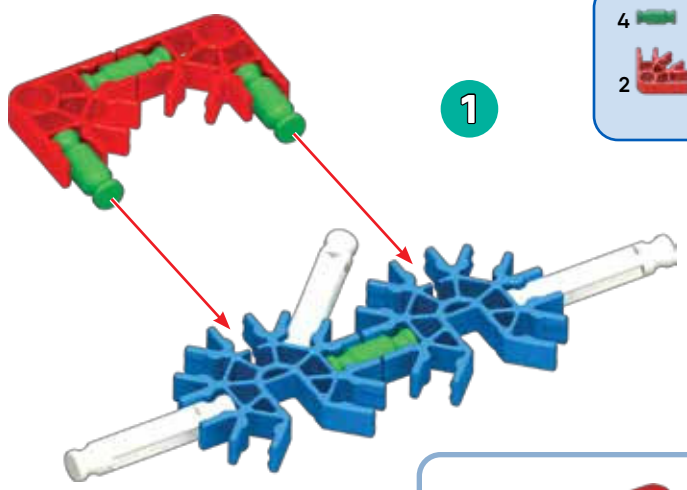
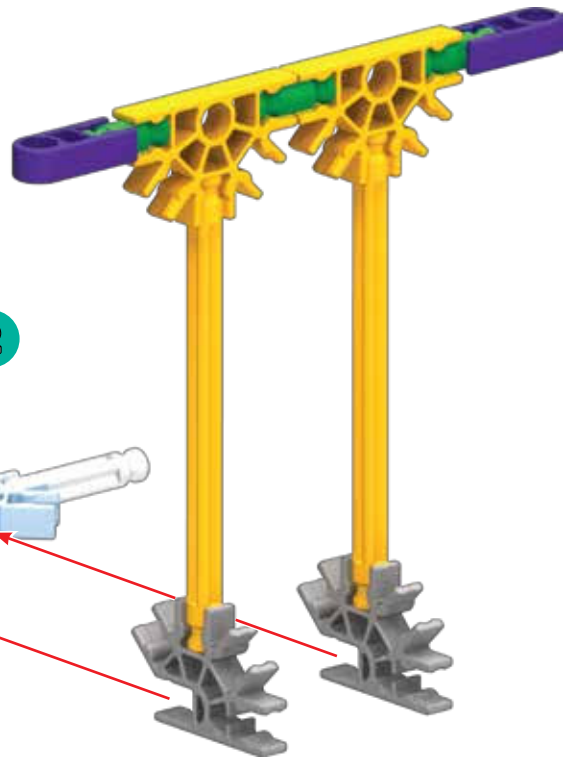

1

- | | | | |
|---|--|---|--|
| 4 | | 3 | |
| 2 | | 2 | |

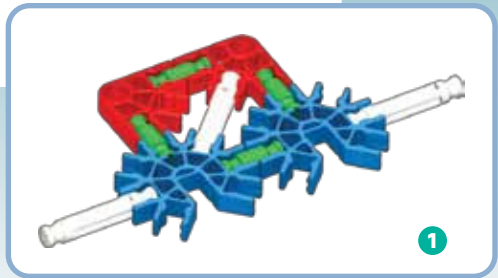

1



1-2

SCOOTER



1 - 3

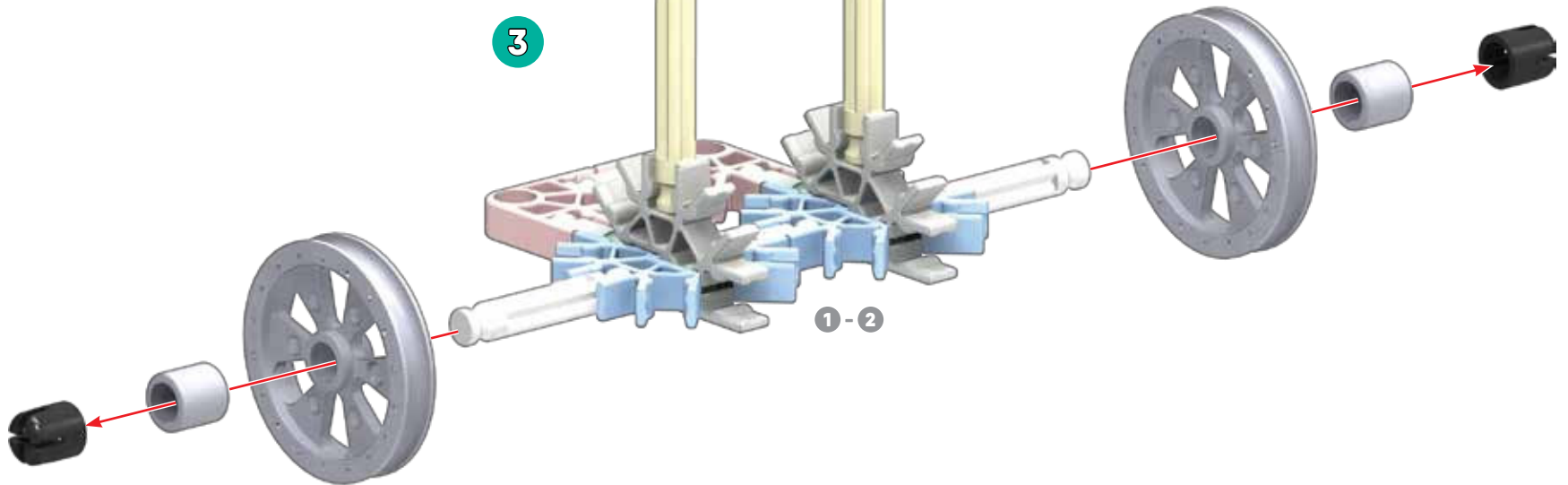
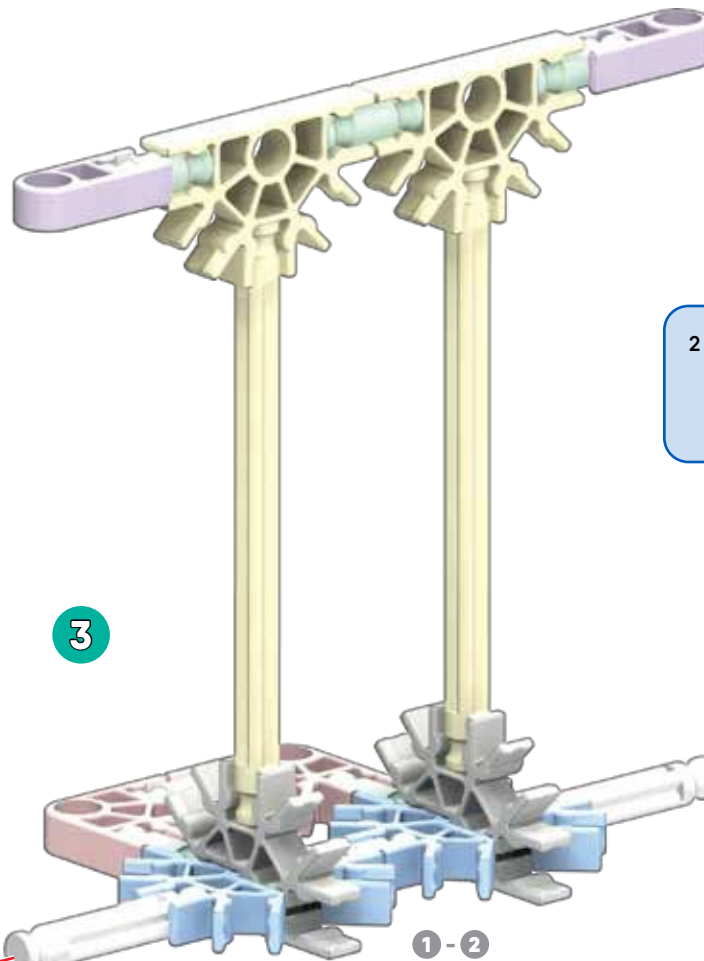

1 - 2

FAN



- | | |
|----|-------|
| 1 | 2 |
| 10 | 3 |
| 1 | 1 |
| 1 | 2 |
| 8 | 1 |
| 1 | K'nex |

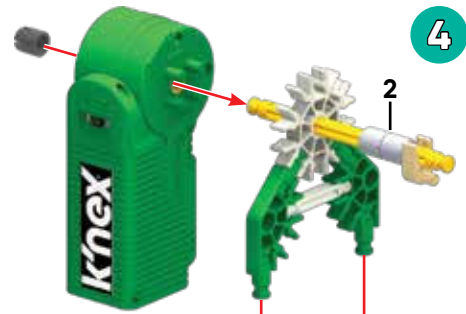

4

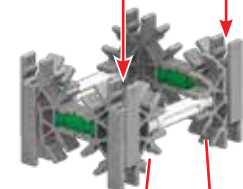

3

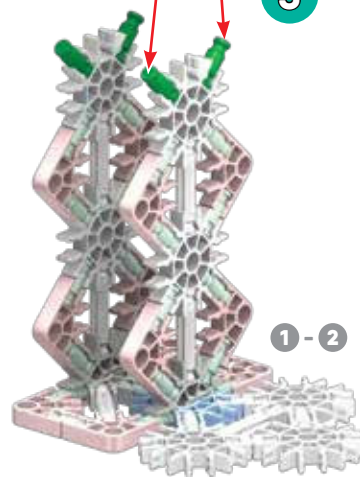

1-2

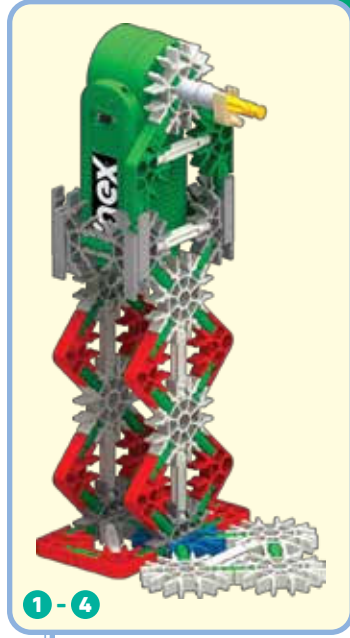

1-4

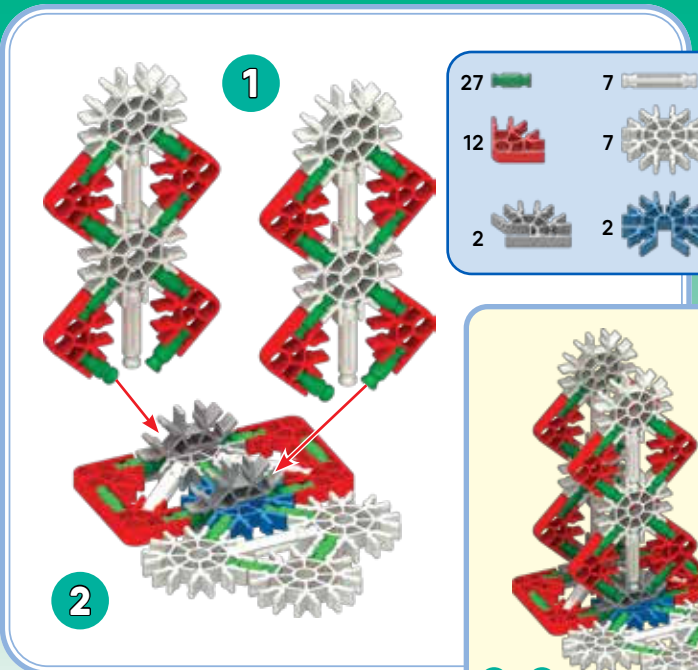

1

- | | |
|----|---|
| 27 | 7 |
| 12 | 7 |
| 2 | 2 |

2

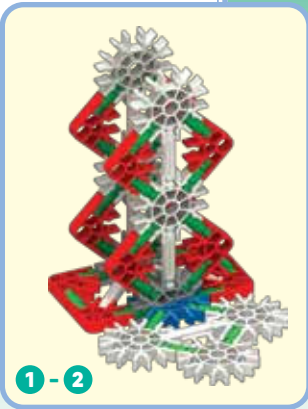

1-2

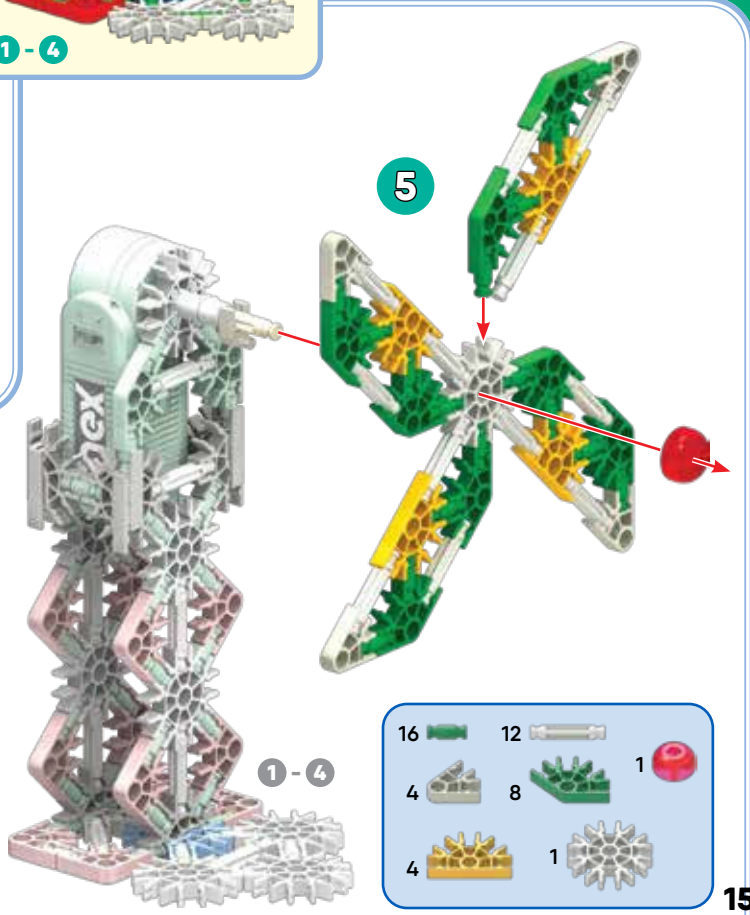

5

- | | | |
|----|----|---|
| 16 | 12 | 1 |
| 4 | 8 | 1 |
| 4 | 1 | 1 |

1-4

TRACTOR

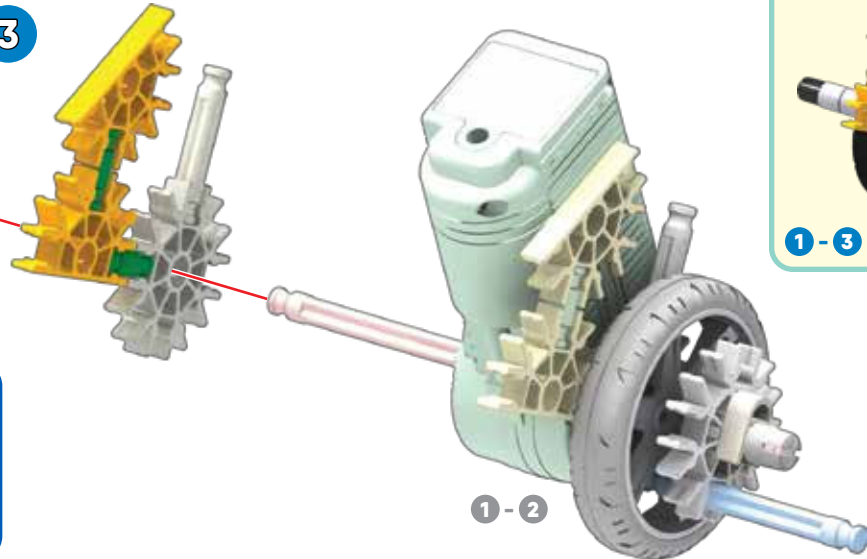
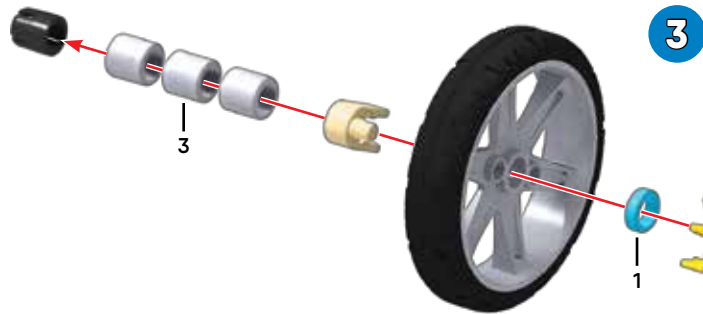
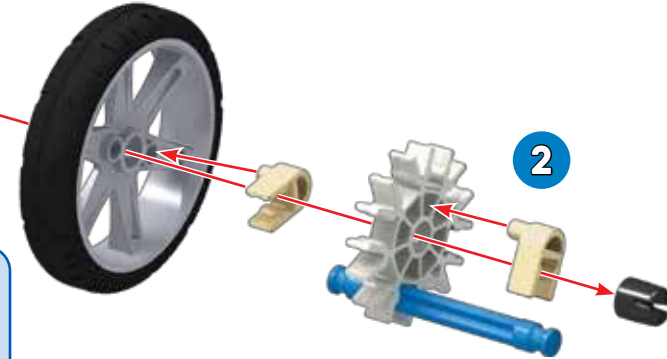
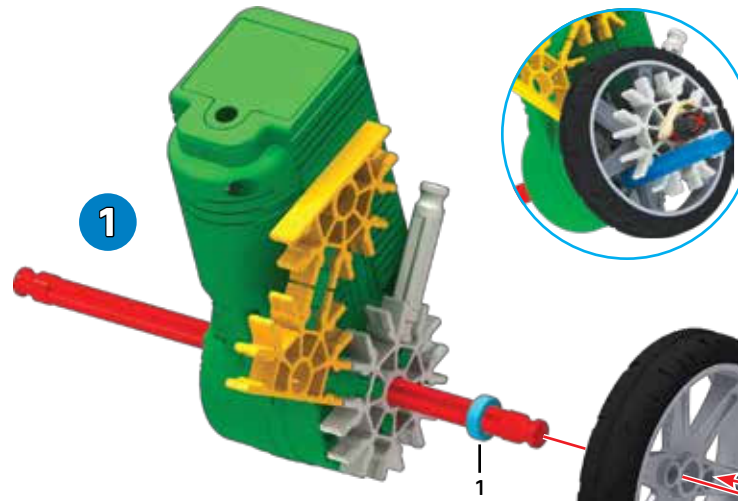

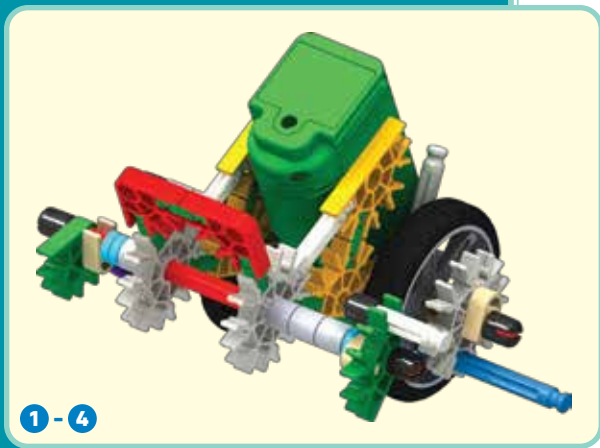

- | | | | | | | | |
|---|--|---|--|---|--|---|--|
| 1 | | 3 | | 3 | | 3 | |
| 6 | | 1 | | 4 | | 2 | |
| 2 | | 1 | | 2 | | 2 | |
| 2 | | 2 | | | | | |

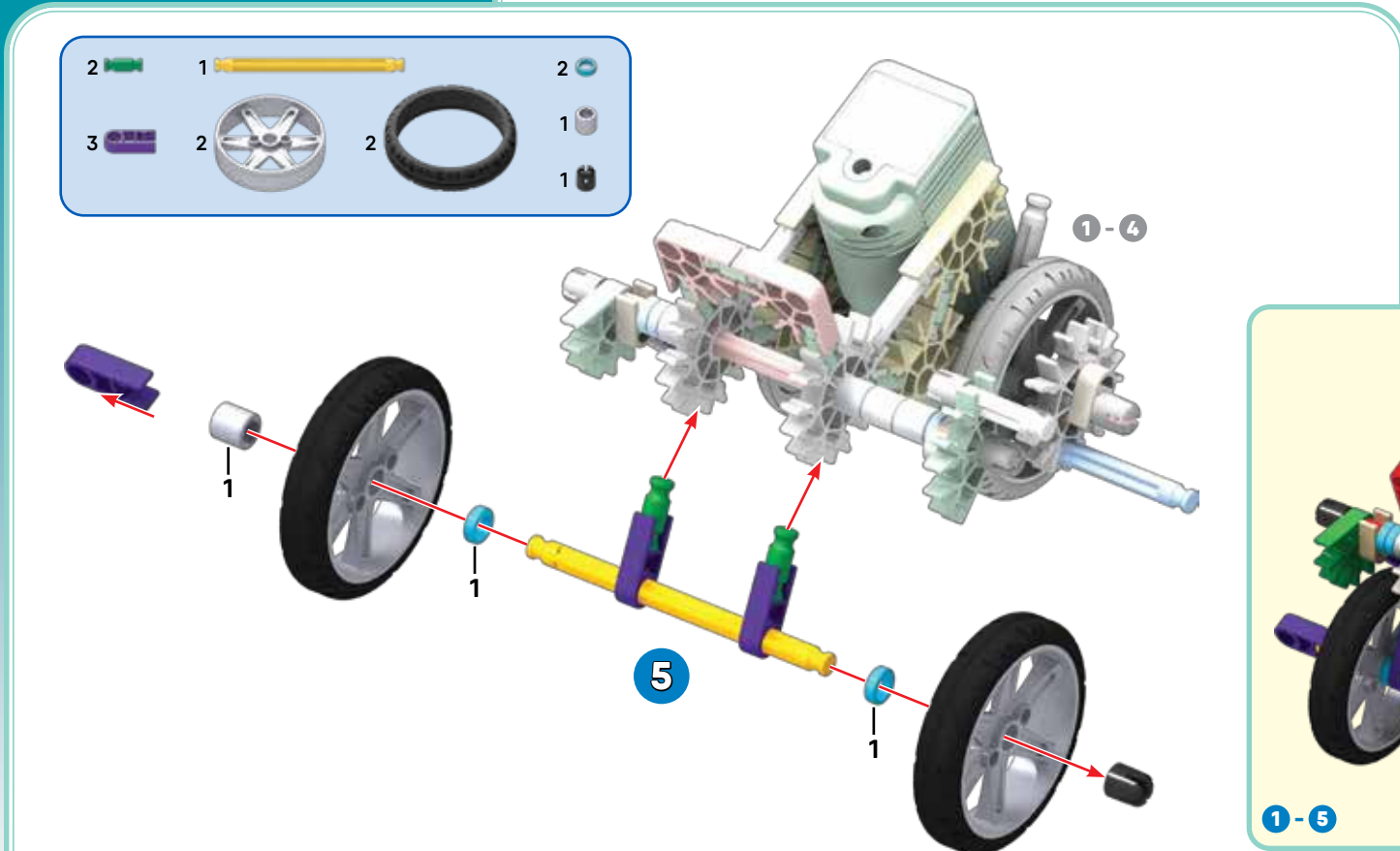
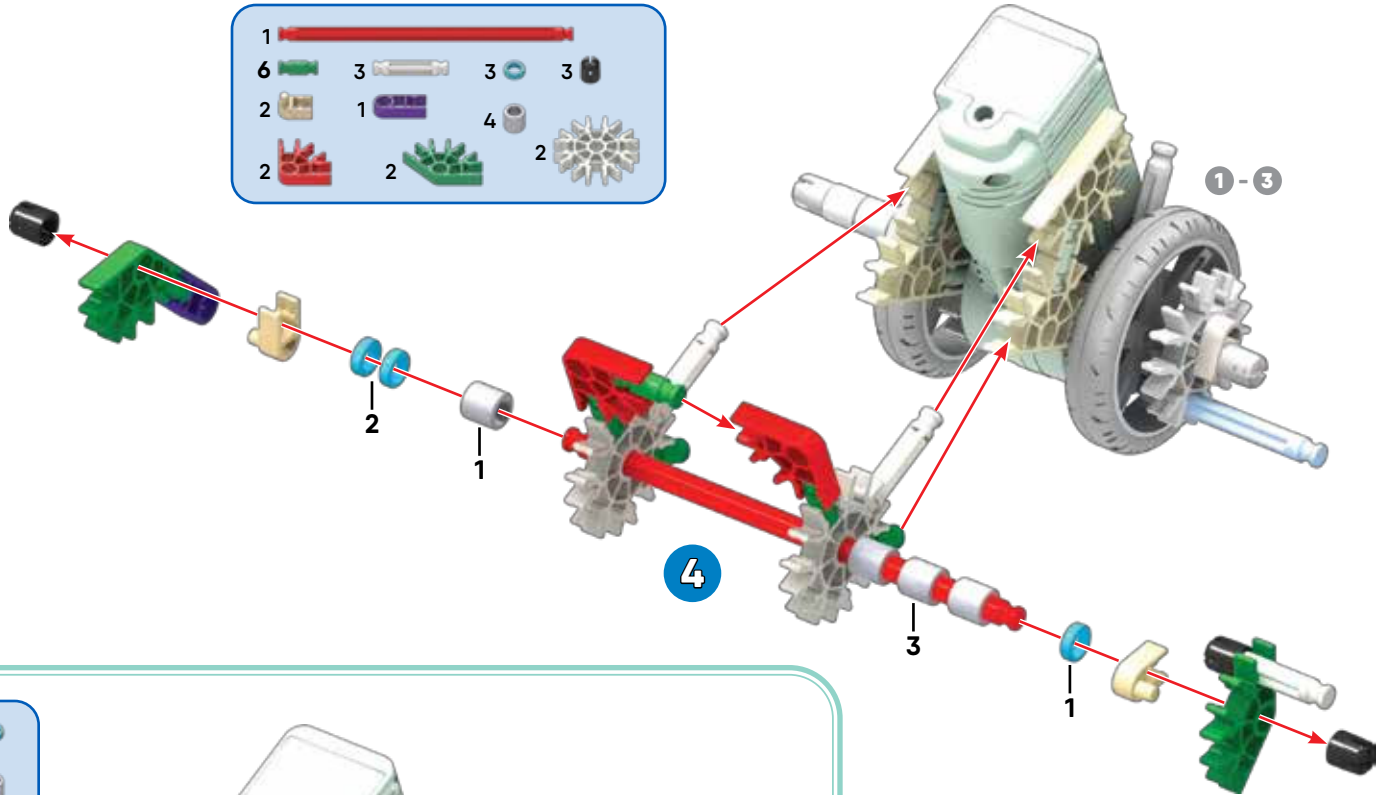

- | | | | | | |
|---|--|---|--|---|--|
| 2 | | 1 | | 2 | |
| 3 | | 2 | | 1 | |
| | | 2 | | 1 | |

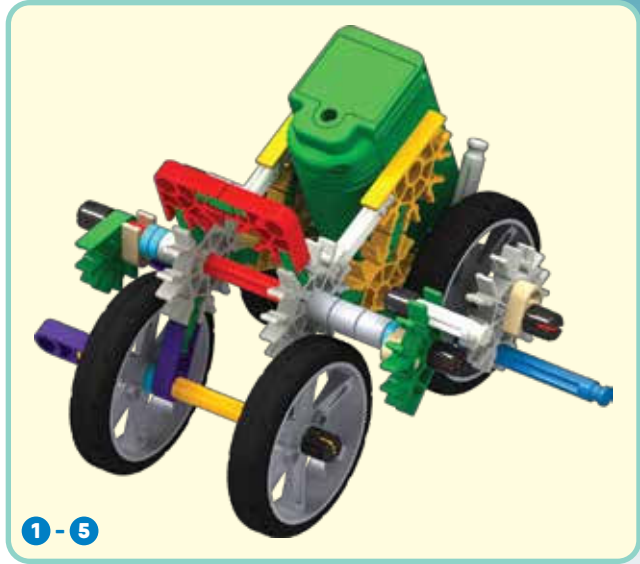

- 4
- 2
- 2
- 2
- 1
- 3
- 2
- 8
- 2
- 2
- 2
- 8

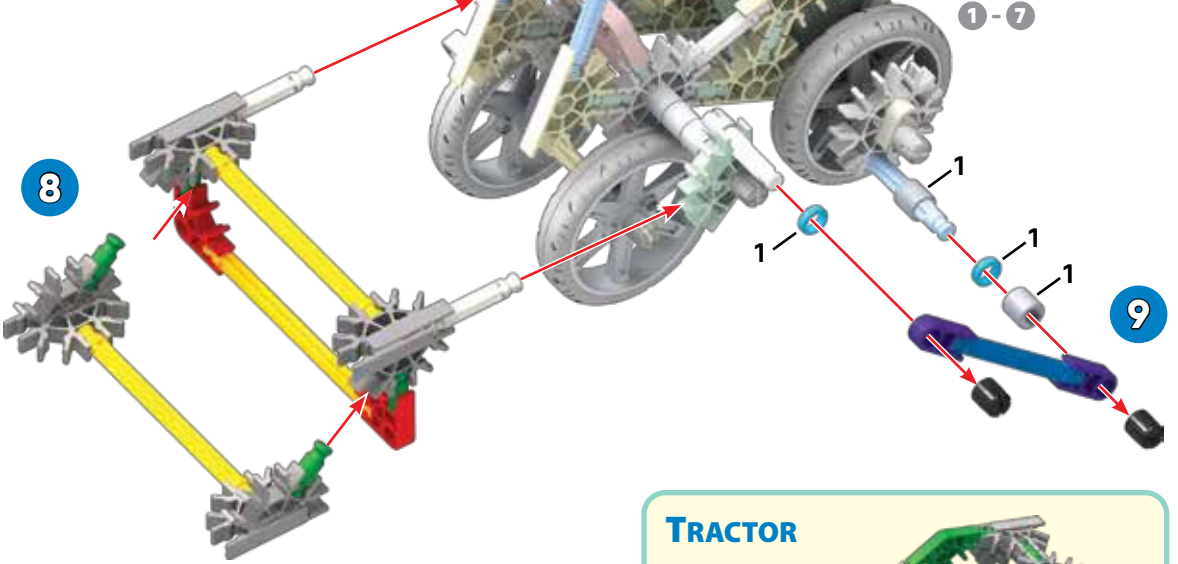
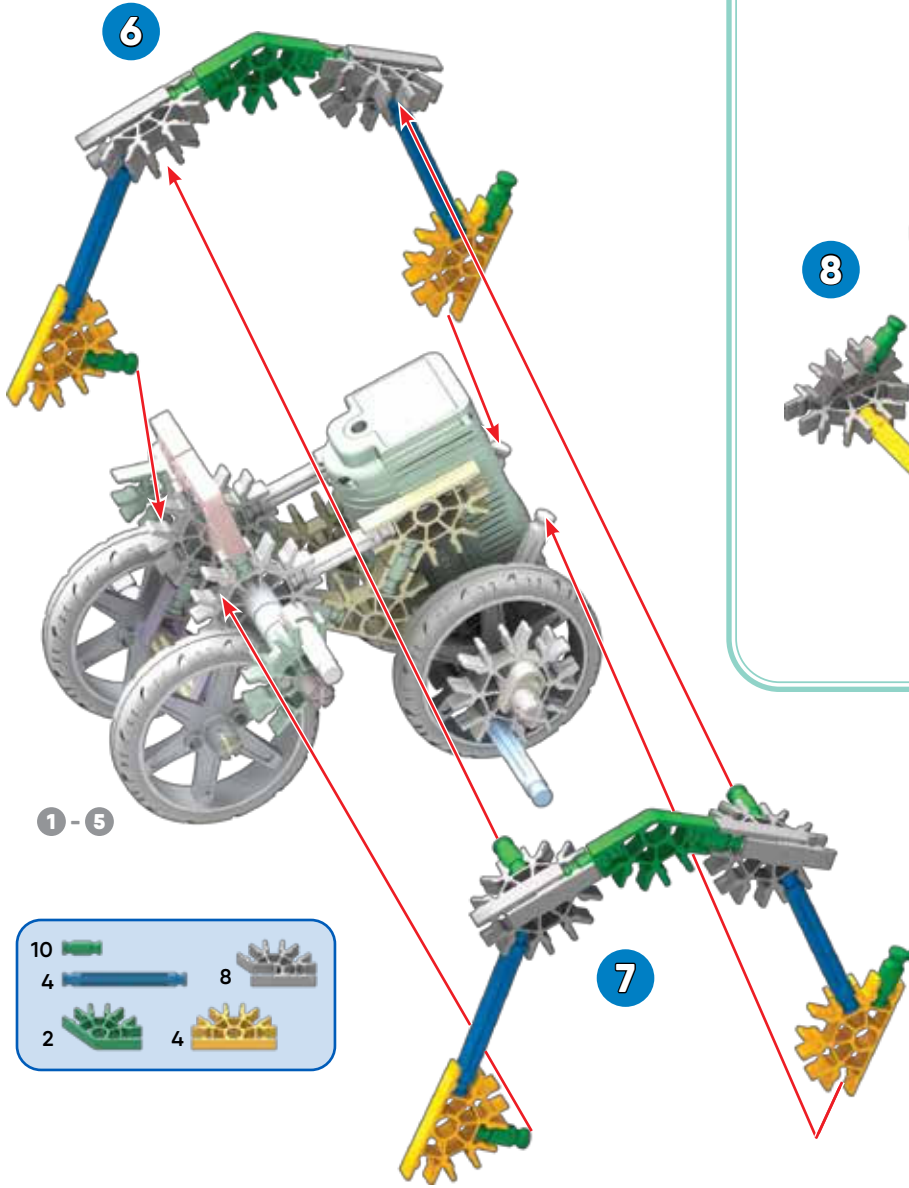

- 10
- 4
- 2
- 8
- 4

TRACTOR

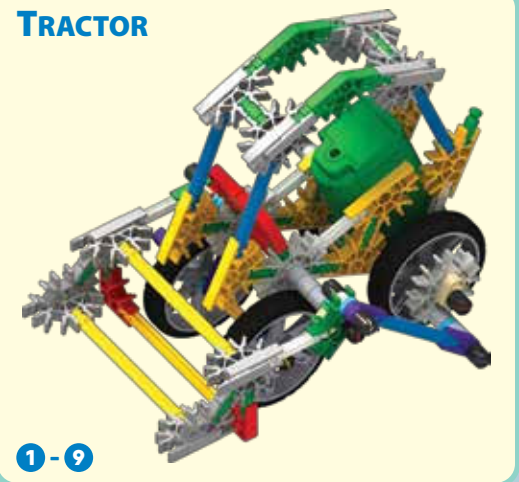

ROBOT

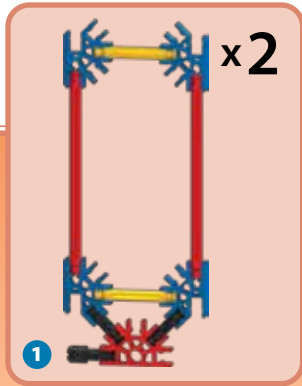
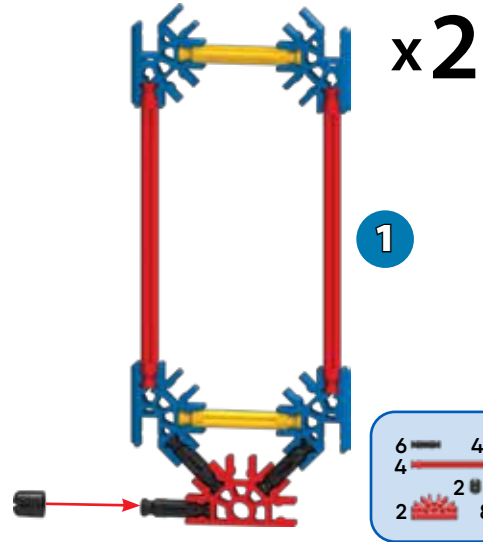

2

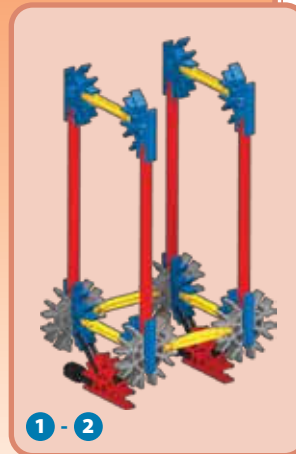
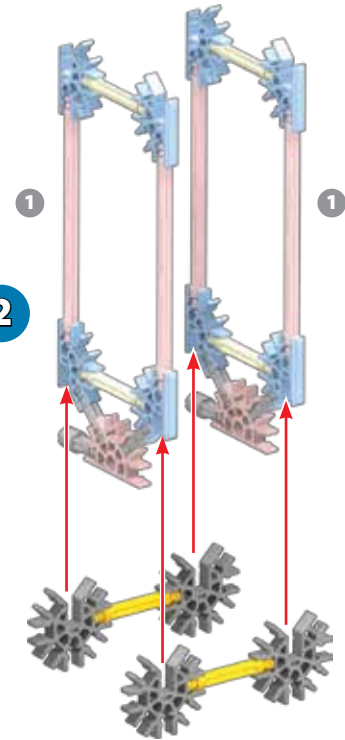

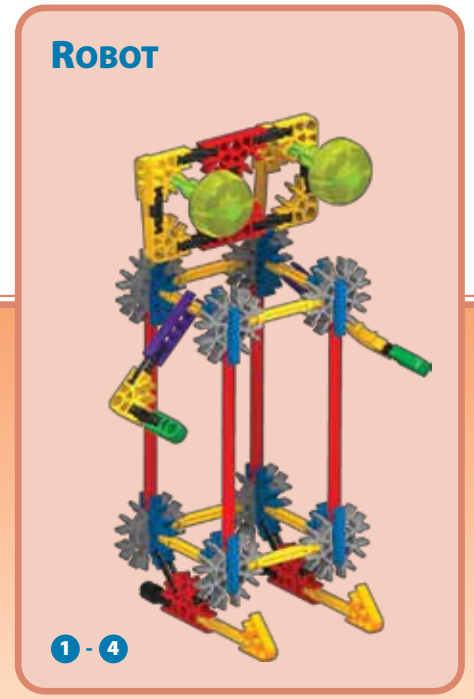
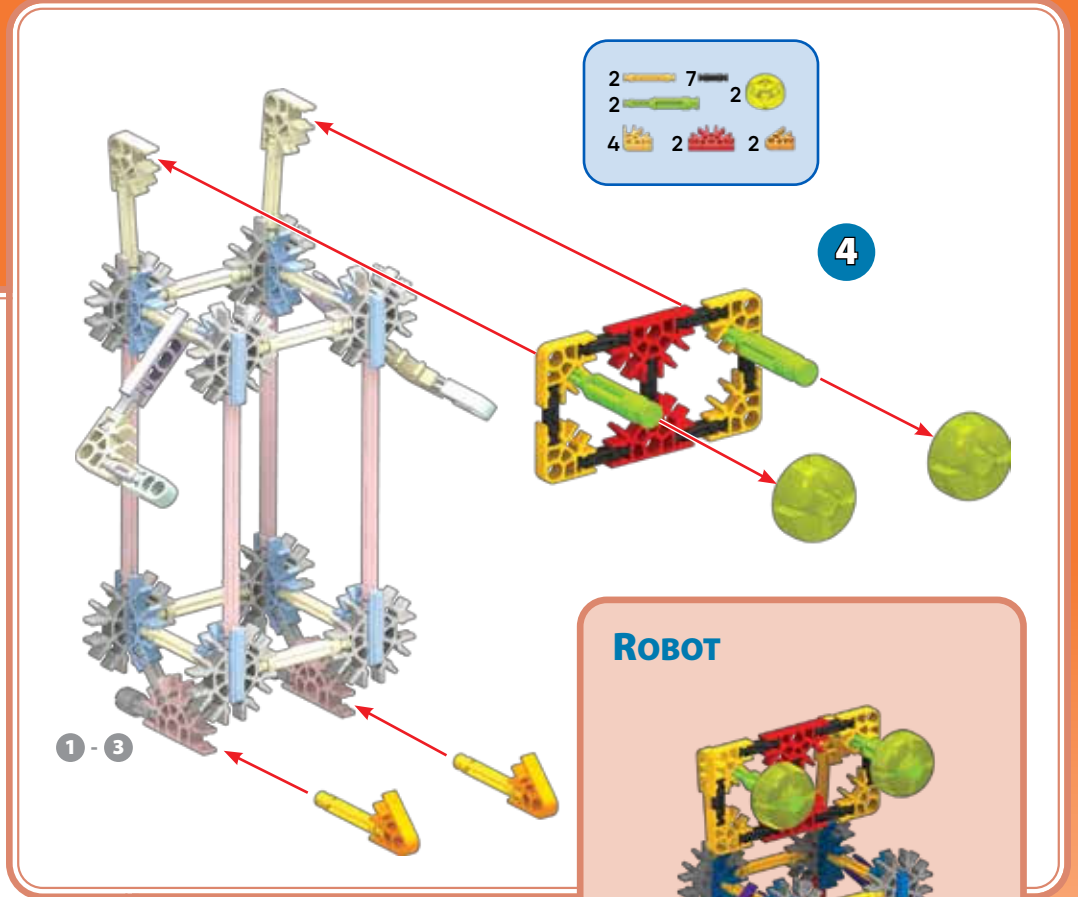
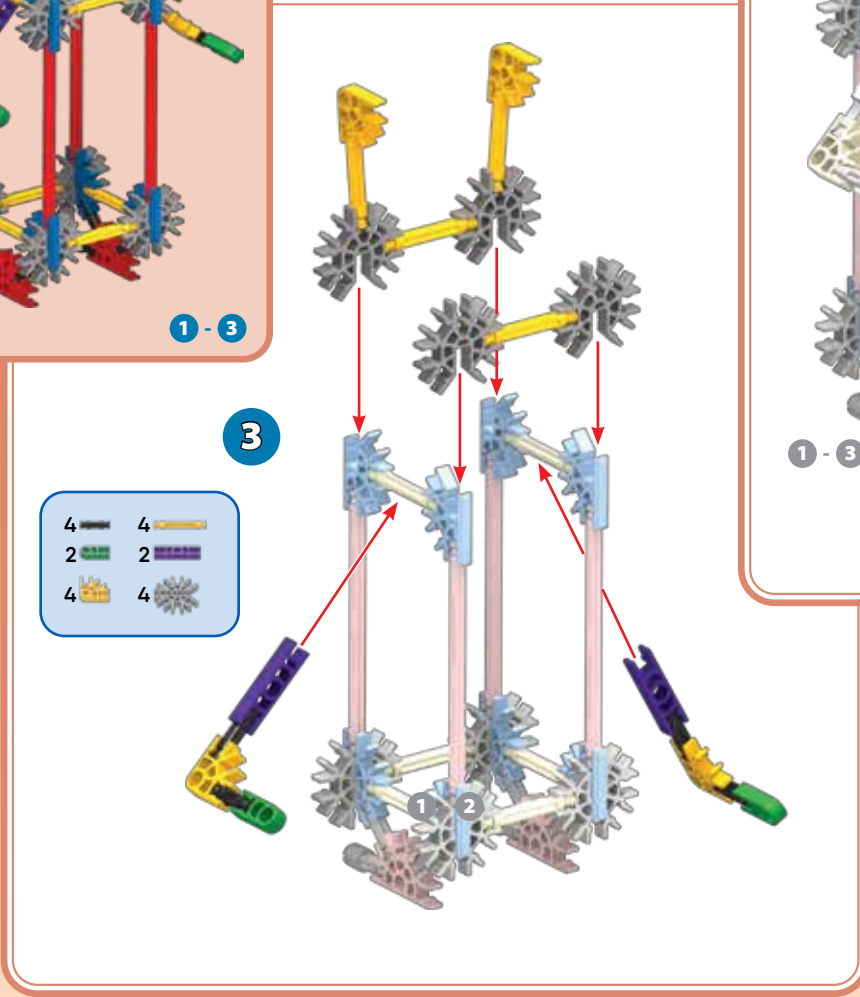
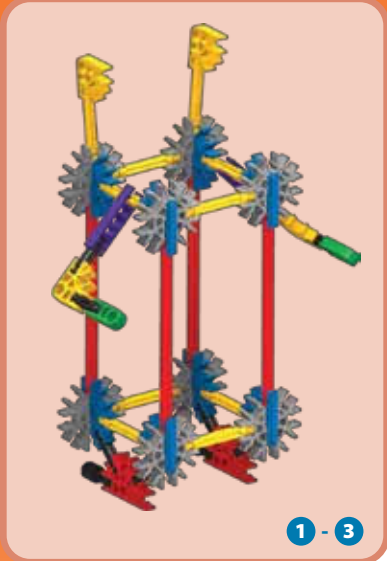

DRILL

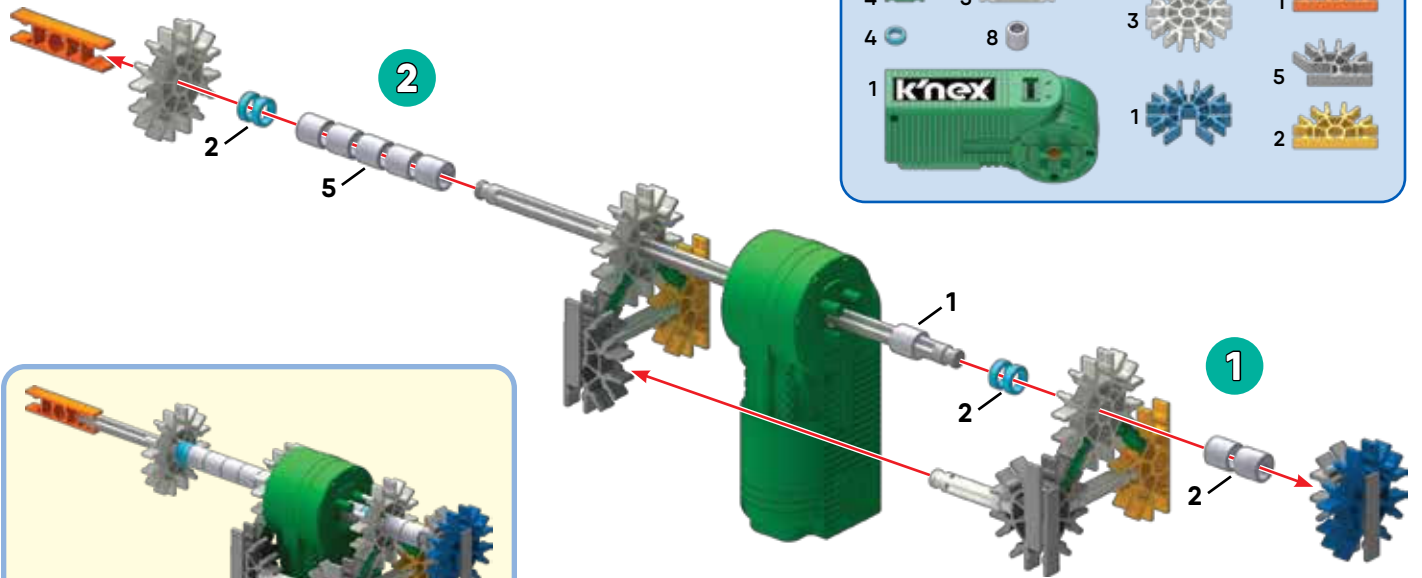

1 - 2

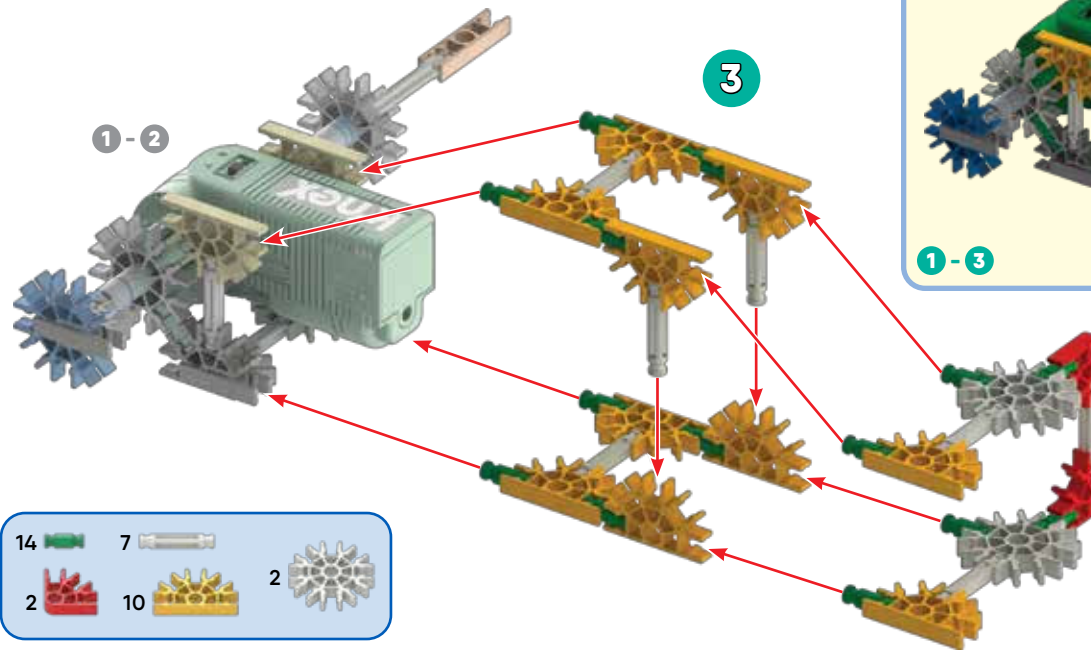

1 - 3

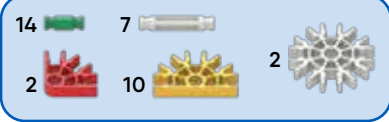

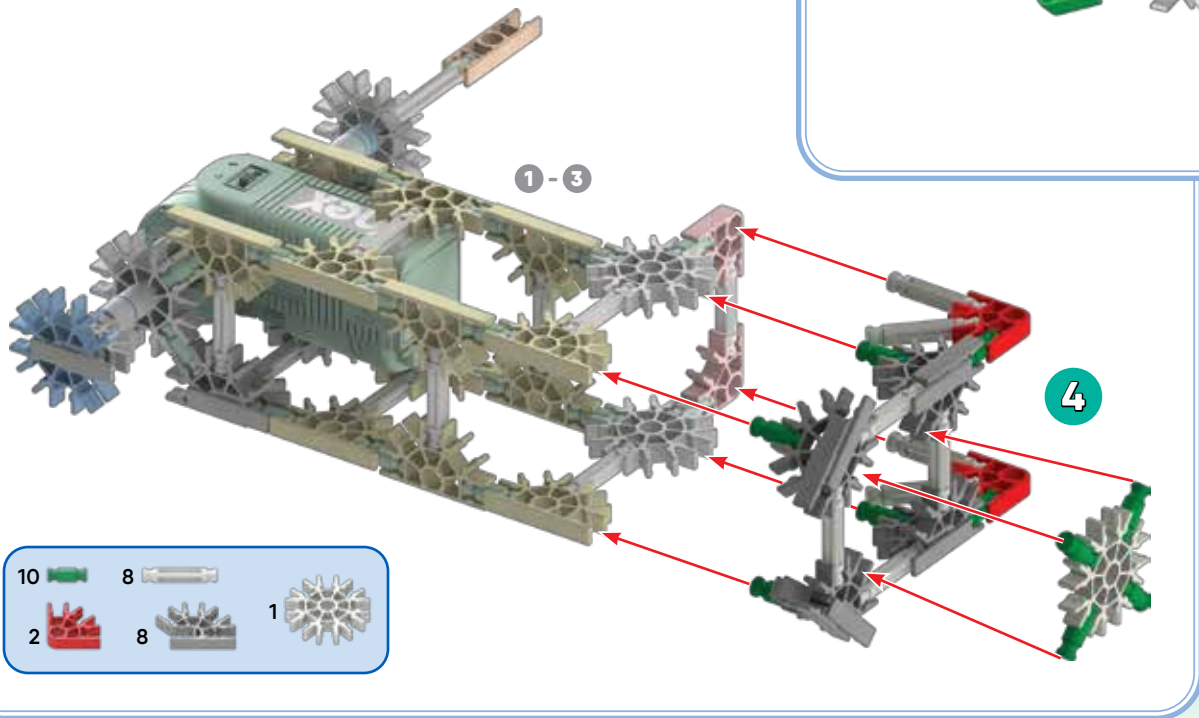
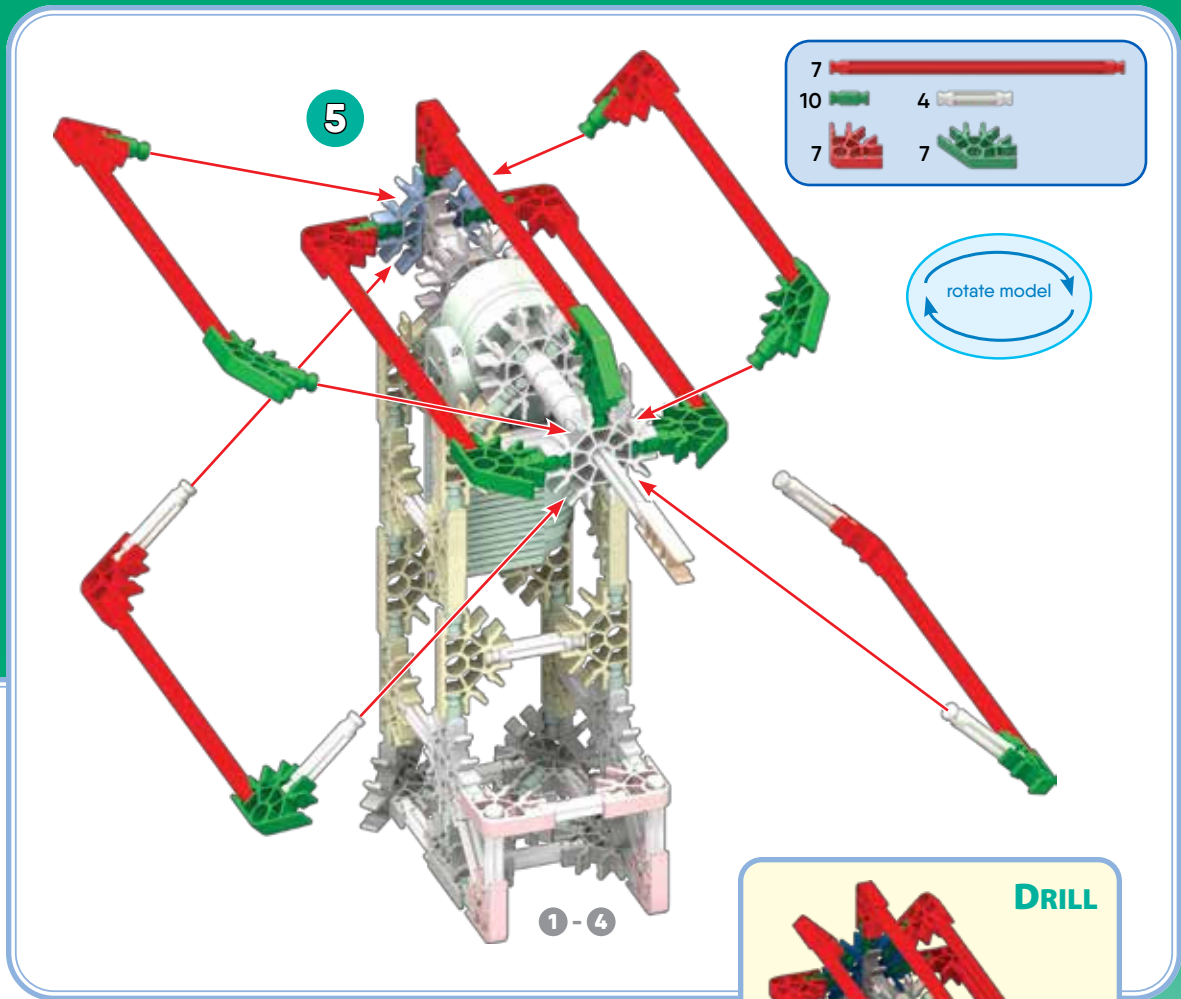
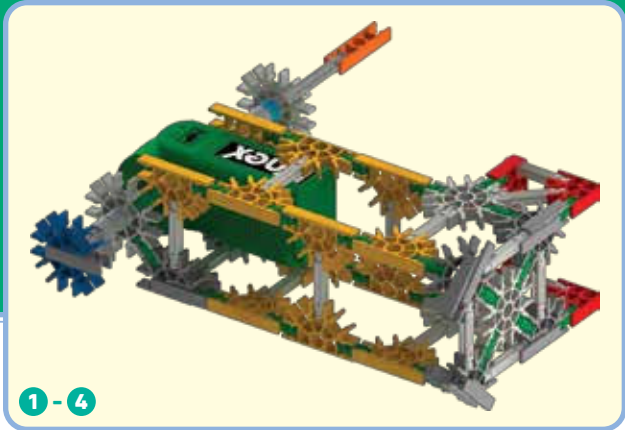

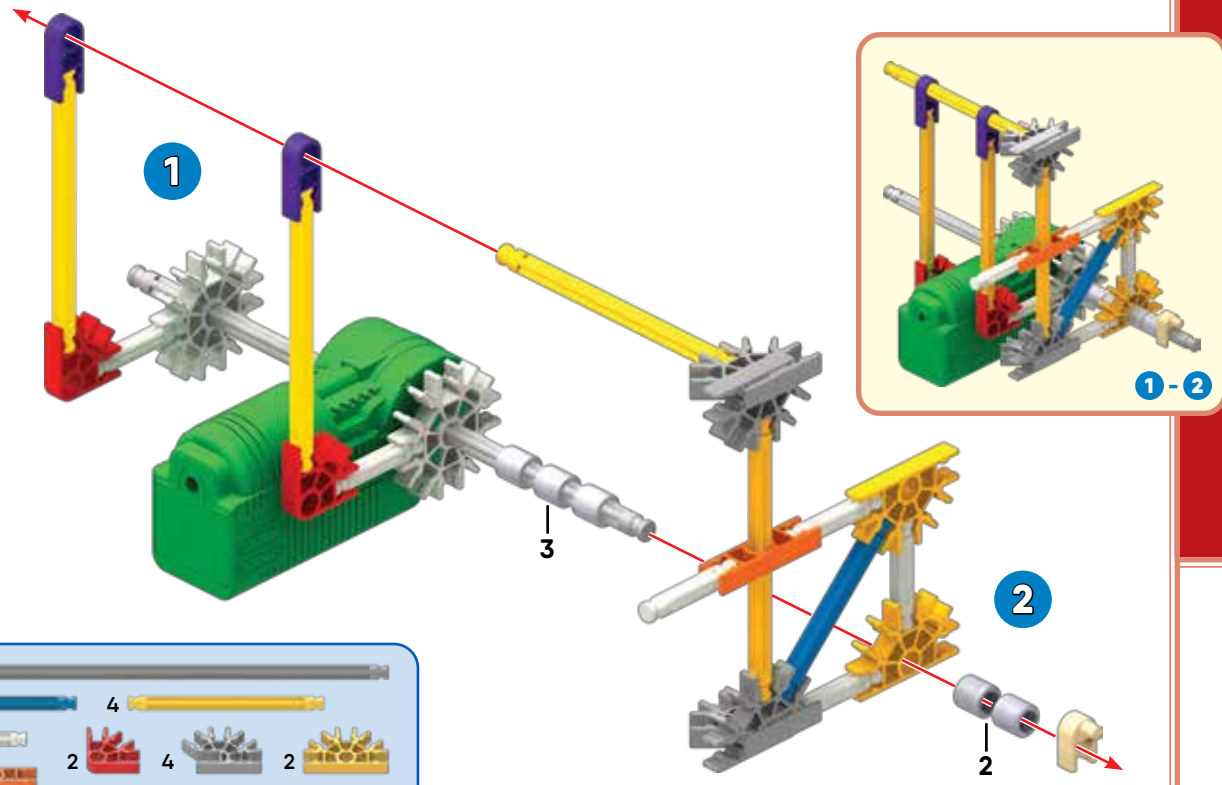

- 1 grey axle
- 1 blue axle
- 6 grey axle
- 1 orange beam
- 1 green motor
- 2 red connector
- 4 grey connector
- 2 yellow connector
- 2 grey gear
- 1 tan connector
- 2 purple connector
- 4 yellow axle
- 2 yellow gear
- 5 grey gear

- 3 blue axle
- 4 grey axle
- 2 yellow gear
- 1 blue axle
- 5 grey axle
- 4 grey connector
- 1 tan connector
- 1 orange beam
- 1 grey gear

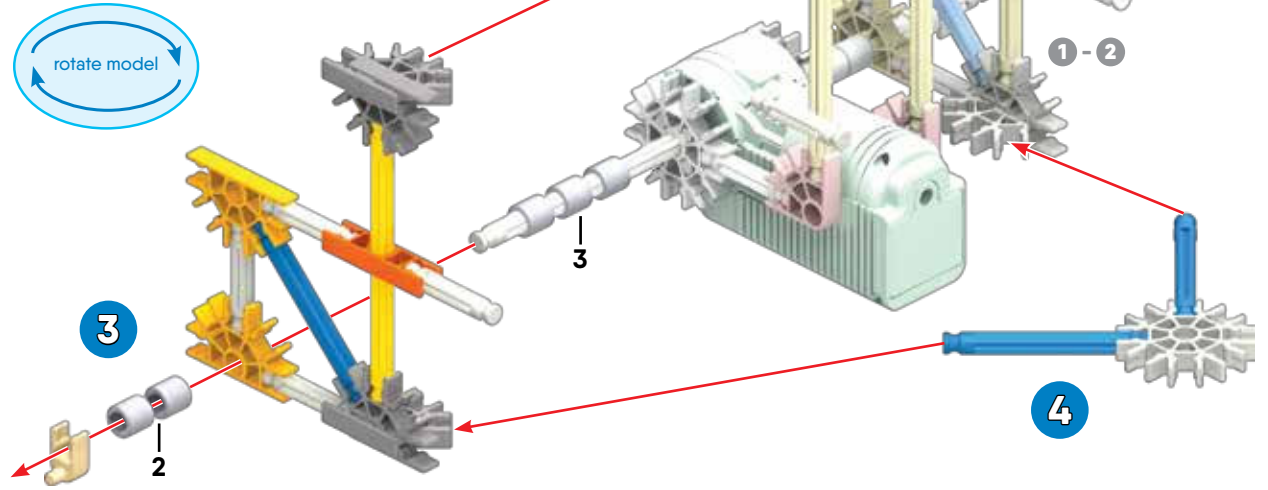

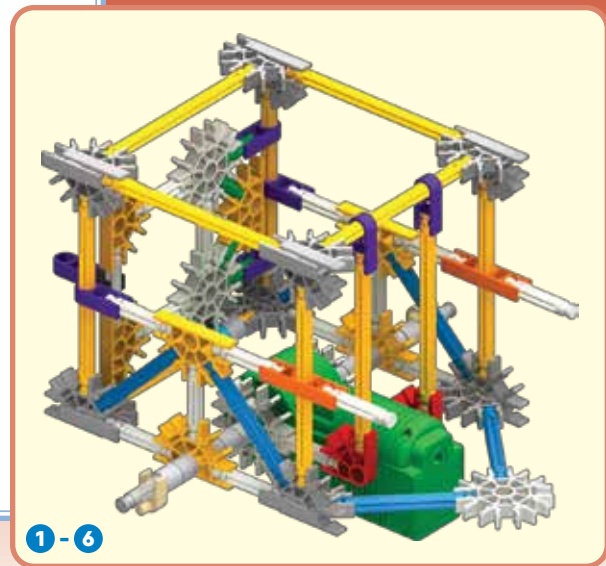
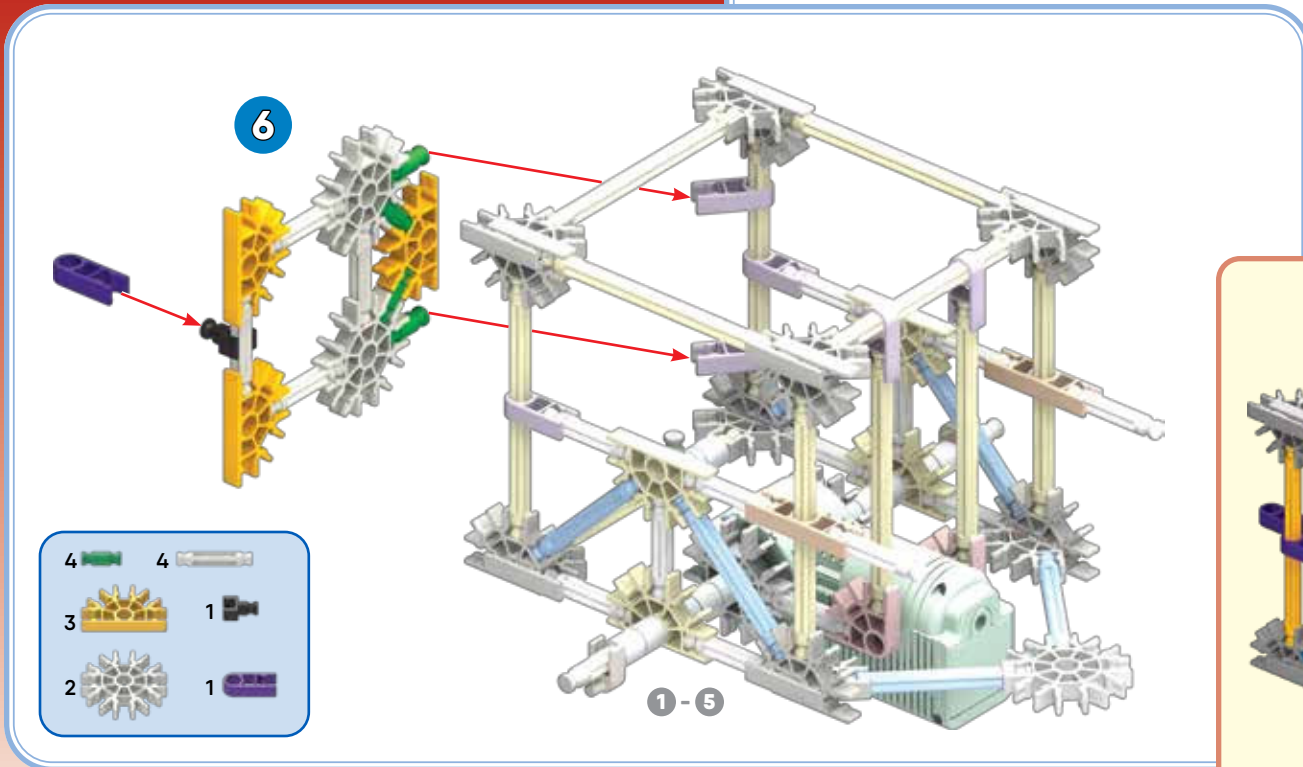
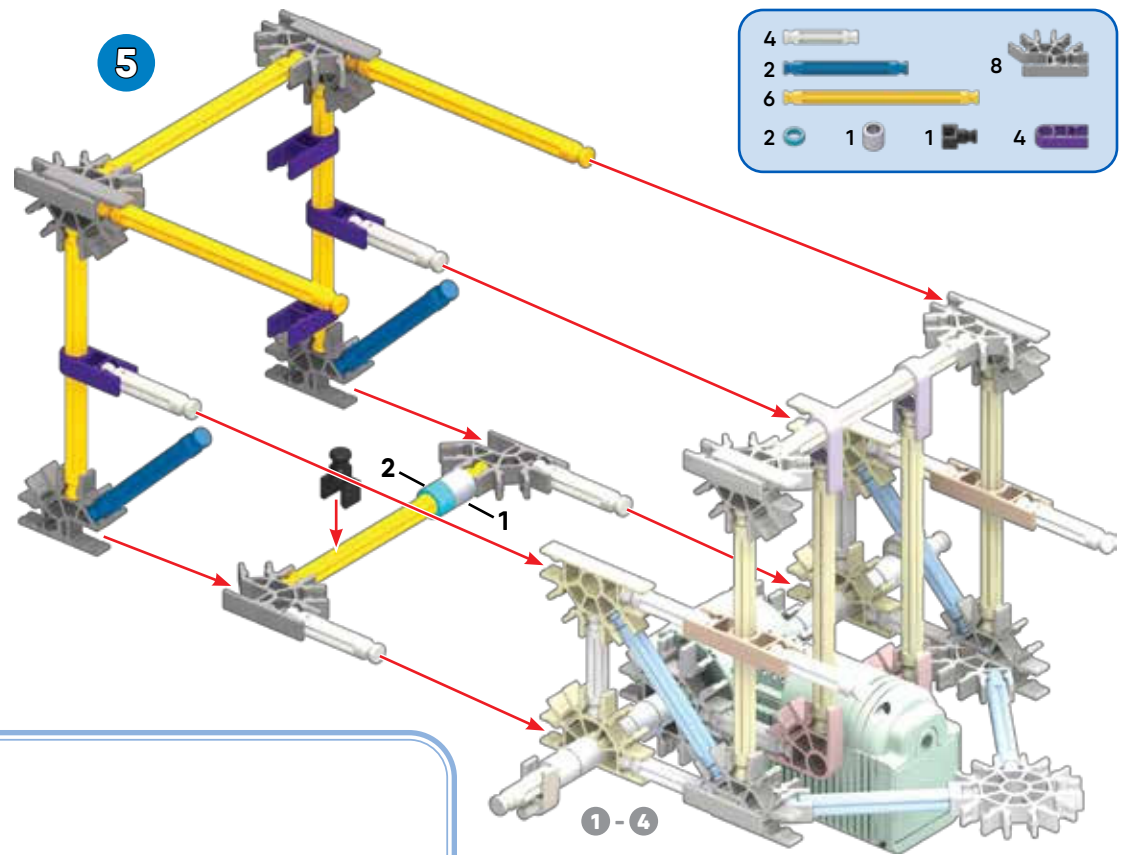
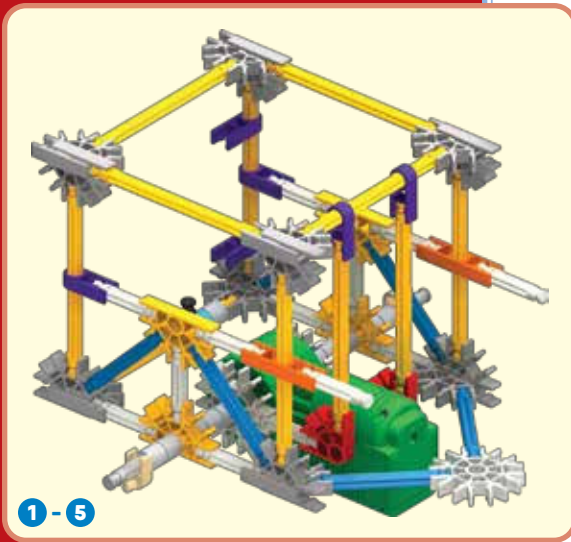

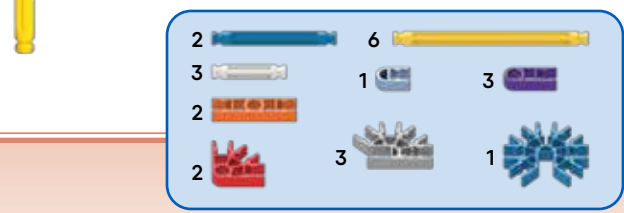
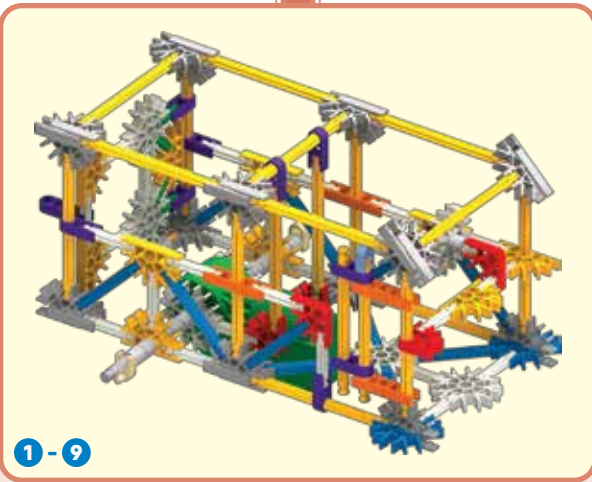
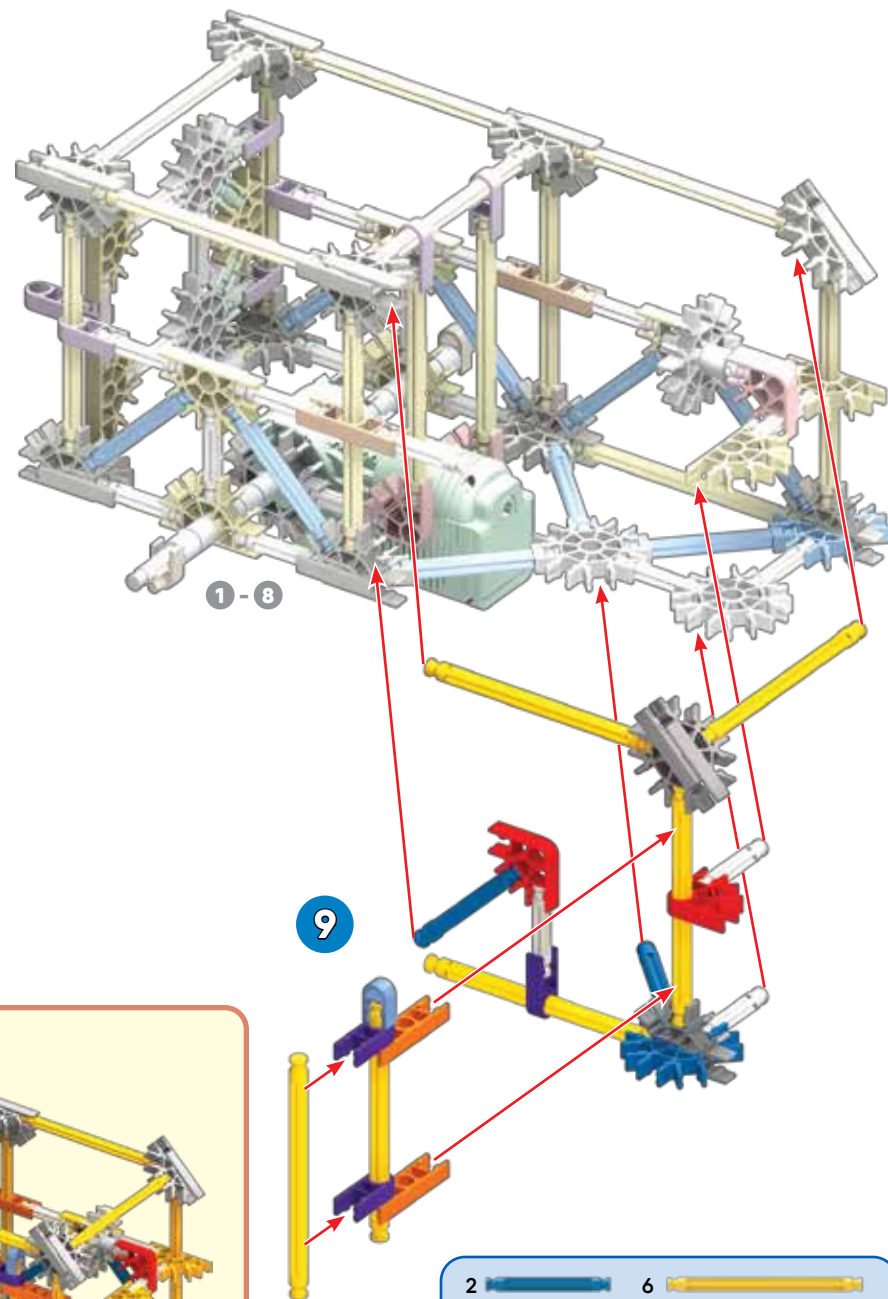
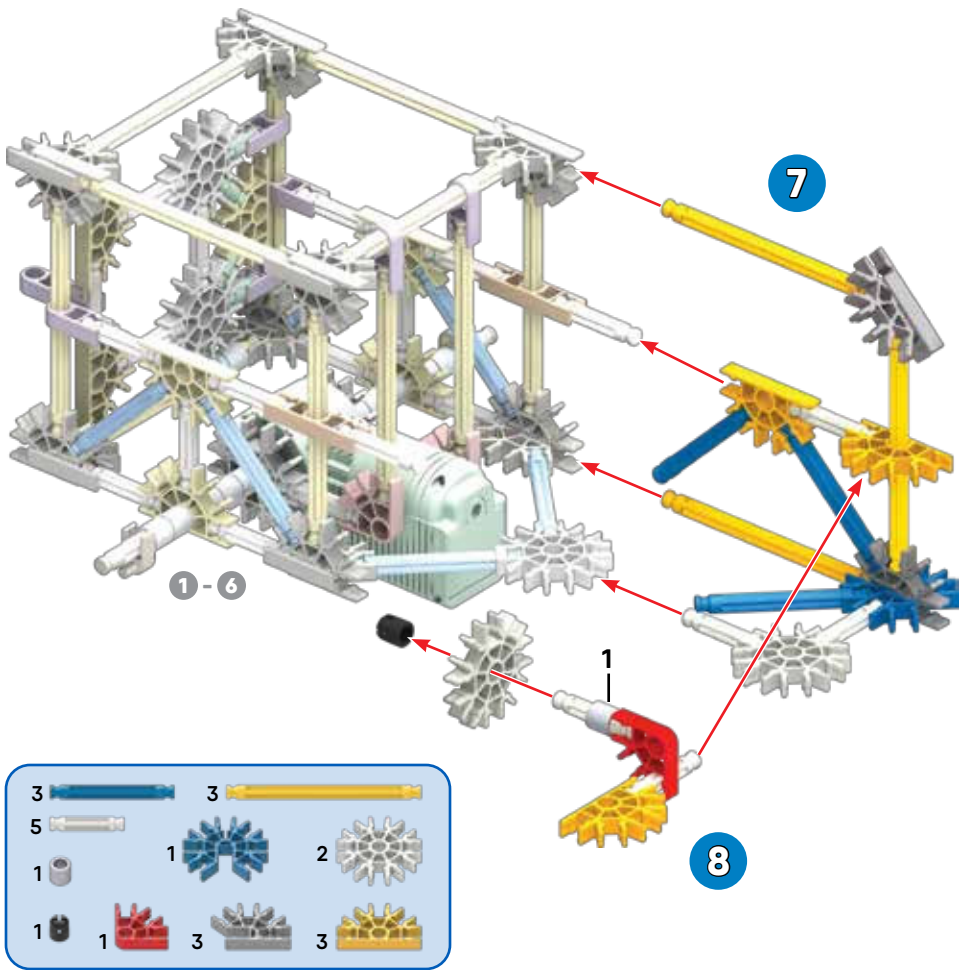

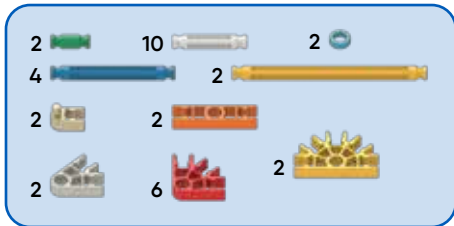
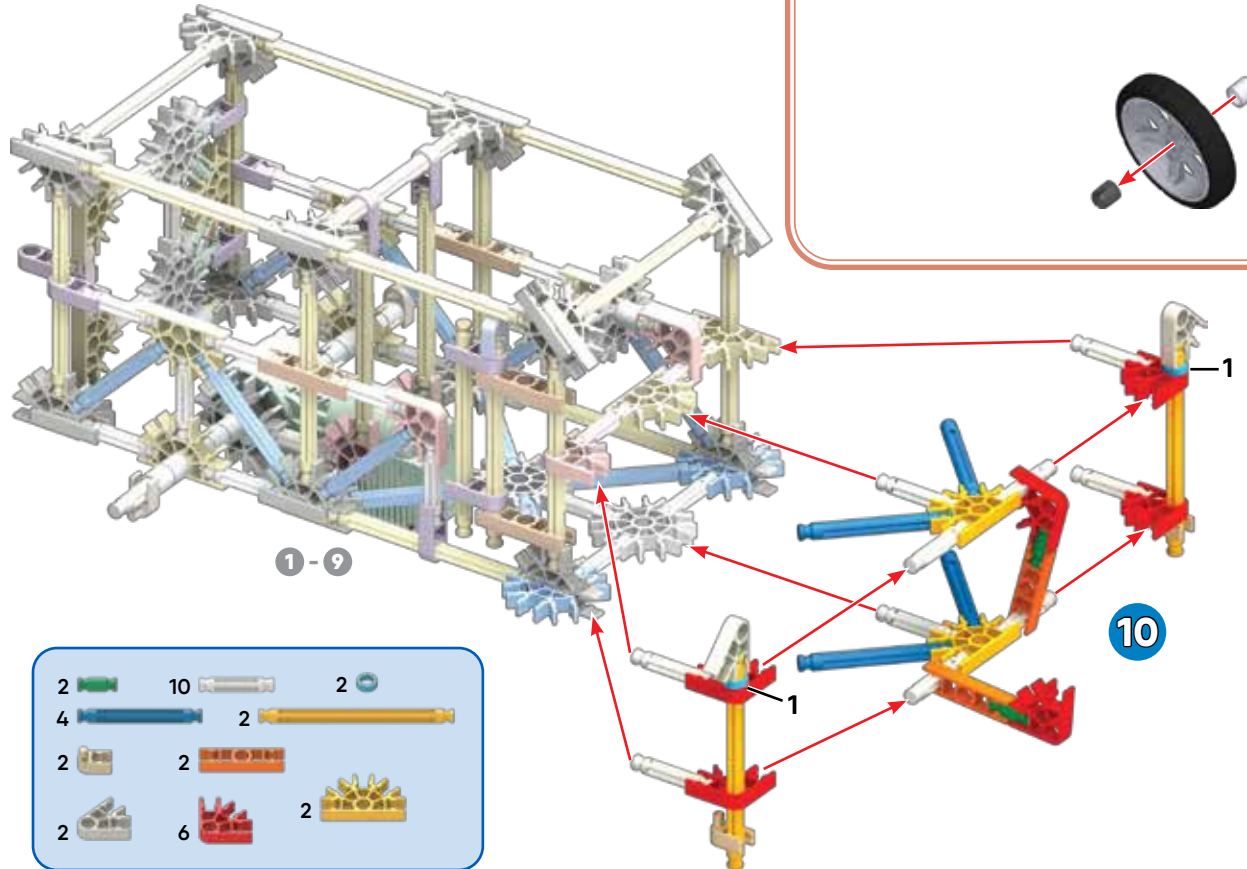
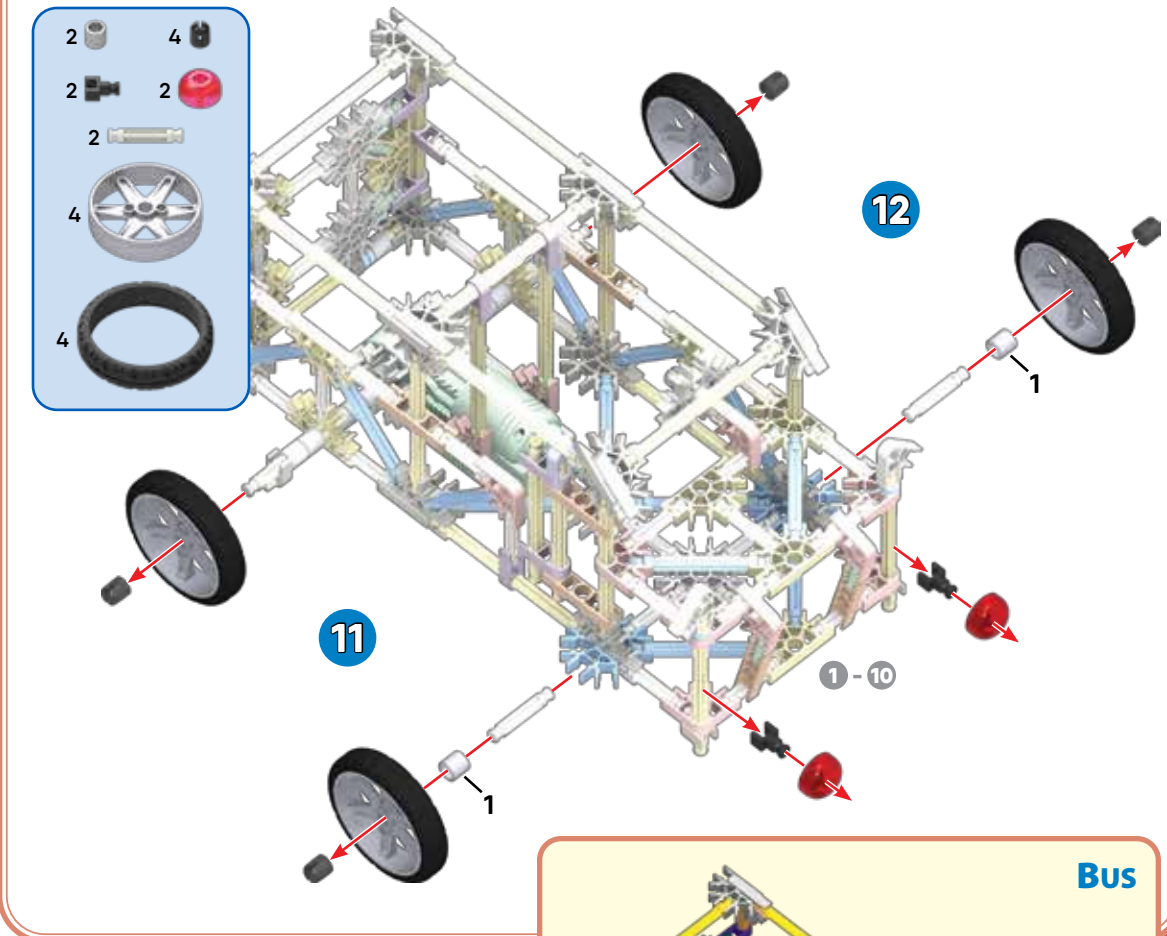
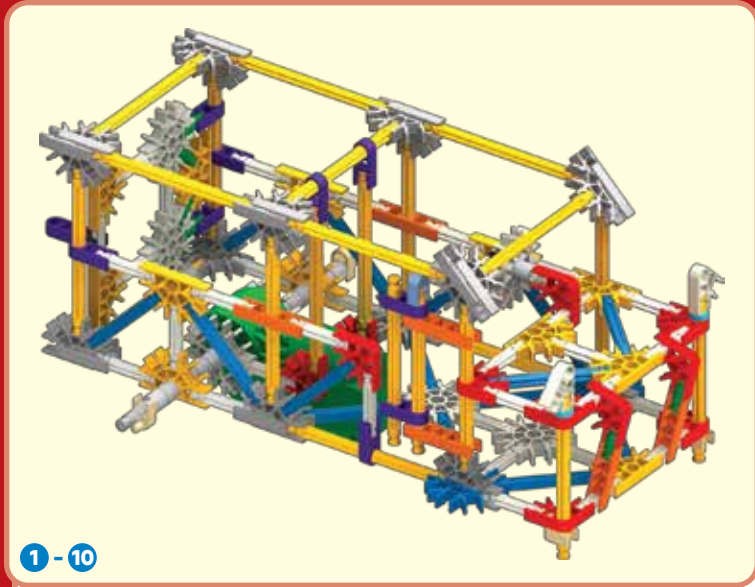

1-12

FERRIS WHEEL

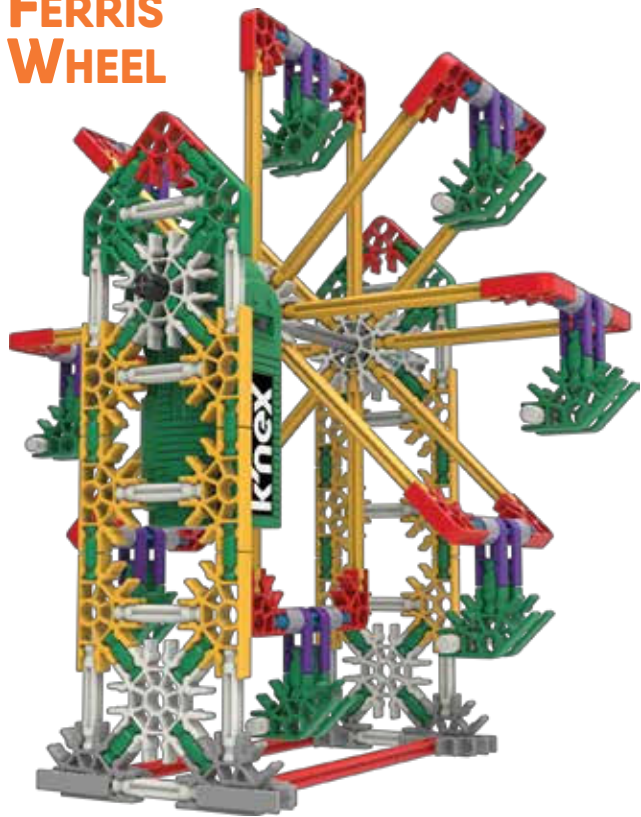

x2

1

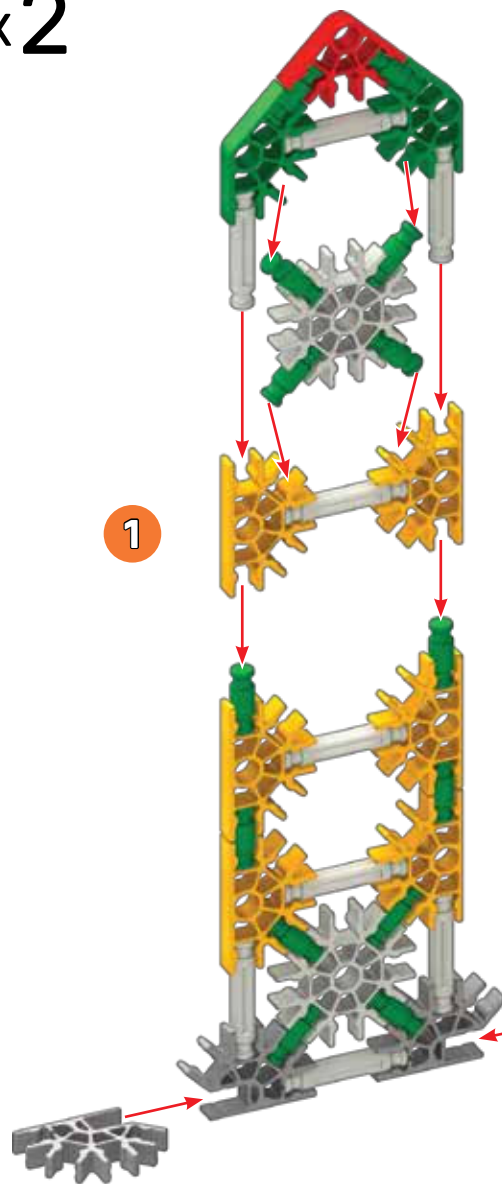

- | | | | |
|----|--|----|--|
| 2 | | 18 | |
| 28 | | 4 | |
| 2 | | 4 | |
| 8 | | 12 | |

x2

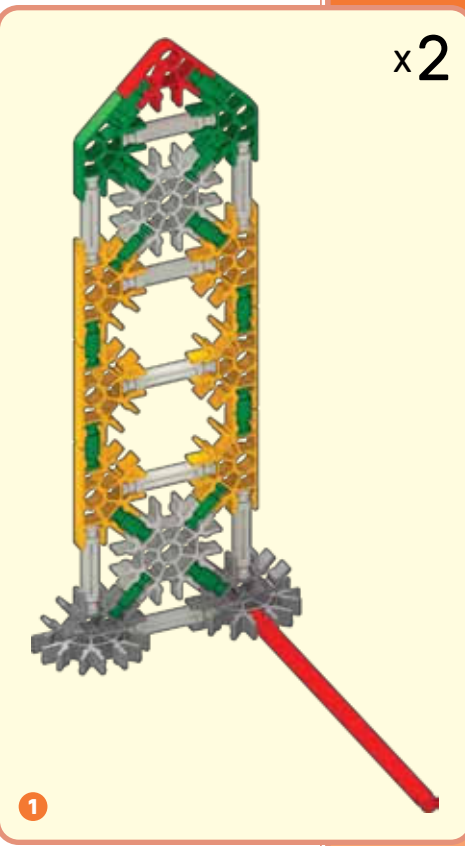

Did you install 2 AA (or LR6) batteries in the motor?

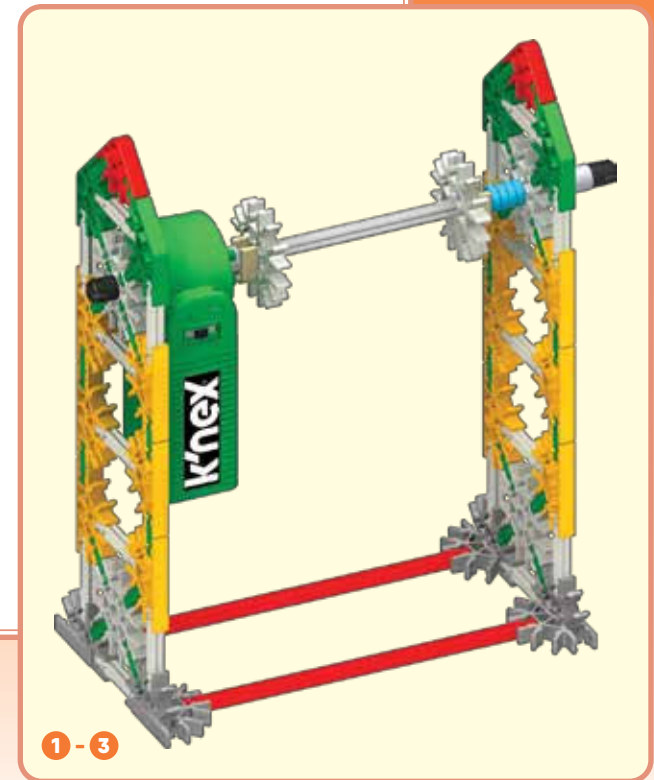
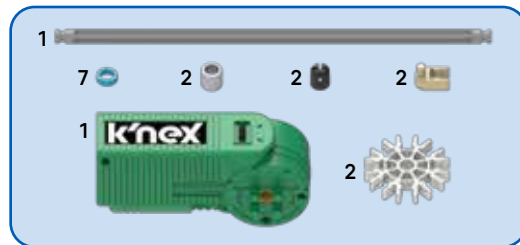
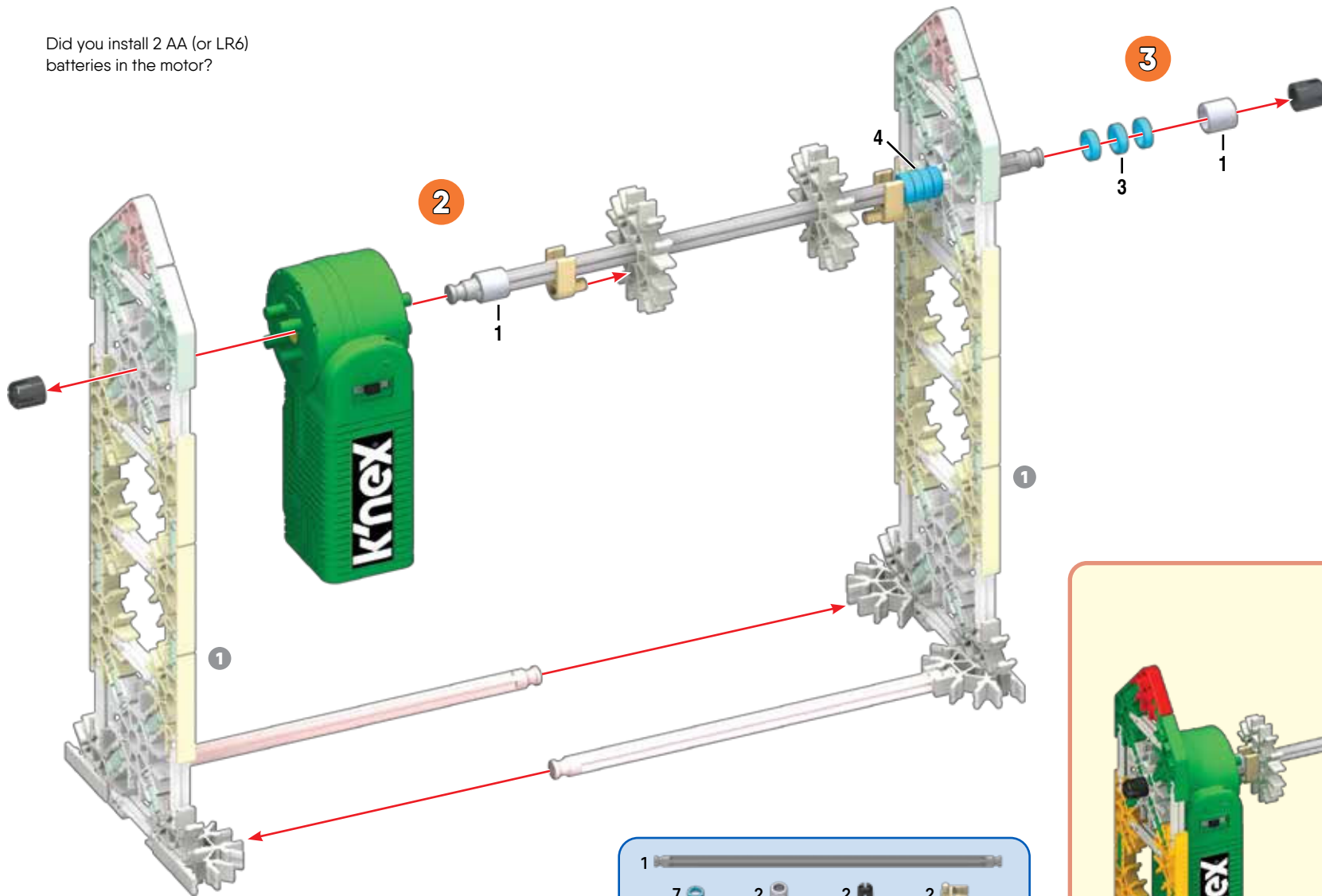

x8

4

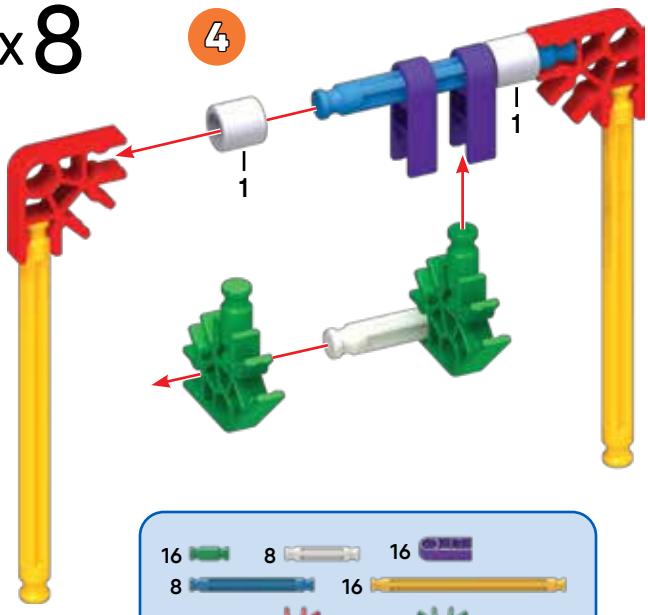

16	8	16
8	16	
16	16	16

x8



4

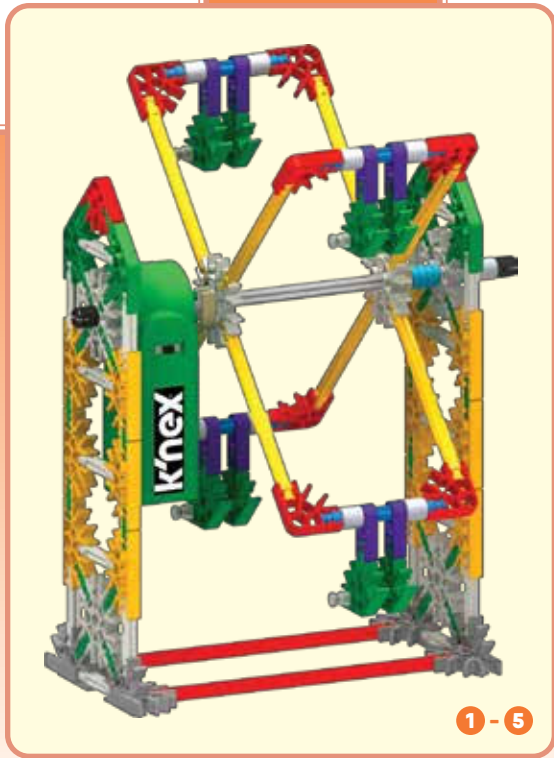

1 - 5

5

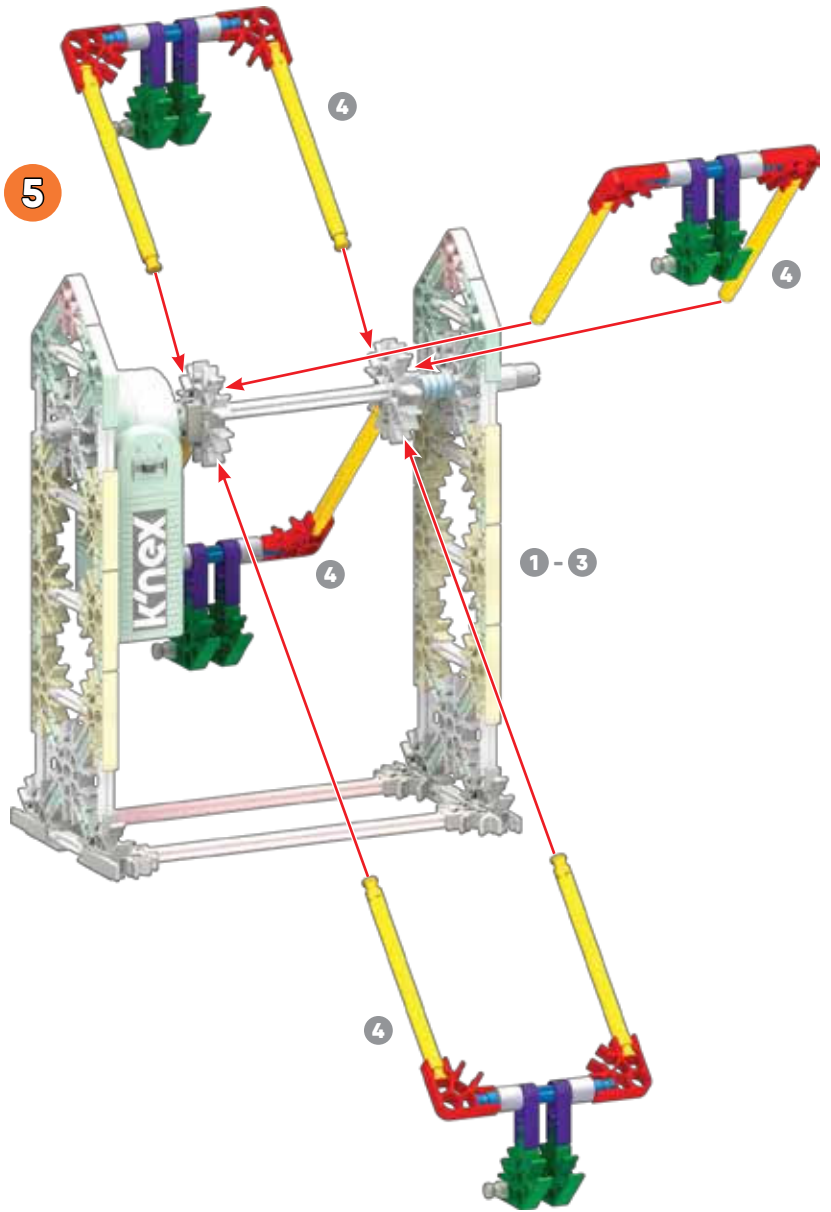

FERRIS WHEEL

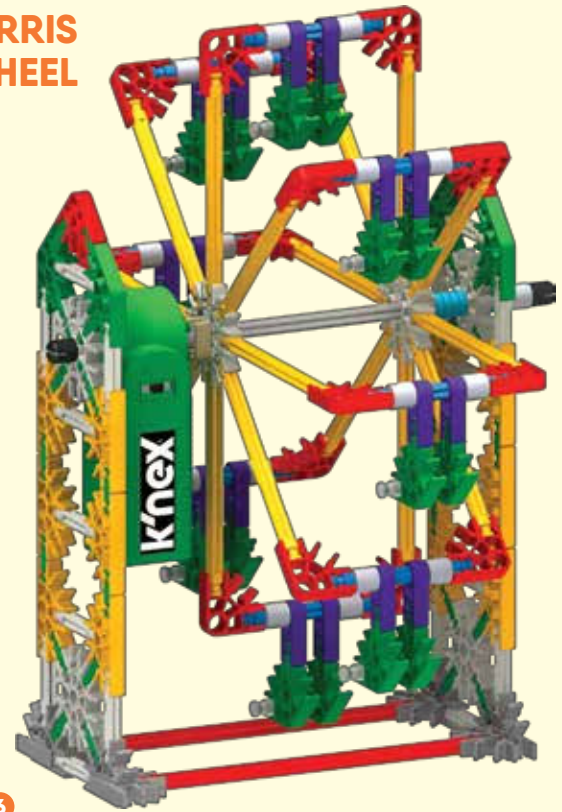

1 - 6

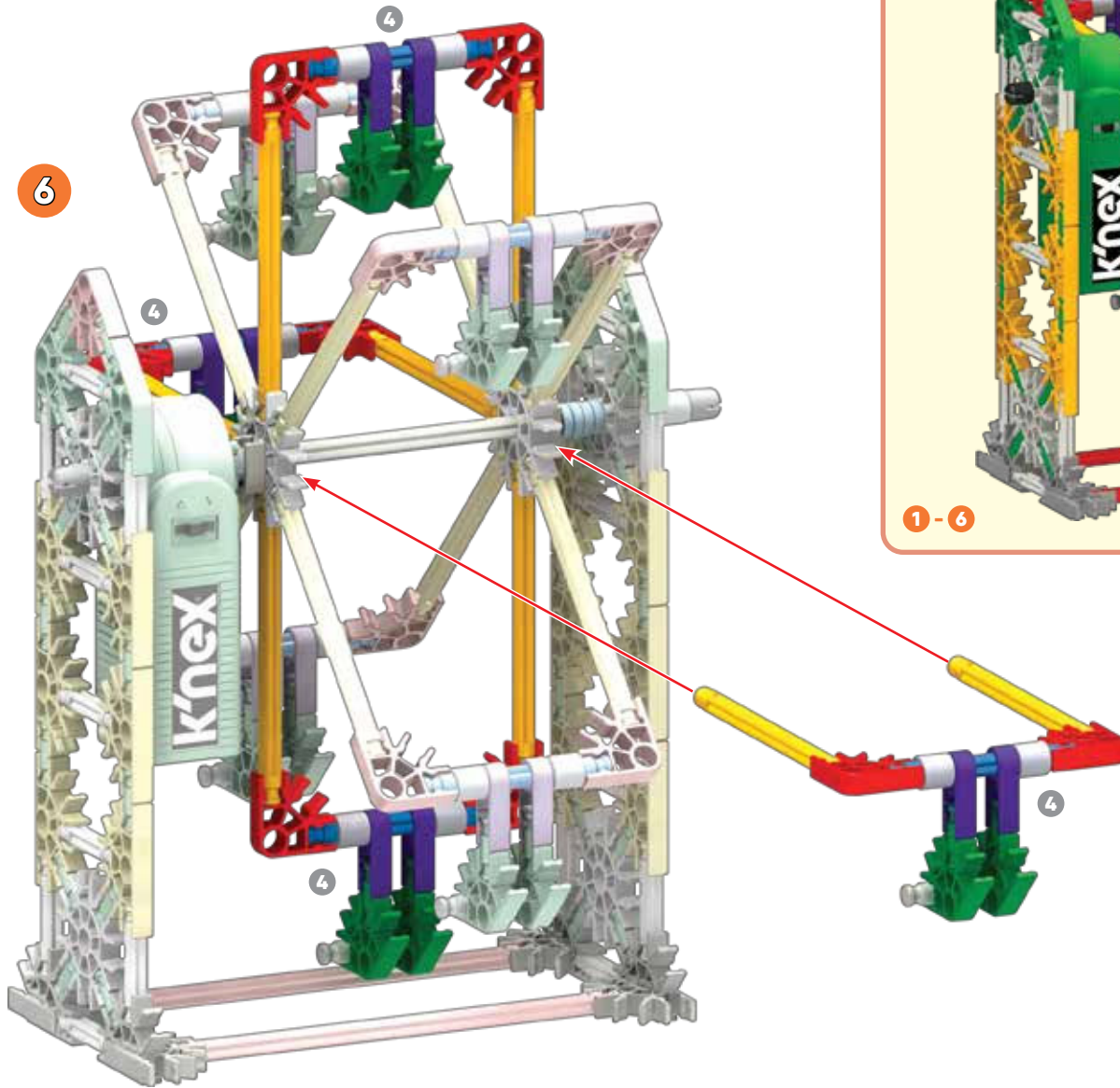

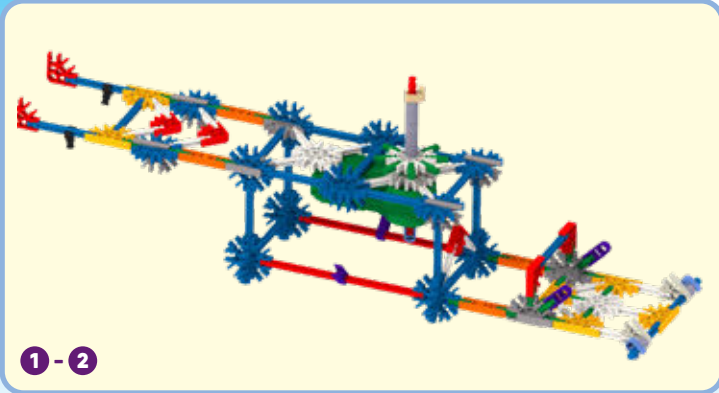
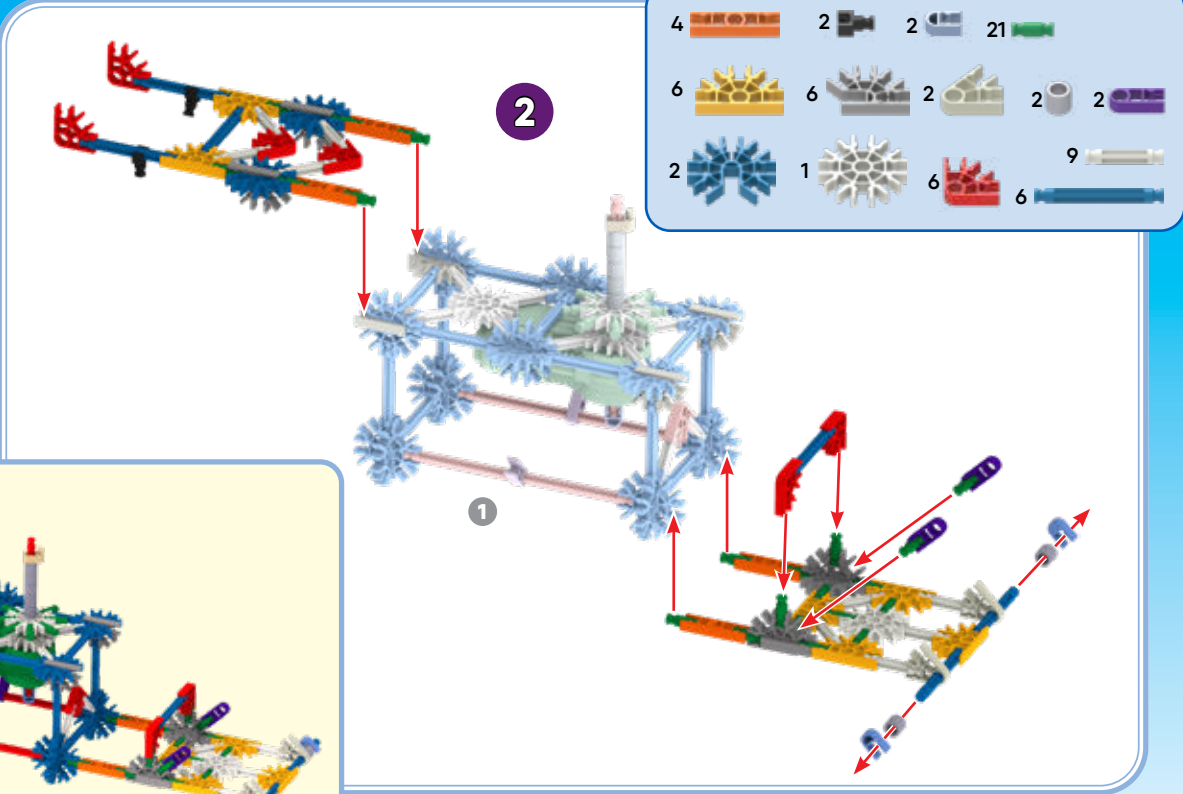
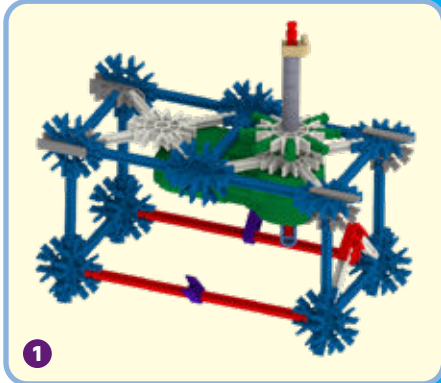
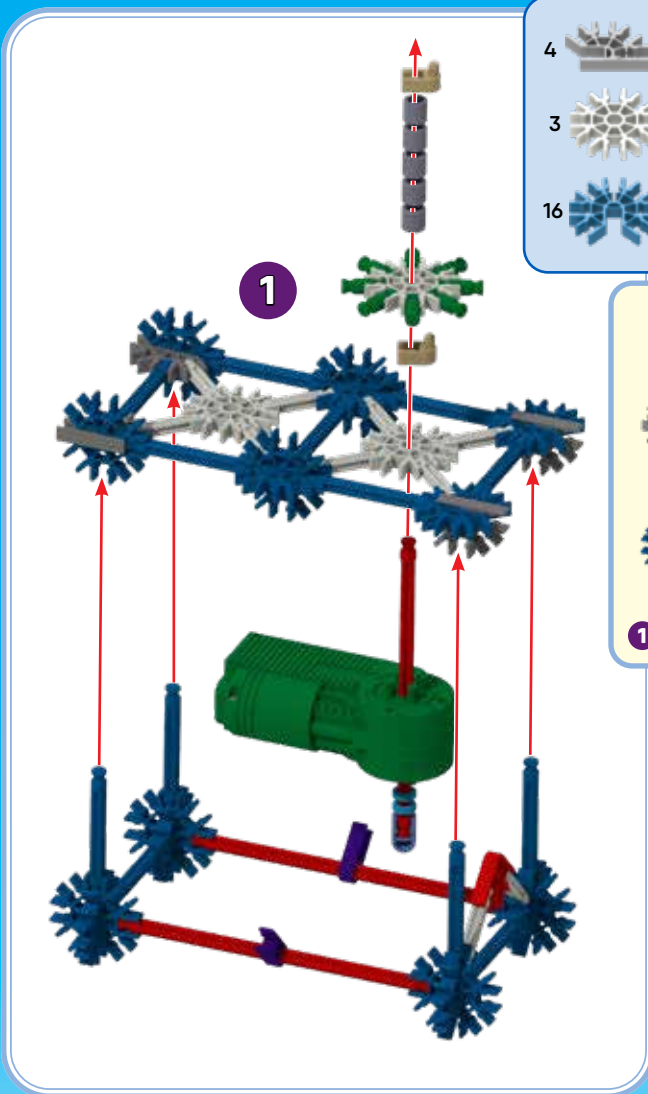

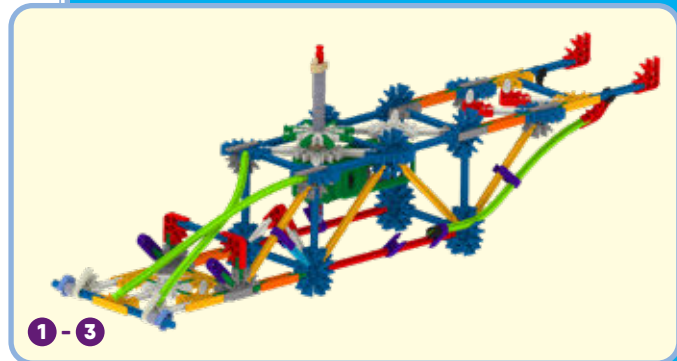
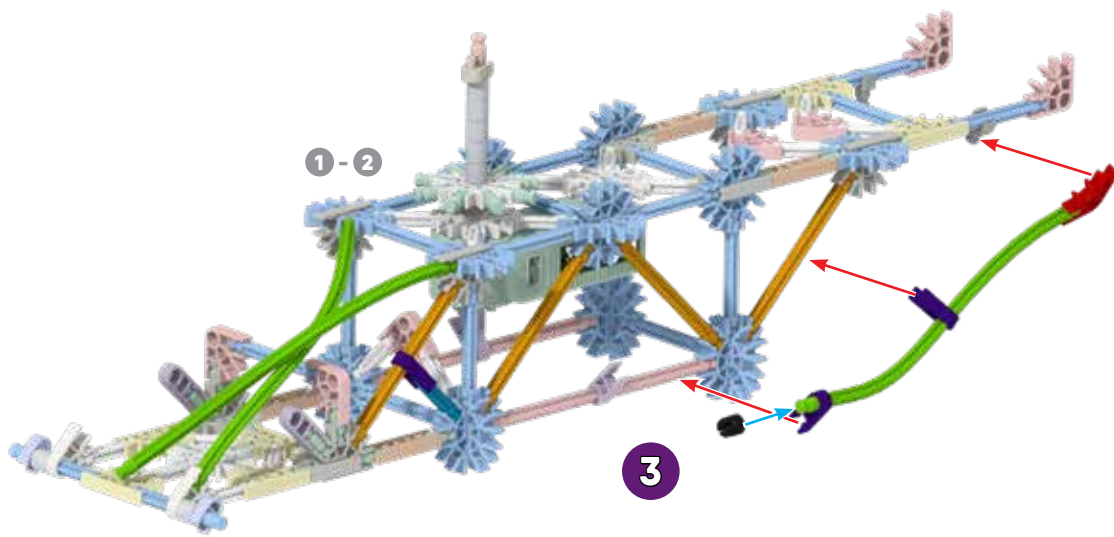

Parts list for step 3:

- 1 black bush
- 1 grey axle
- 3 purple bush
- 4 yellow beam
- 1 blue bush
- 3 green beam

Parts list for step 4:

- 1 grey axle
- 1 red gear
- 1 black bush
- 1 blue bush
- 1 grey axle
- 4 purple bush
- 4 yellow beam
- 10 grey axle
- 1 blue bush
- 3 green beam

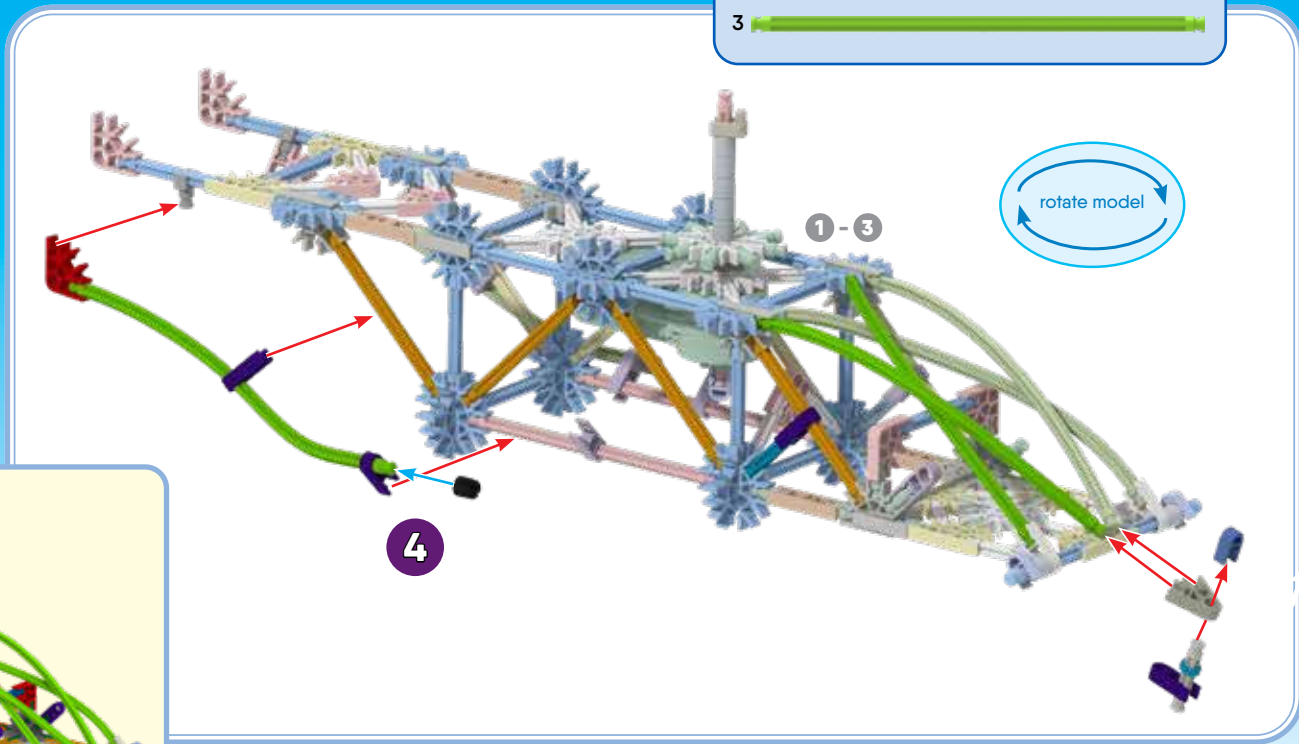

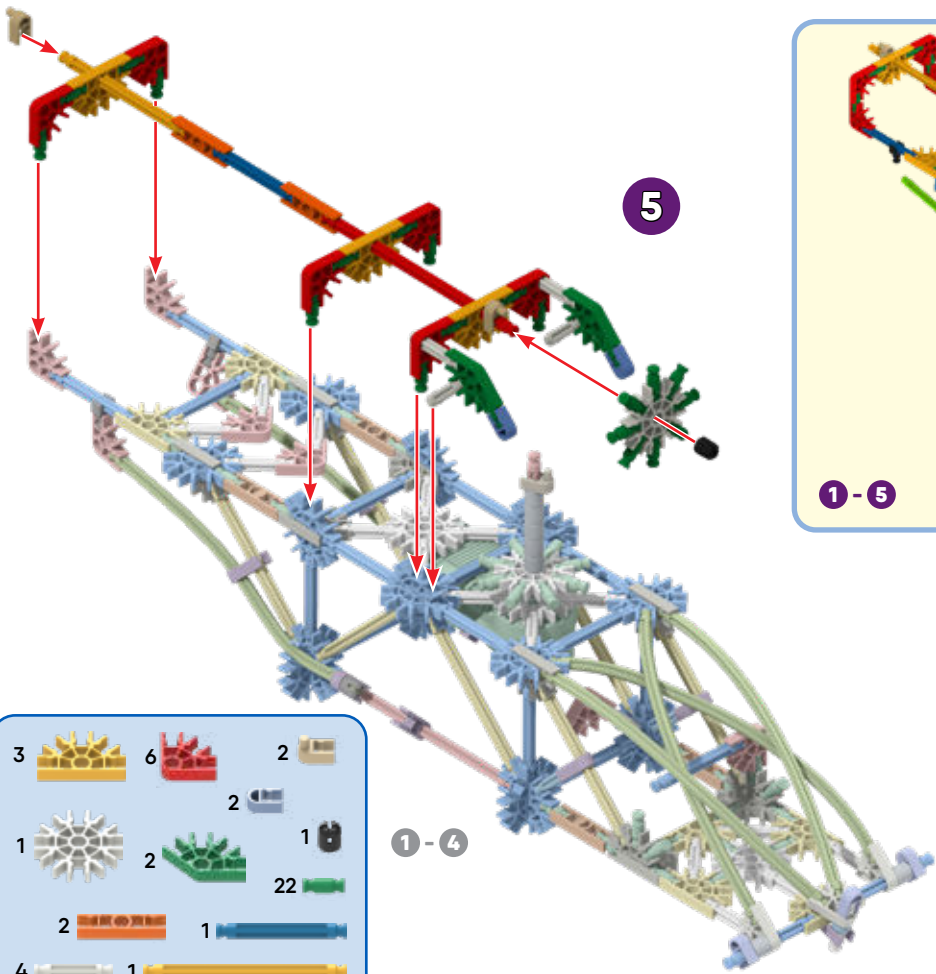

5

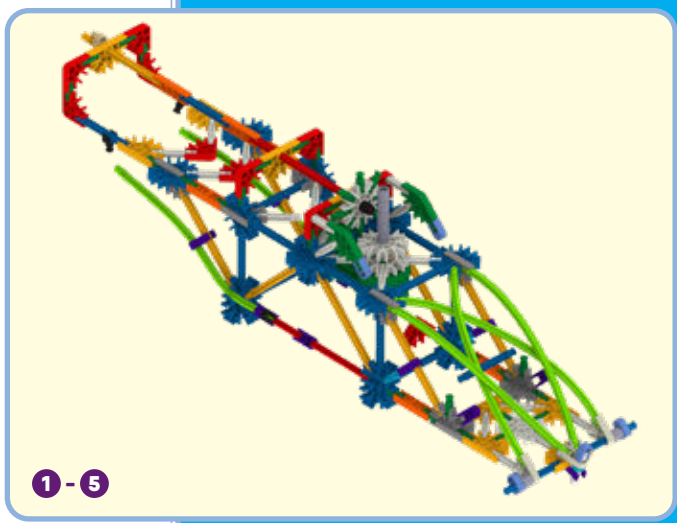

1-5

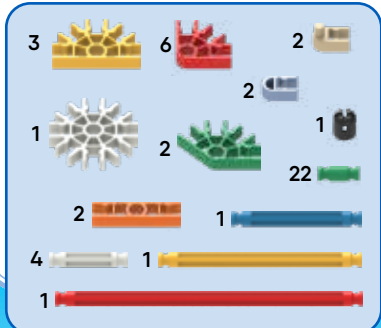

1-4

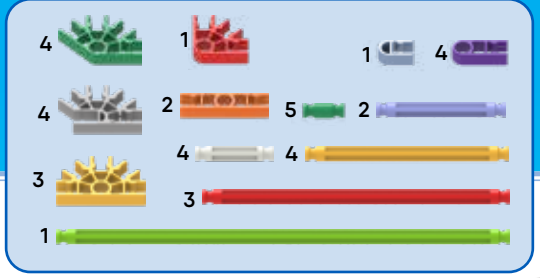

1-5

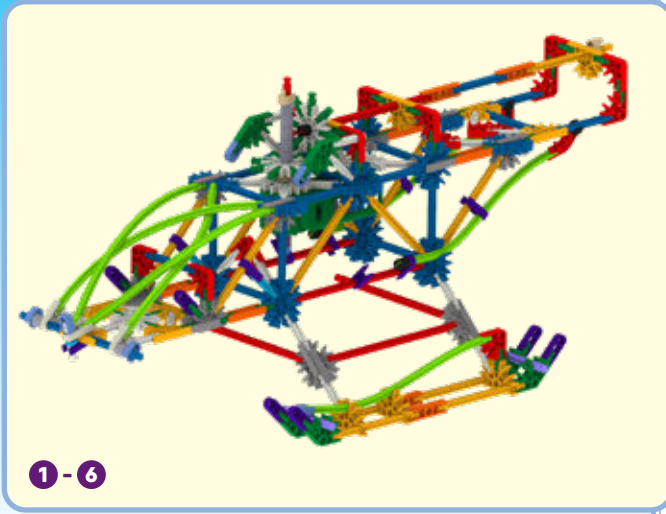

1-6

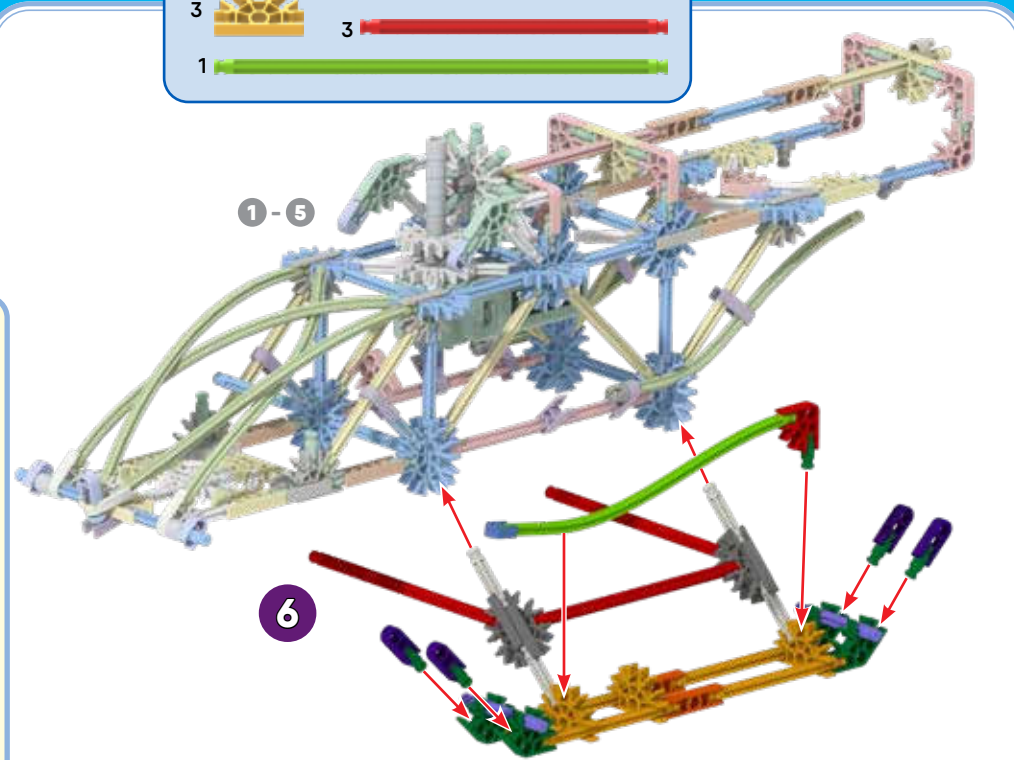

6

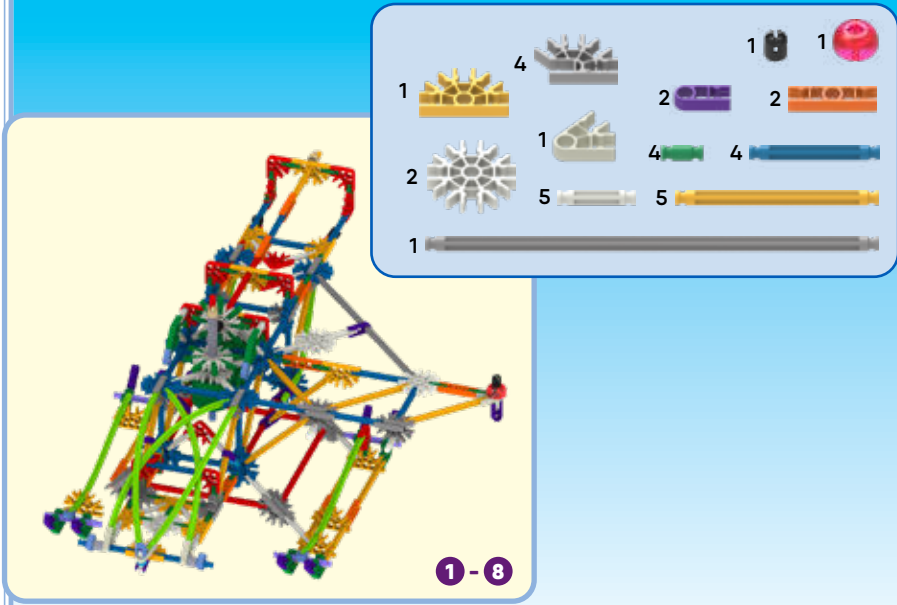
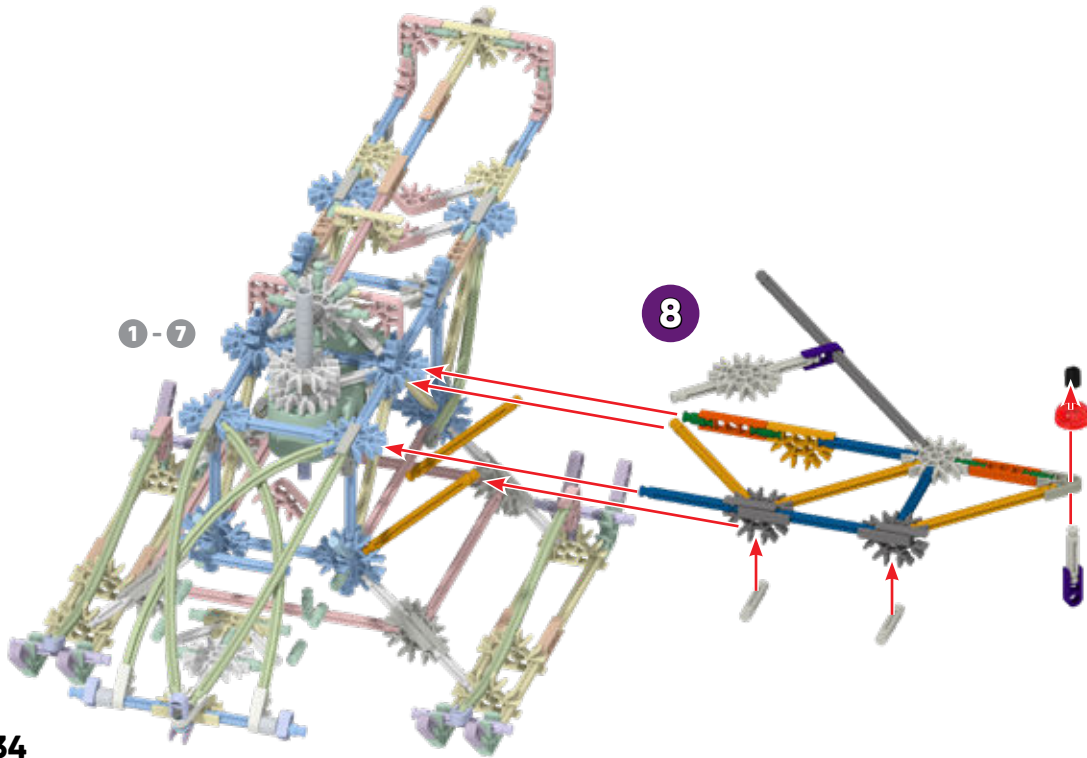
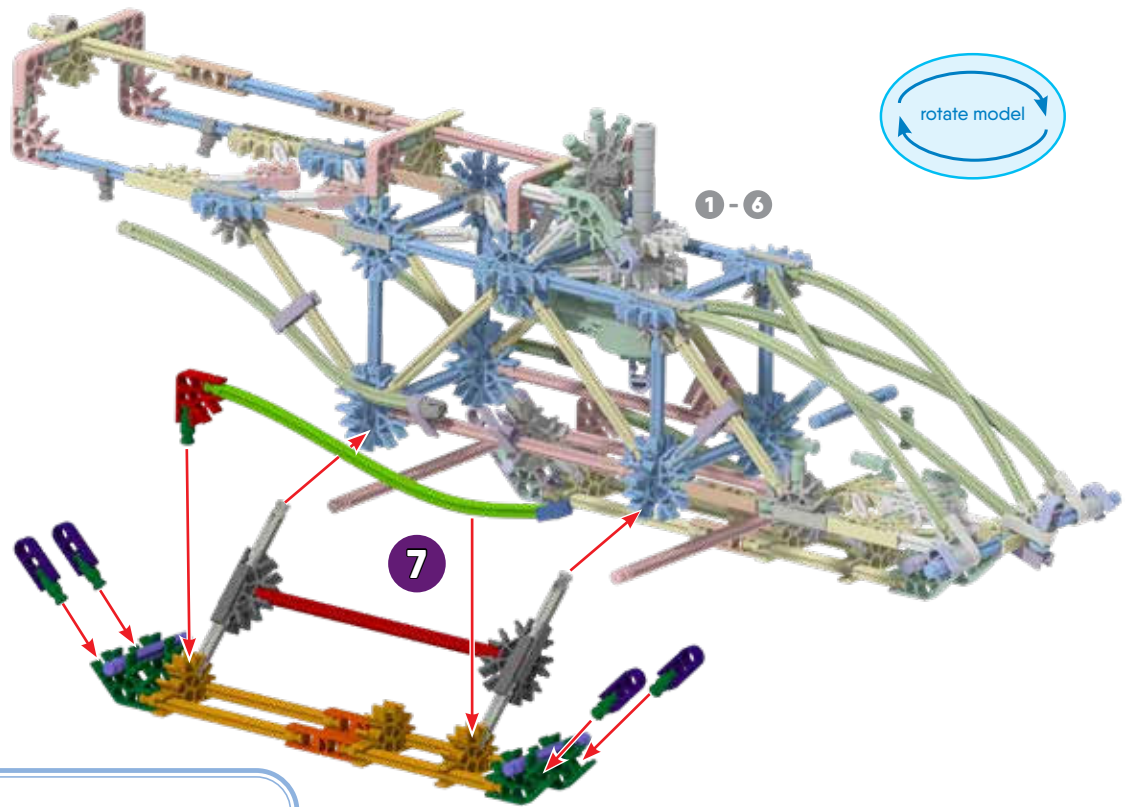
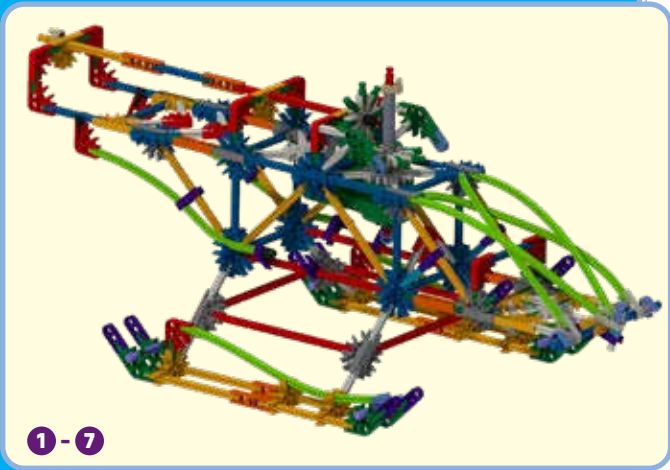

rotate model

1-8

9

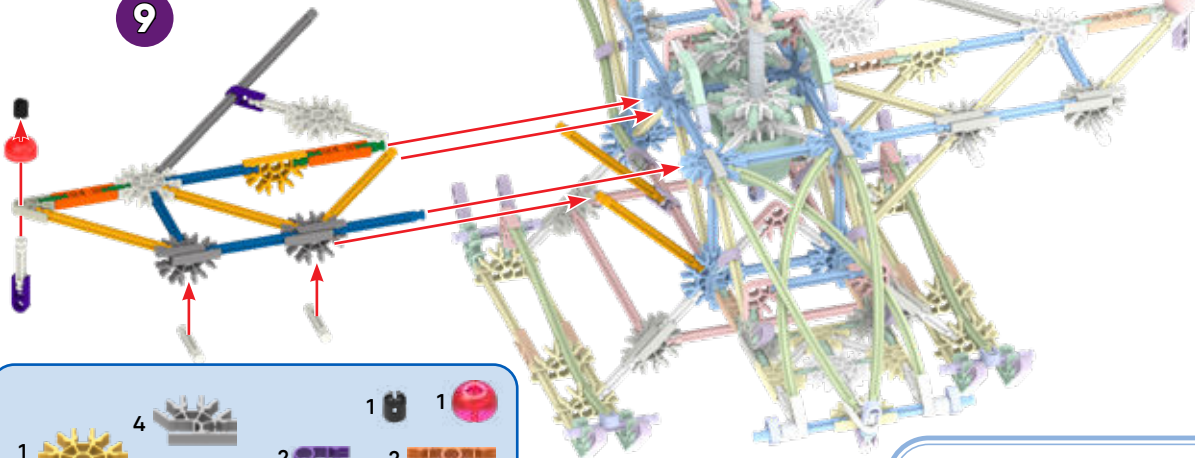

- 1
- 4
- 1
- 1
- 2
- 2
- 2
- 1
- 4
- 4
- 5
- 5
- 1

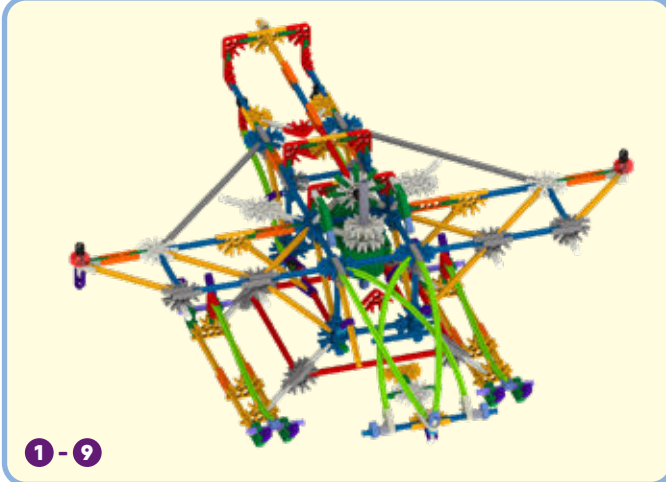

1-9

- 2
- 2
- 2
- 4
- 2
- 8
- 2
- 8
- 4
- 4
- 8
- 4
- 2
- 4
- 4
- 2
- 4
- 4

COMBO HELICOPTER



1-10

10

1-9

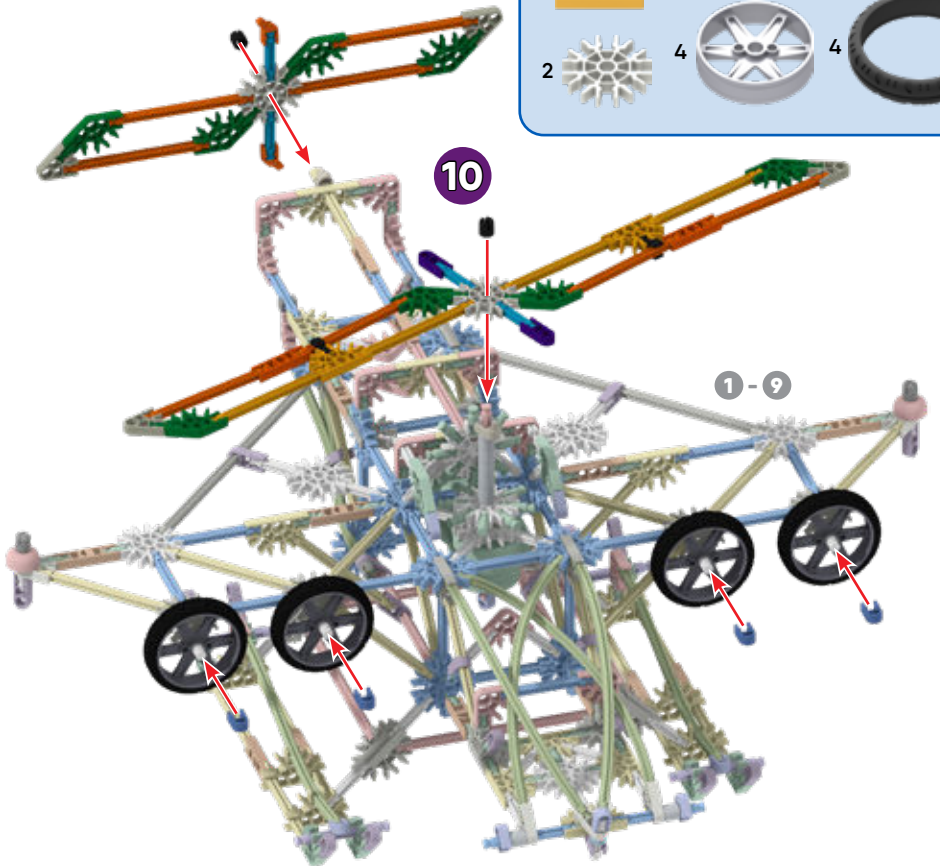

BUILDING IDEAS

For instructions of these models go to www.basicfun.com/knex and enter code 85043.

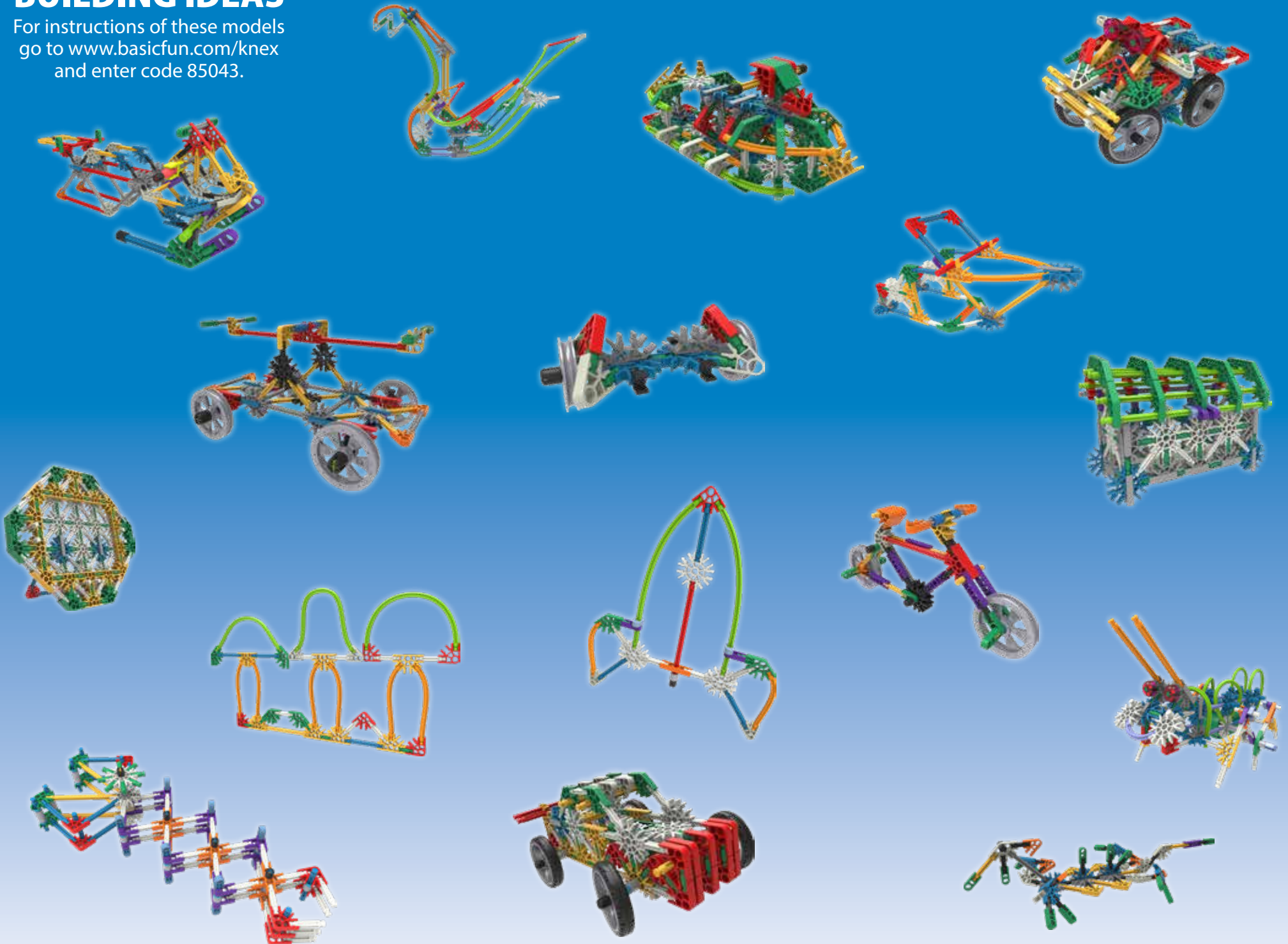

BUILDING IDEAS





BUILDING IDEAS

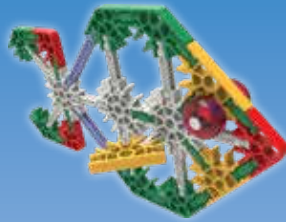
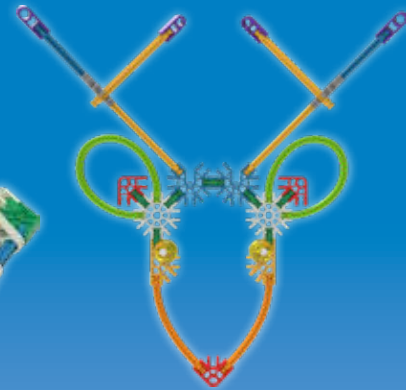
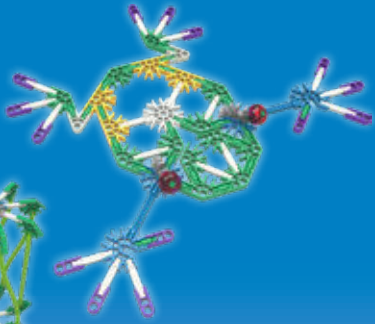
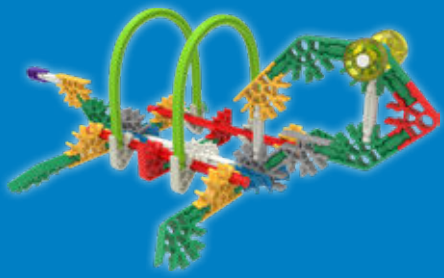



MOTORIZED MODELS BUILDING SET

Intermediate 60 Model
15211*



basicfun.com

@knex facebook.com/knex

©2020 Basic Fun, Inc., 301 Yamato Road, Suite 4200, Boca Raton FL 33431, USA.
All rights reserved. K'NEX and STEAMagination are registered trademarks and the Basic Fun logo is a trademark of Basic Fun, Inc.
Product & colors may vary. Most models can be built one at a time.

WARNING: CHOKING HAZARD – Toy contains a small ball and small parts.
Not for children under 3 years.

Mega Motorcycle
15149*



*Sold separately

10 Model
15216*

