

CHAINSAW

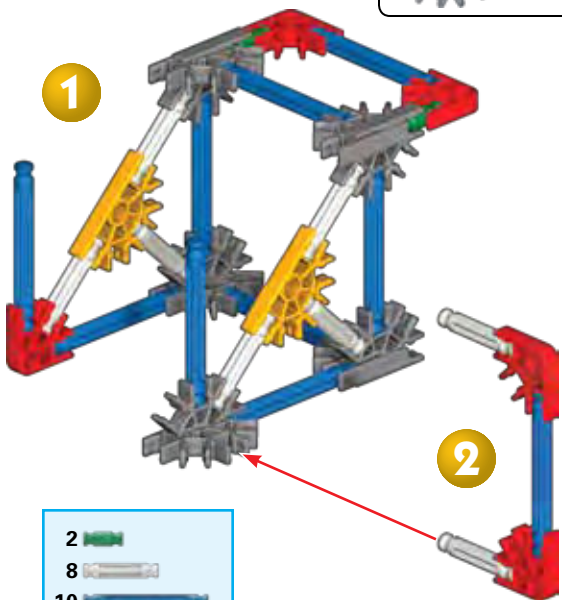

- 2
- 8
- 10
- 5
- 2
- 10

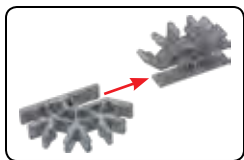
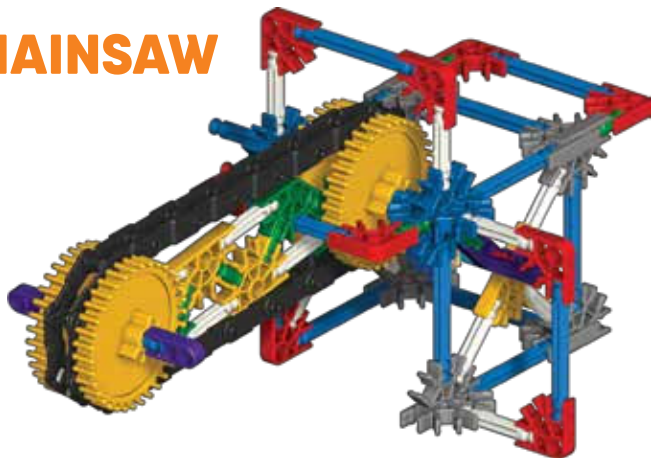
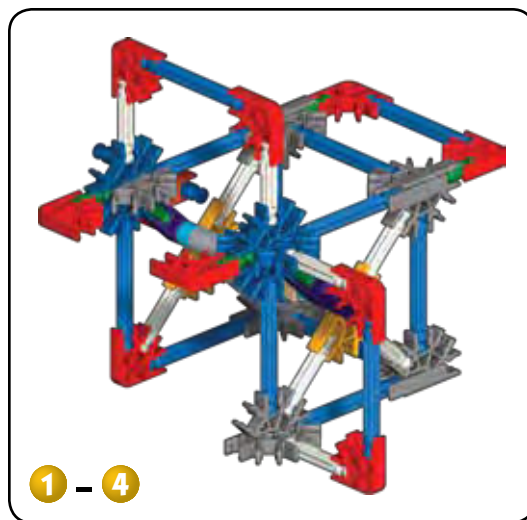
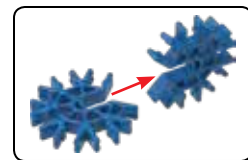
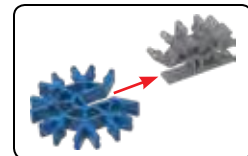
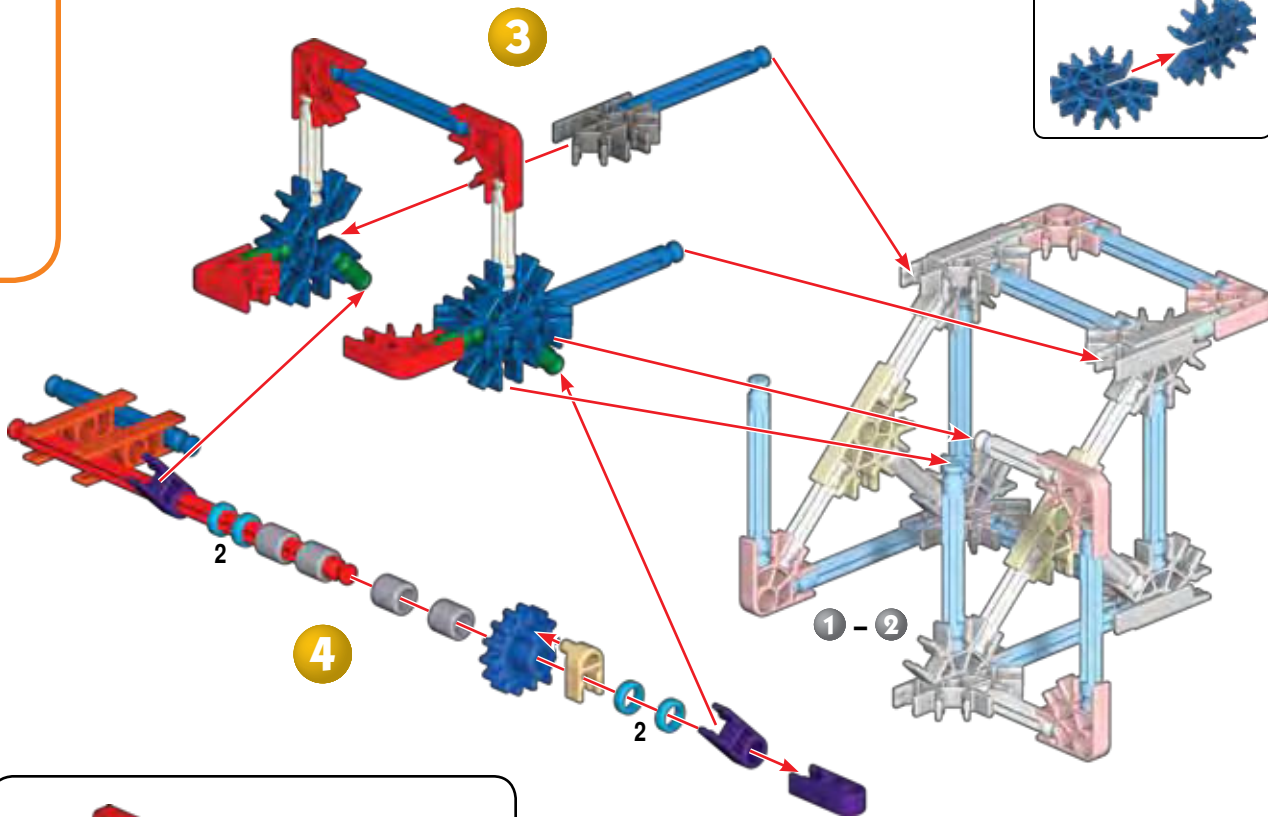

- 4
- 4
- 1
- 4
- 4
- 1
- 2
- 3
- 2
- 4
- 1
- 1
- 3

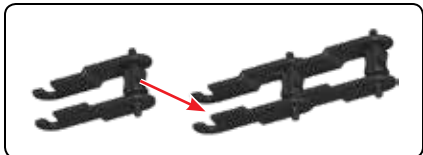
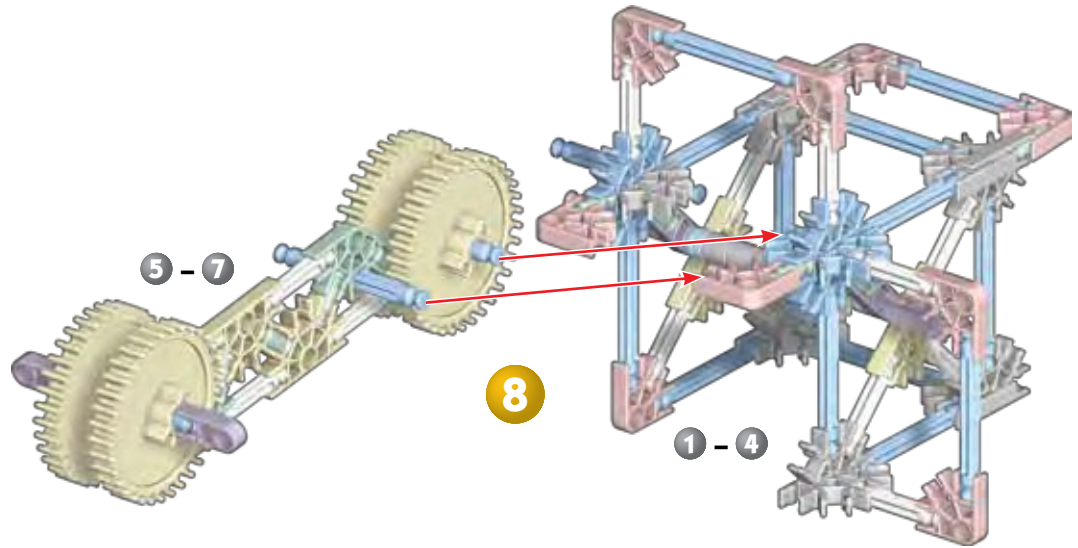
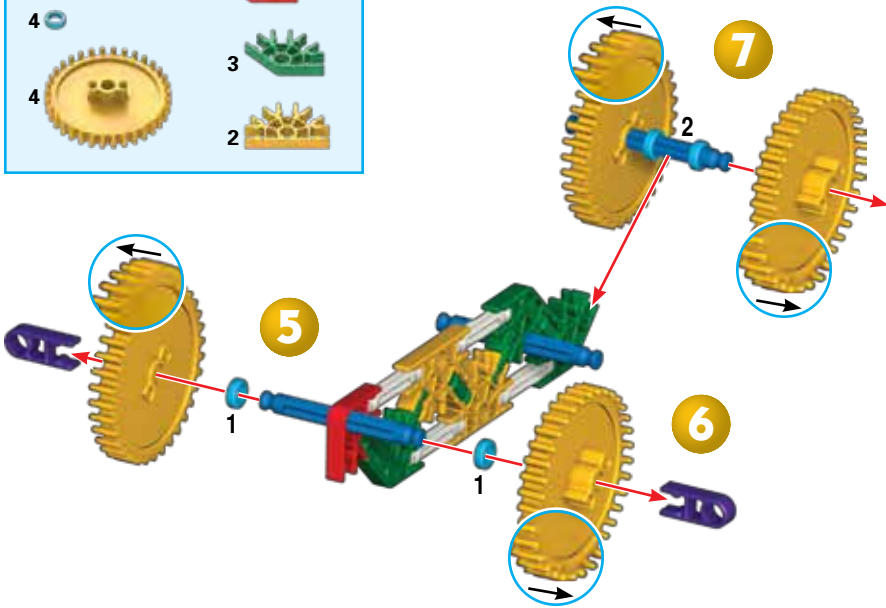
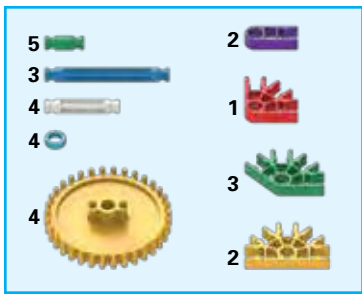

IMPORTANT: Attach all the chain links in the same direction.

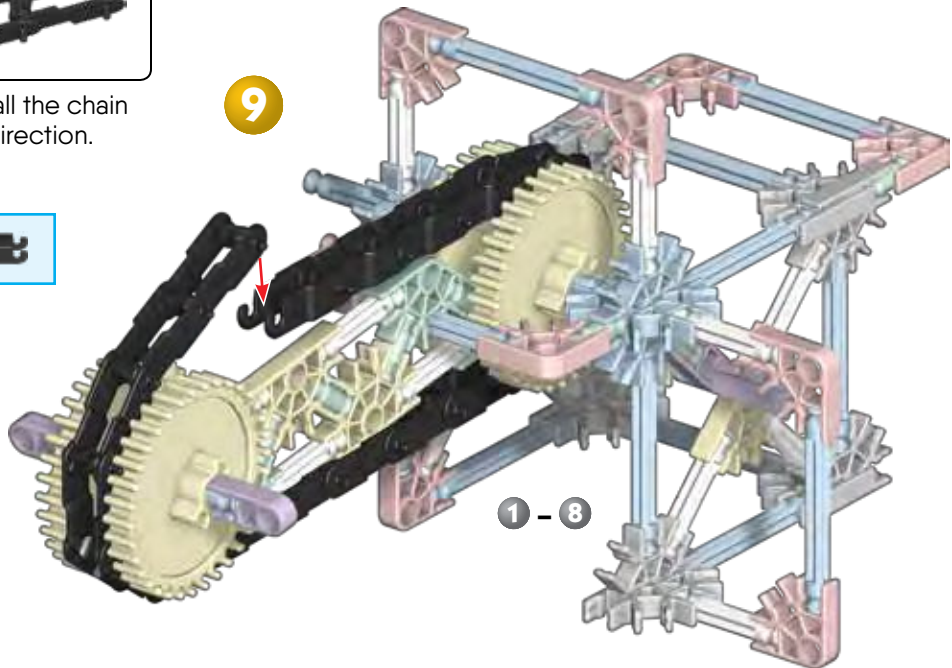

CHAINSAW

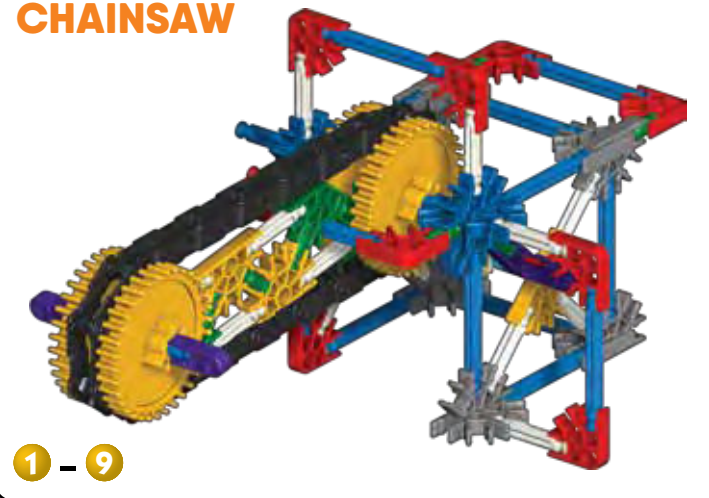

PHONOGRAPH

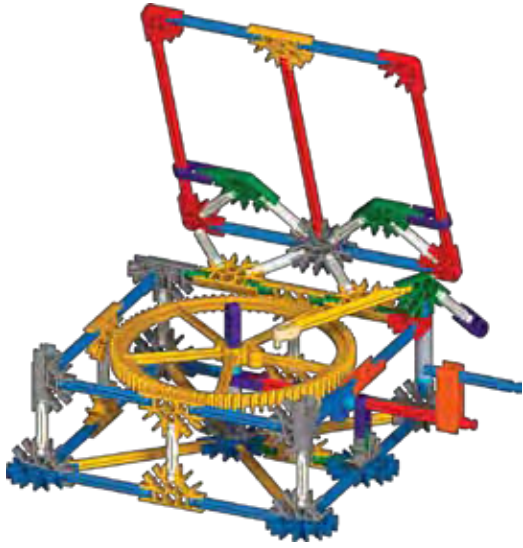

- | | | | | | |
|----|--|----|--|---|--|
| 8 | | 1 | | 3 | |
| 10 | | 13 | | | |
| 4 | | | | | |
| 1 | | 14 | | | |
| 9 | | 4 | | | |

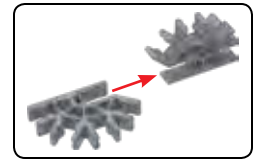
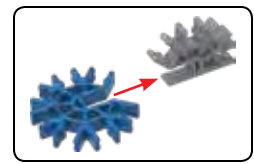
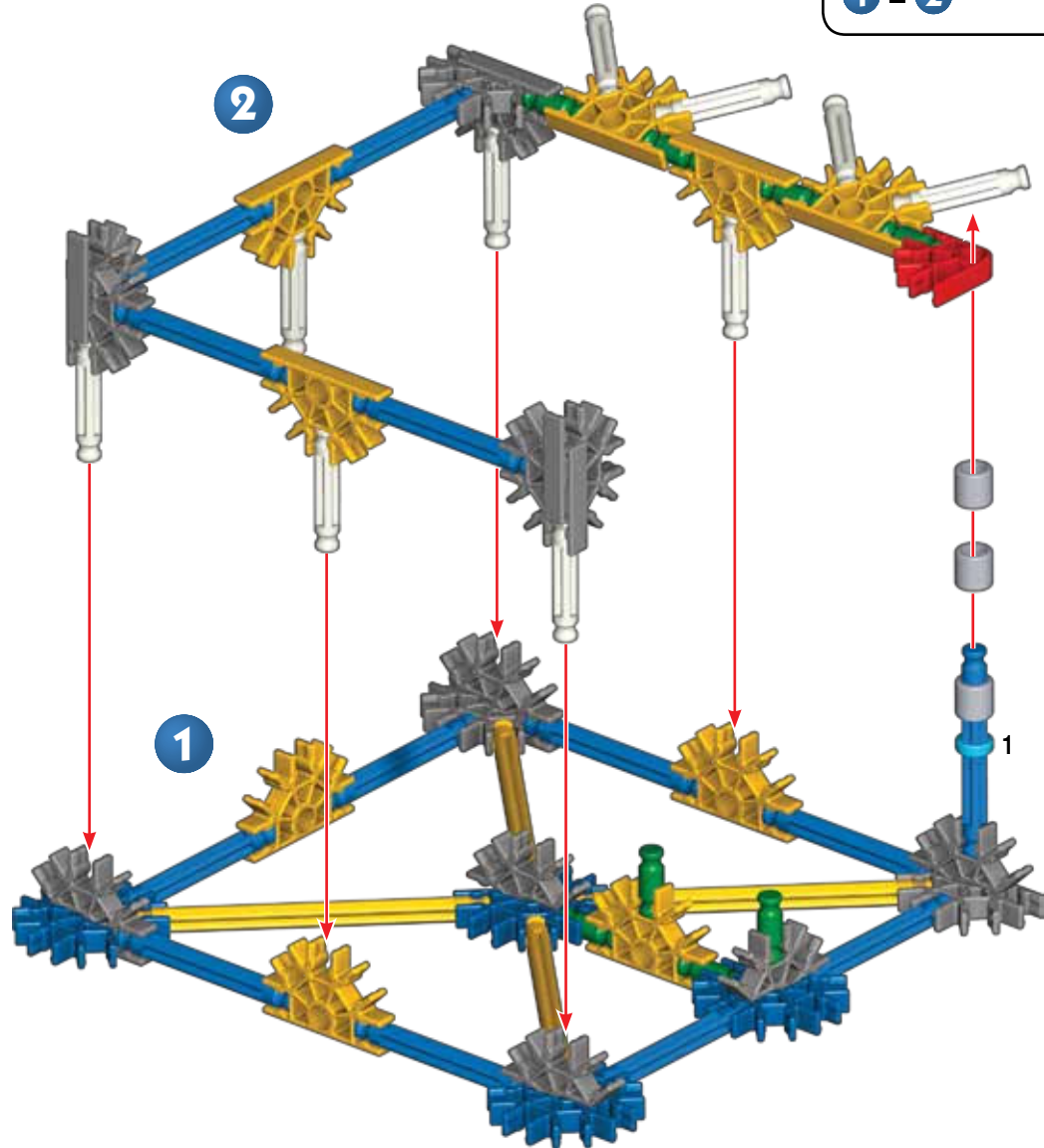
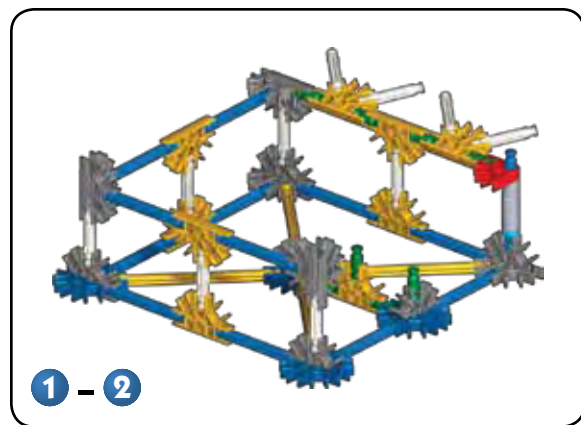

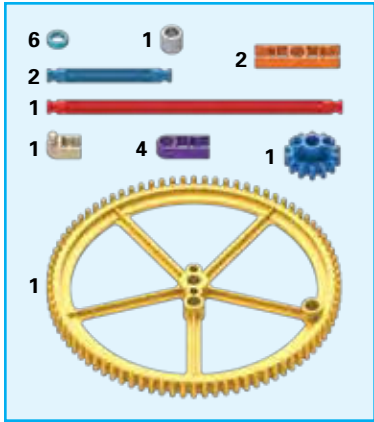

4

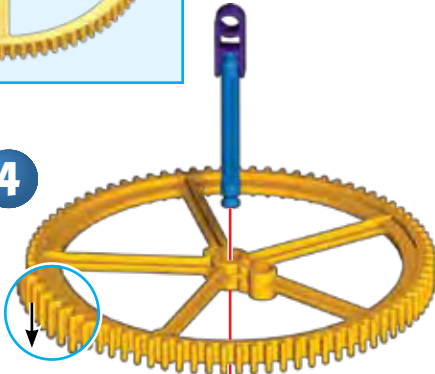

Make sure the two gears mesh.

3

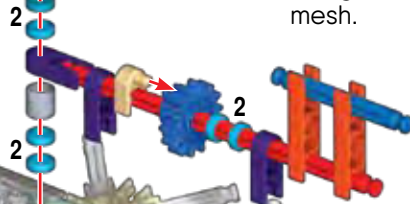
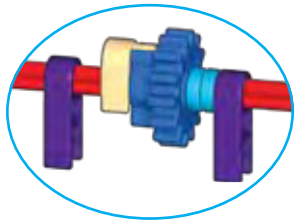

1 - 2

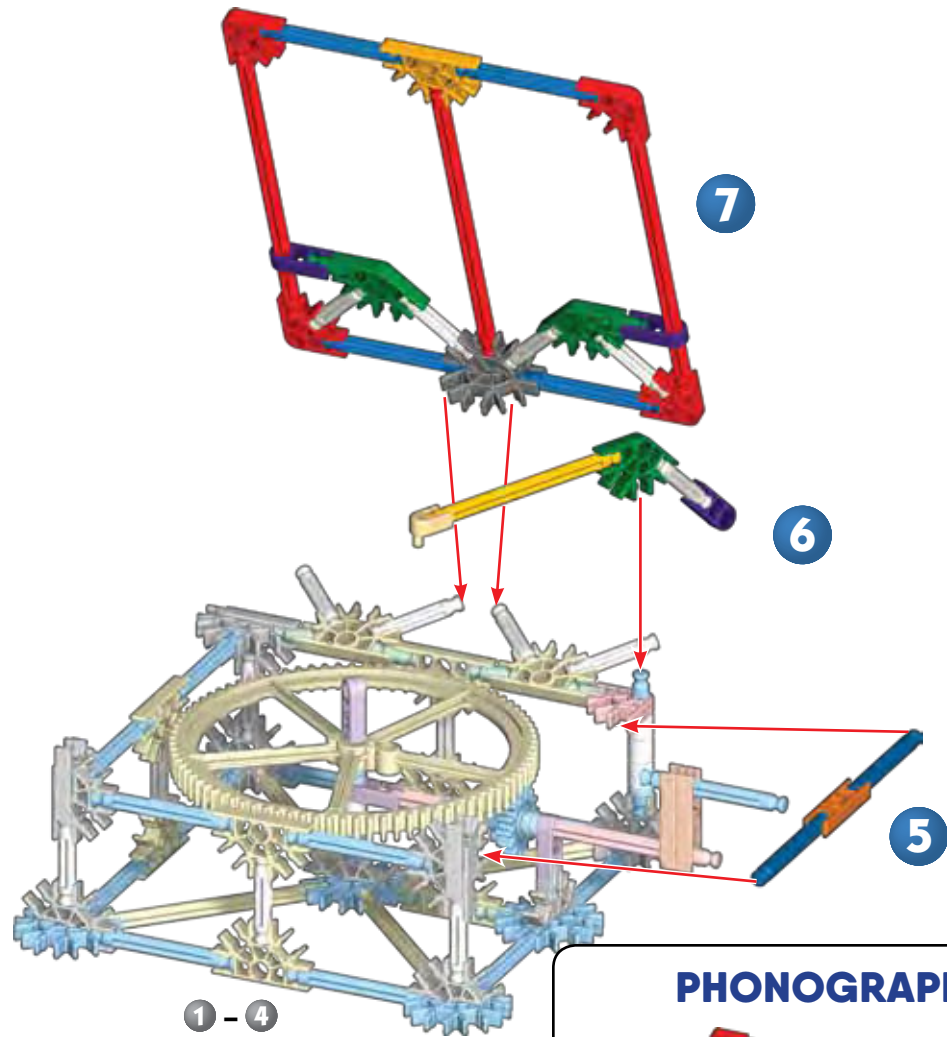
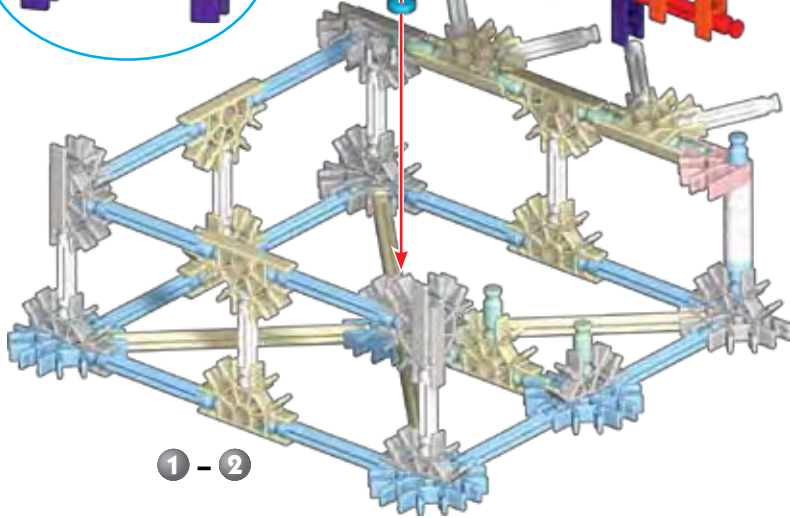

7

6

5

1 - 4

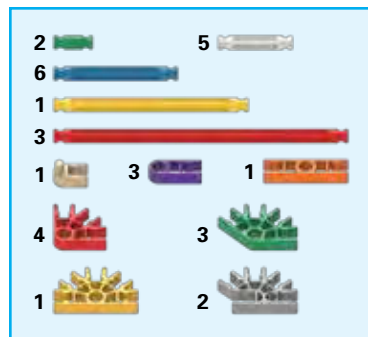

PHONOGRAPH



1 - 7

STATIONARY BIKE

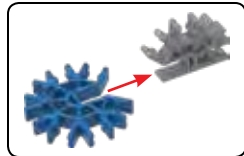
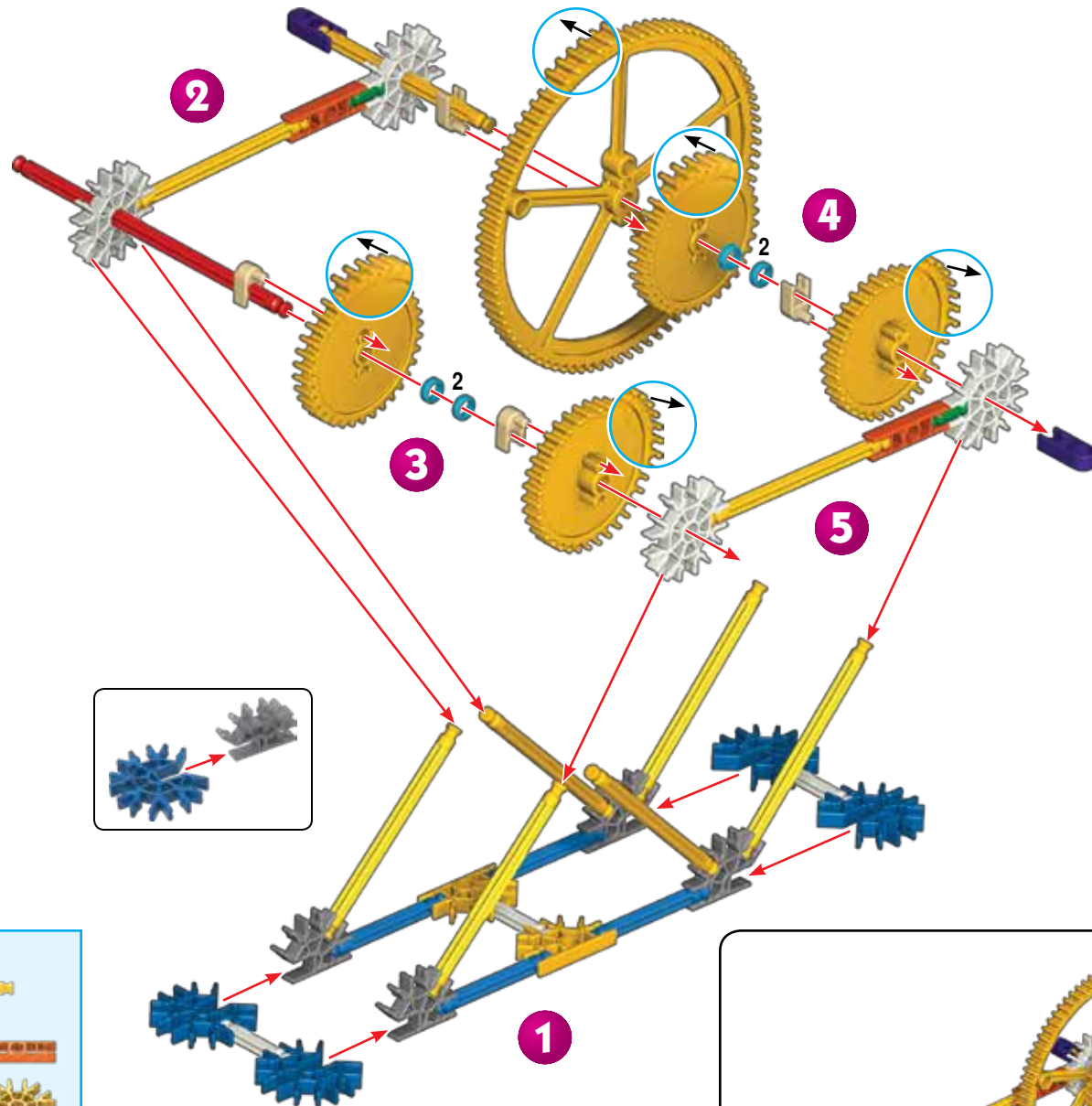

- | | | | |
|---|---|---|--|
| 2 | 3 | | |
| 4 | 9 | | |
| 1 | | | |
| 4 | | 2 | |
| 4 | 4 | 2 | |
| 2 | | 4 | |
| | | 4 | |
| | | 4 | |
| | | 4 | |
| | | | |

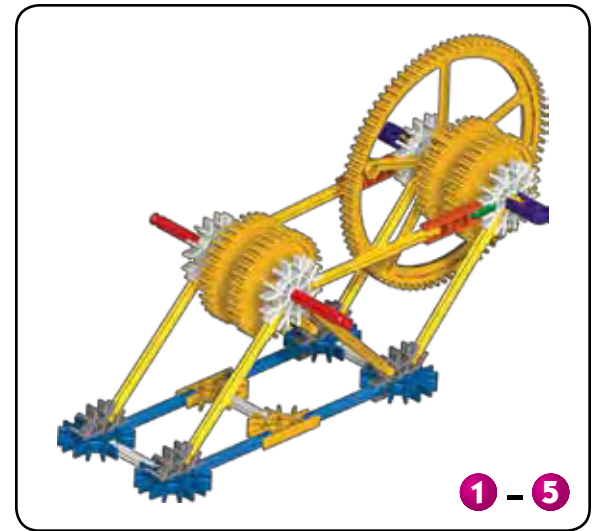

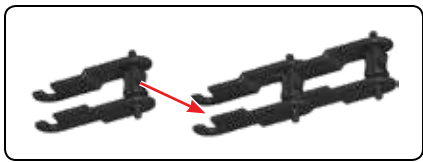

IMPORTANT: Attach all the chain links in the same direction.

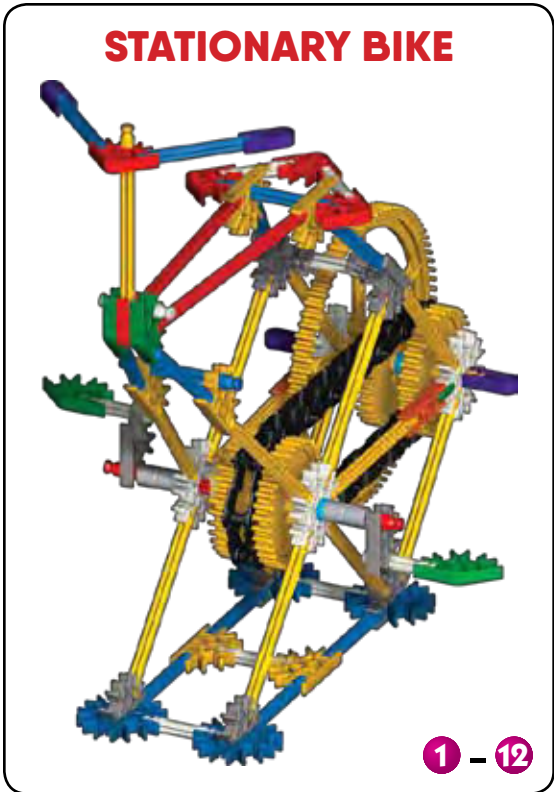
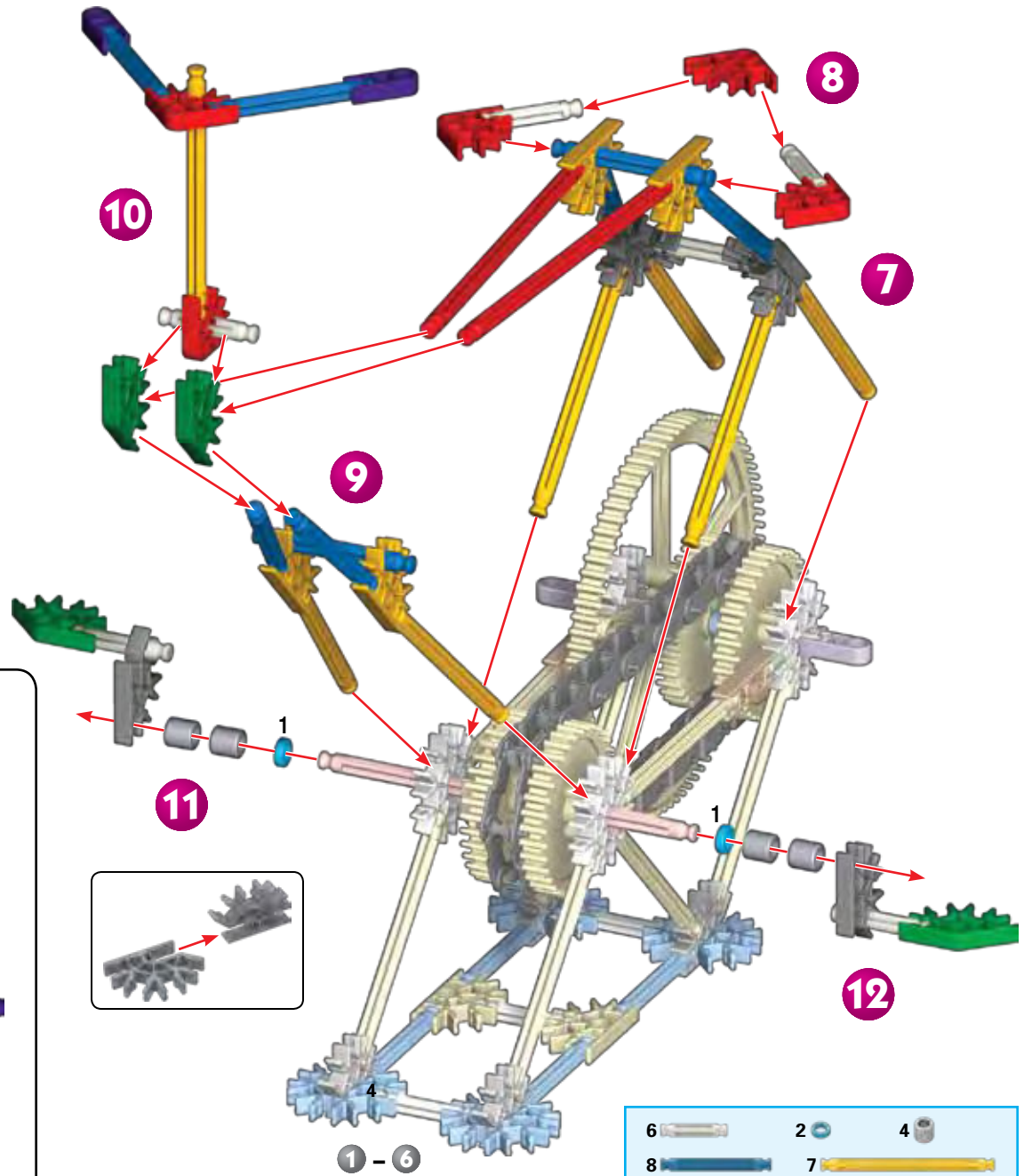
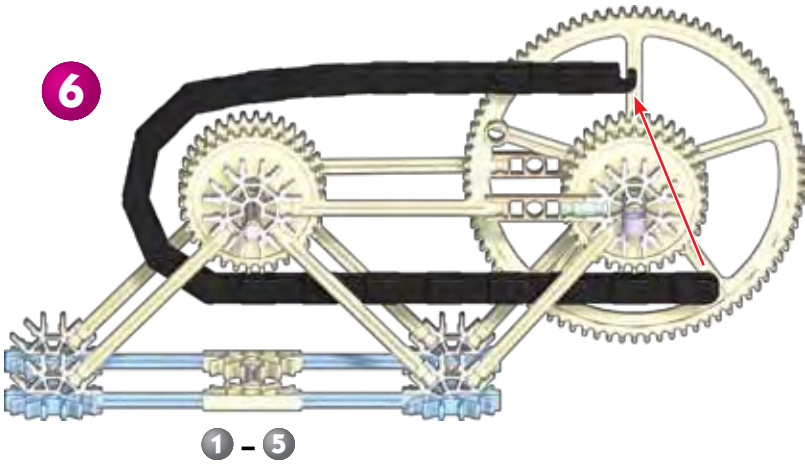

6		2		4	
8		7			
2					
2		5		4	
4		6			

EGGBEATER

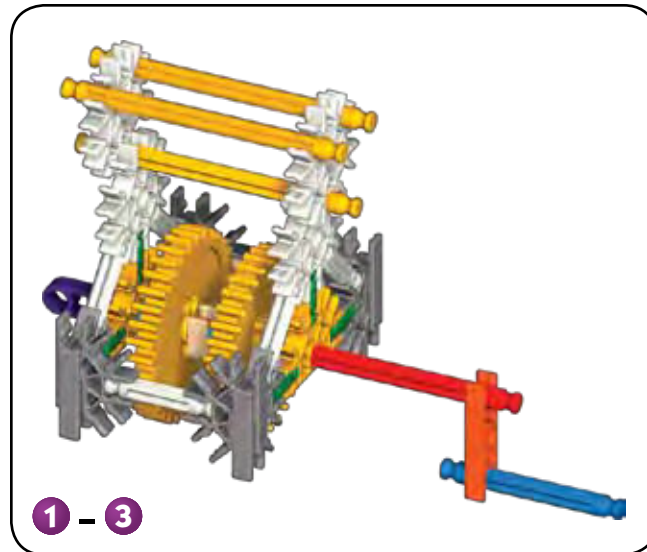
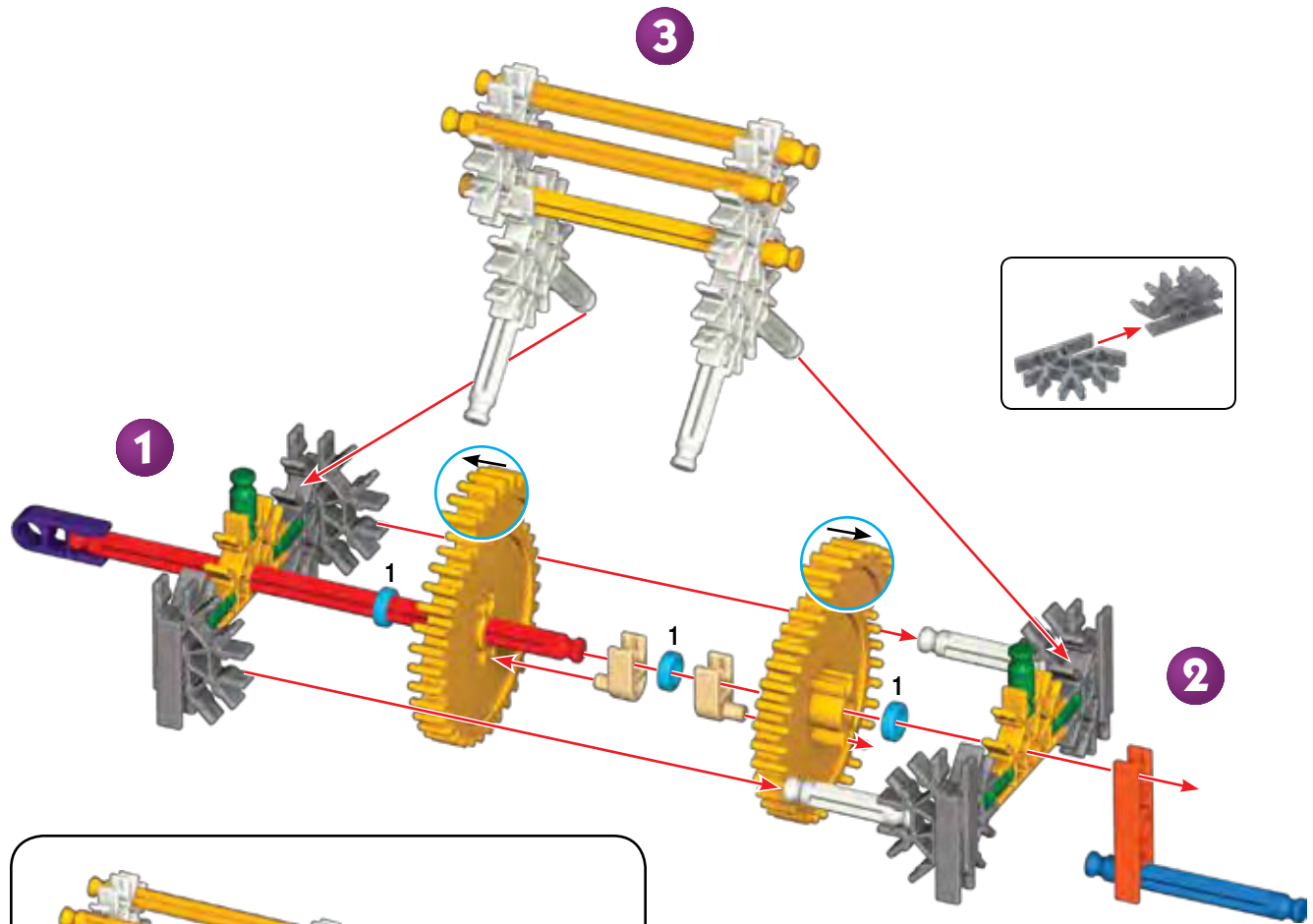
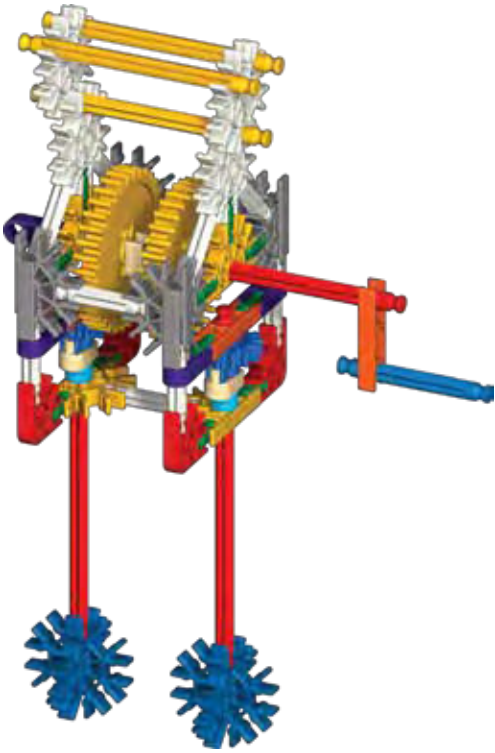

6	3
1	6
1	1
3	2
1	4
2	2
8	

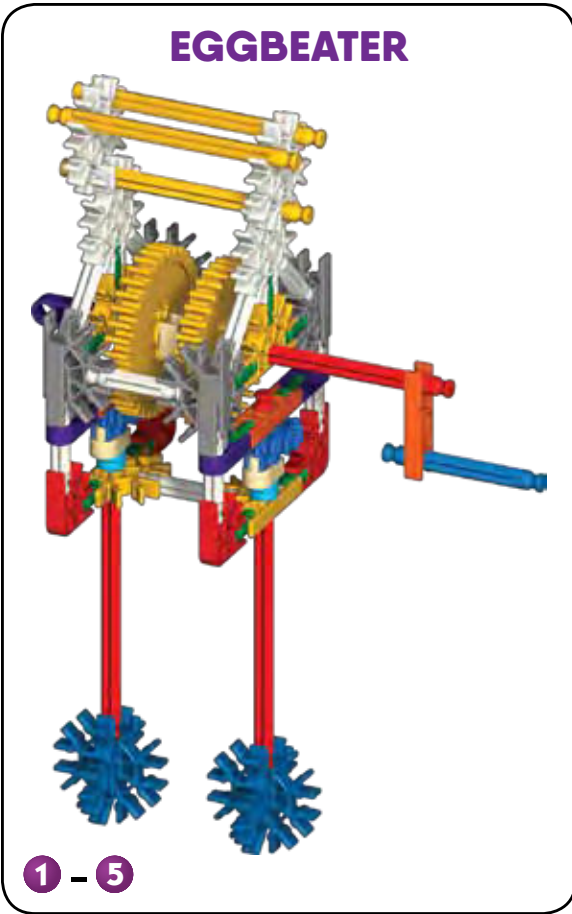
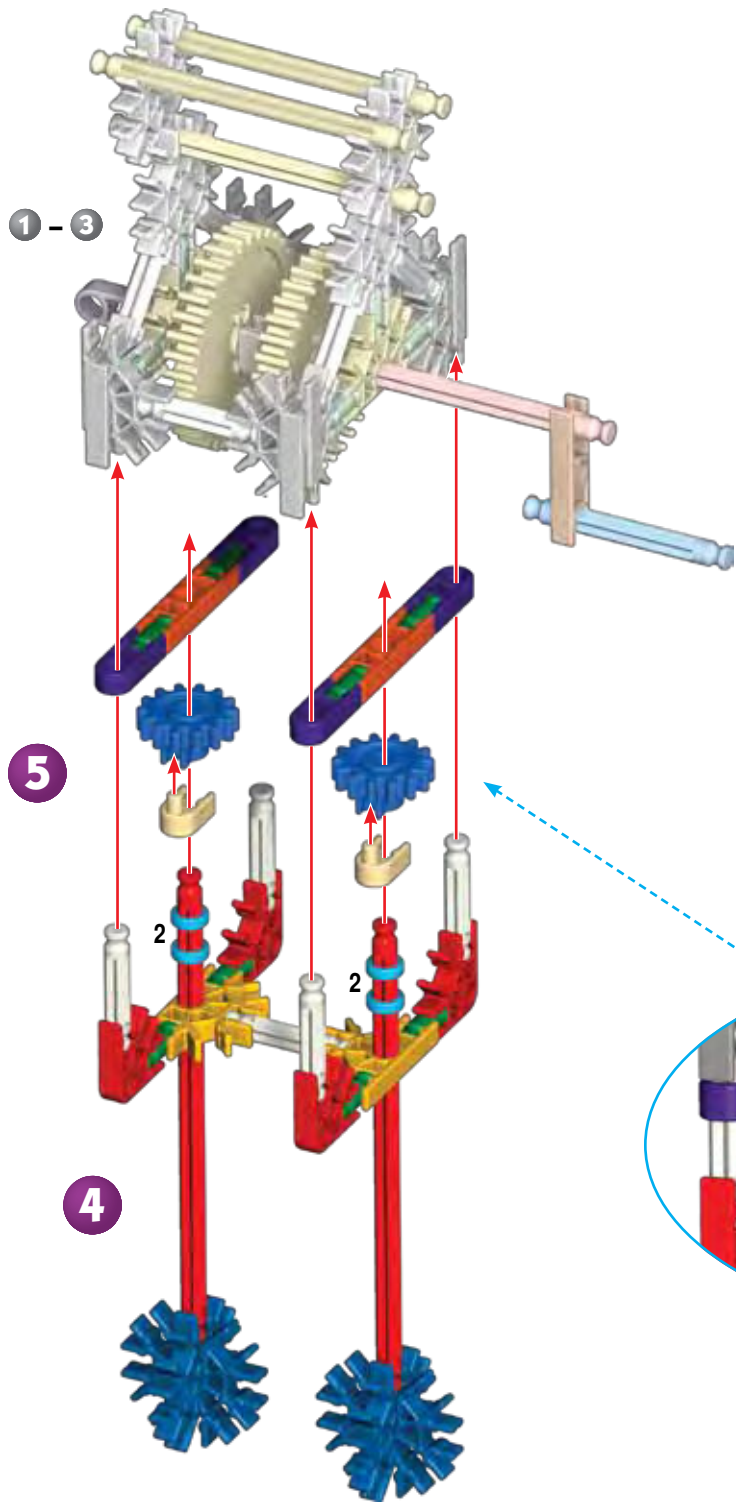

- | | |
|---|---|
| 8 | 4 |
| 2 | 2 |
| 4 | 2 |
| 2 | 2 |
| 4 | 2 |
| 2 | 4 |

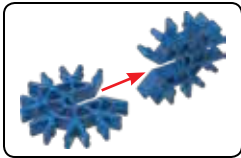

Make sure the two gears mesh.