

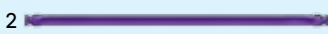



- 2 
- 6 
- 1  9  3 







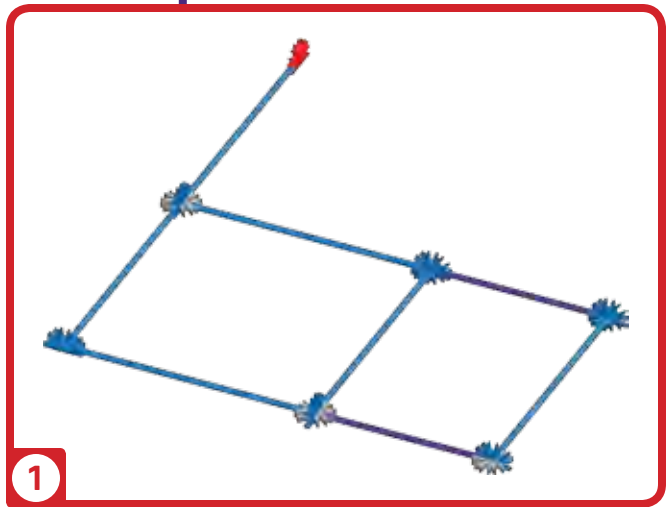
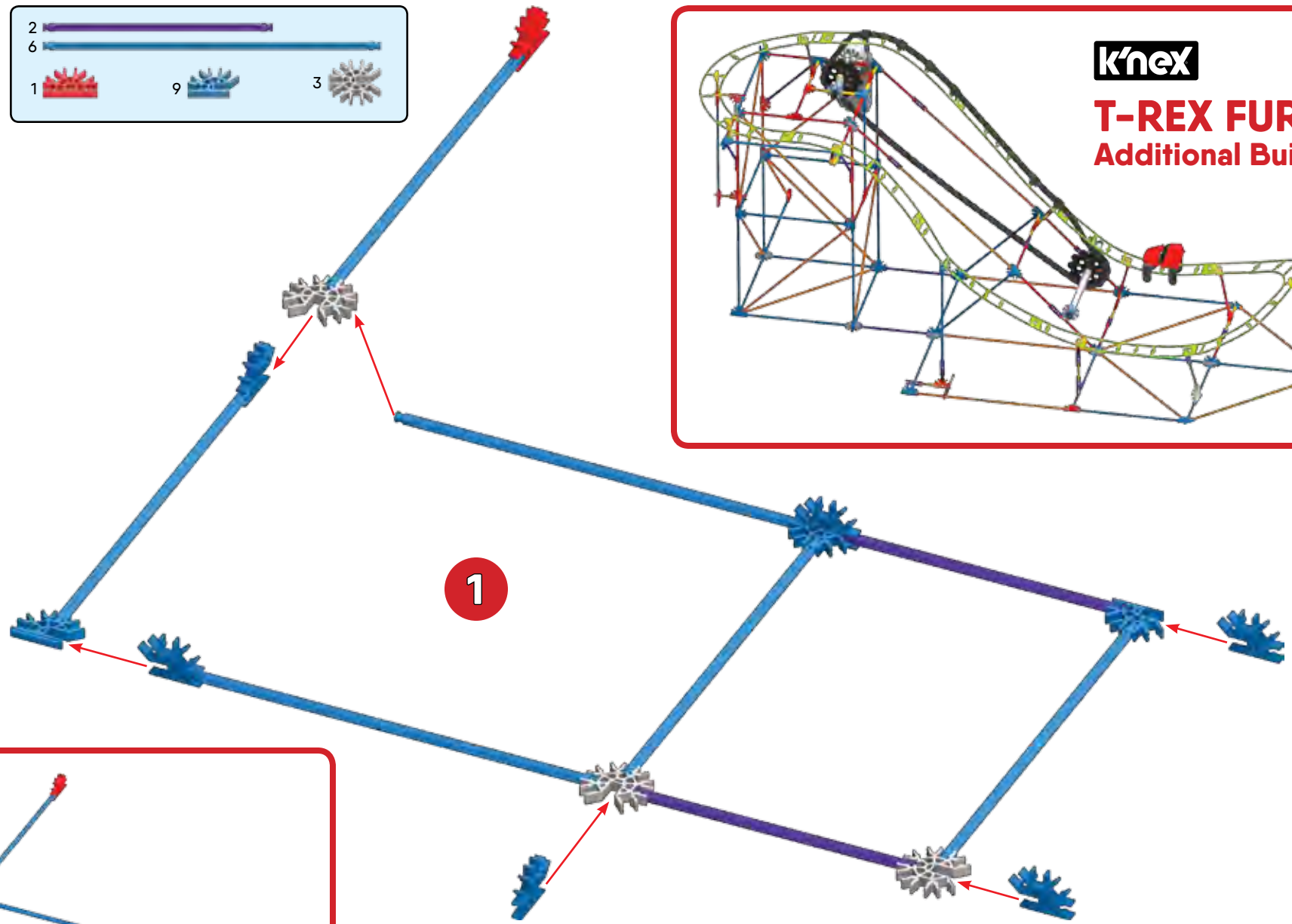
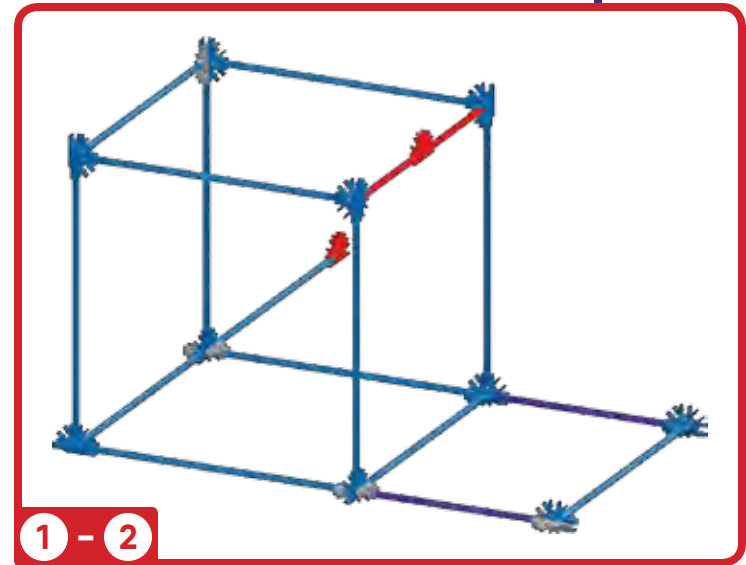
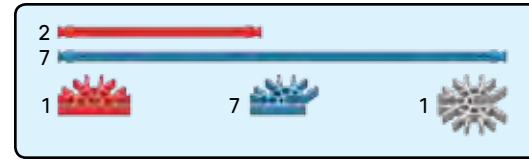
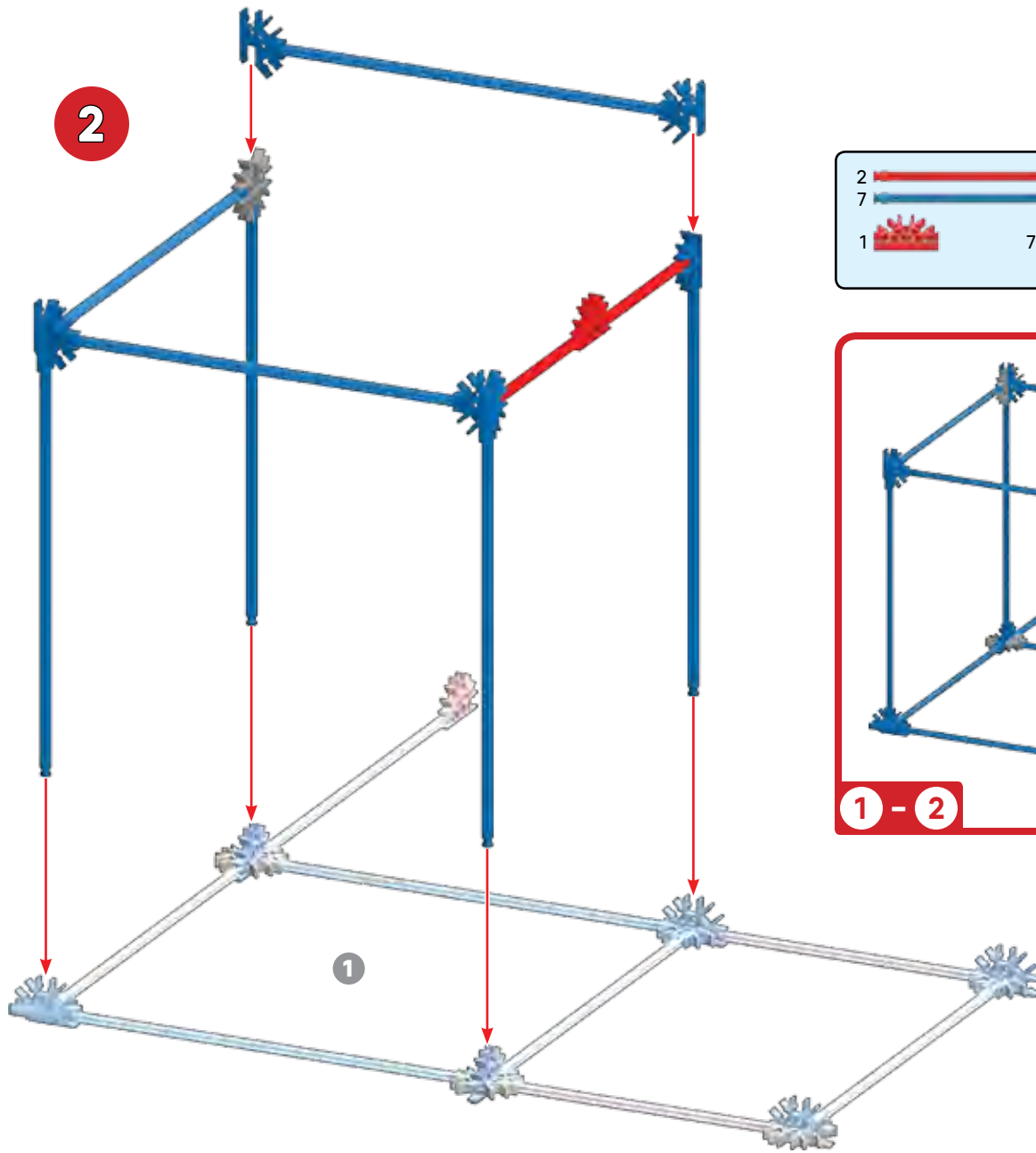
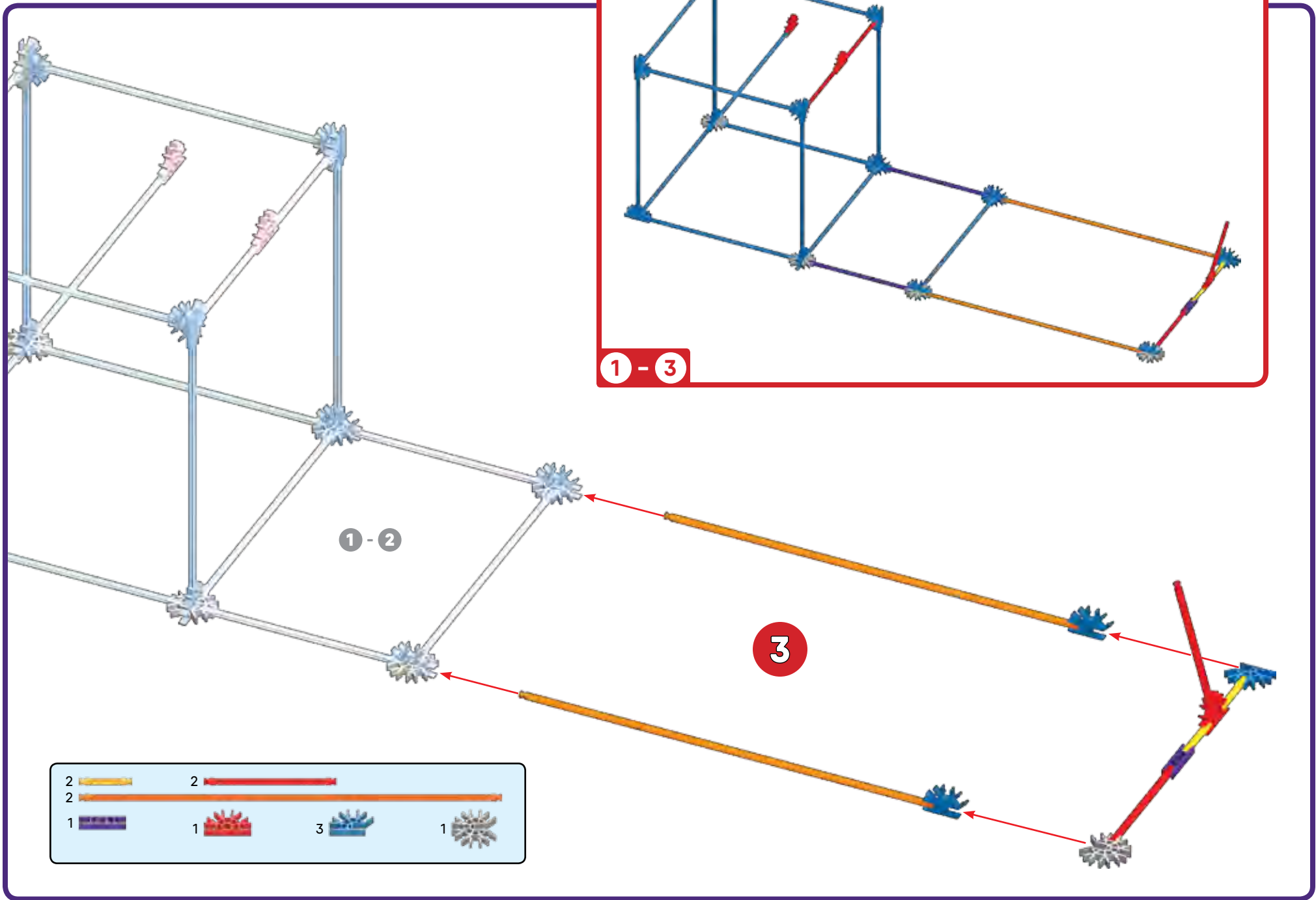
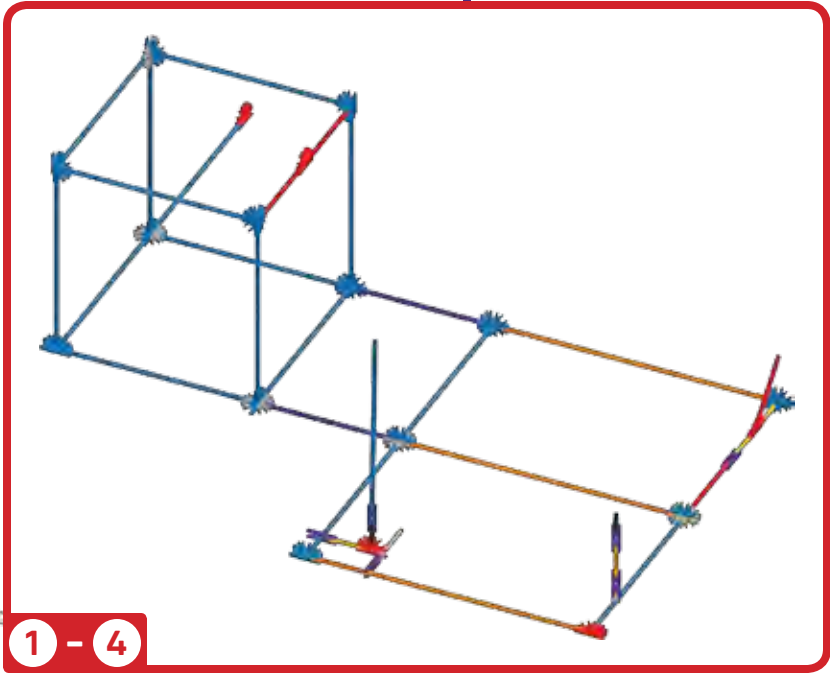
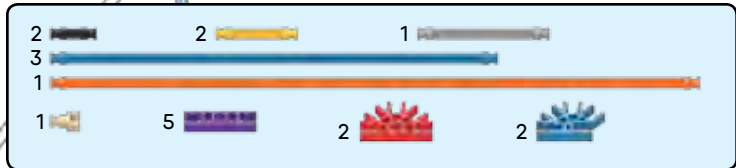

1 - 4

1 - 3

4

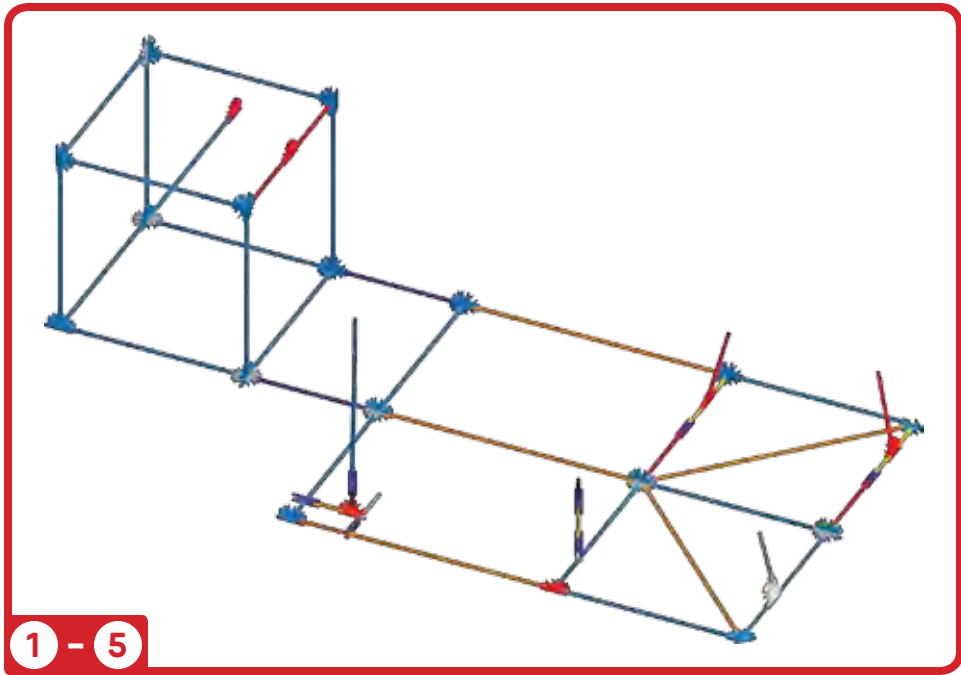

1 - 5

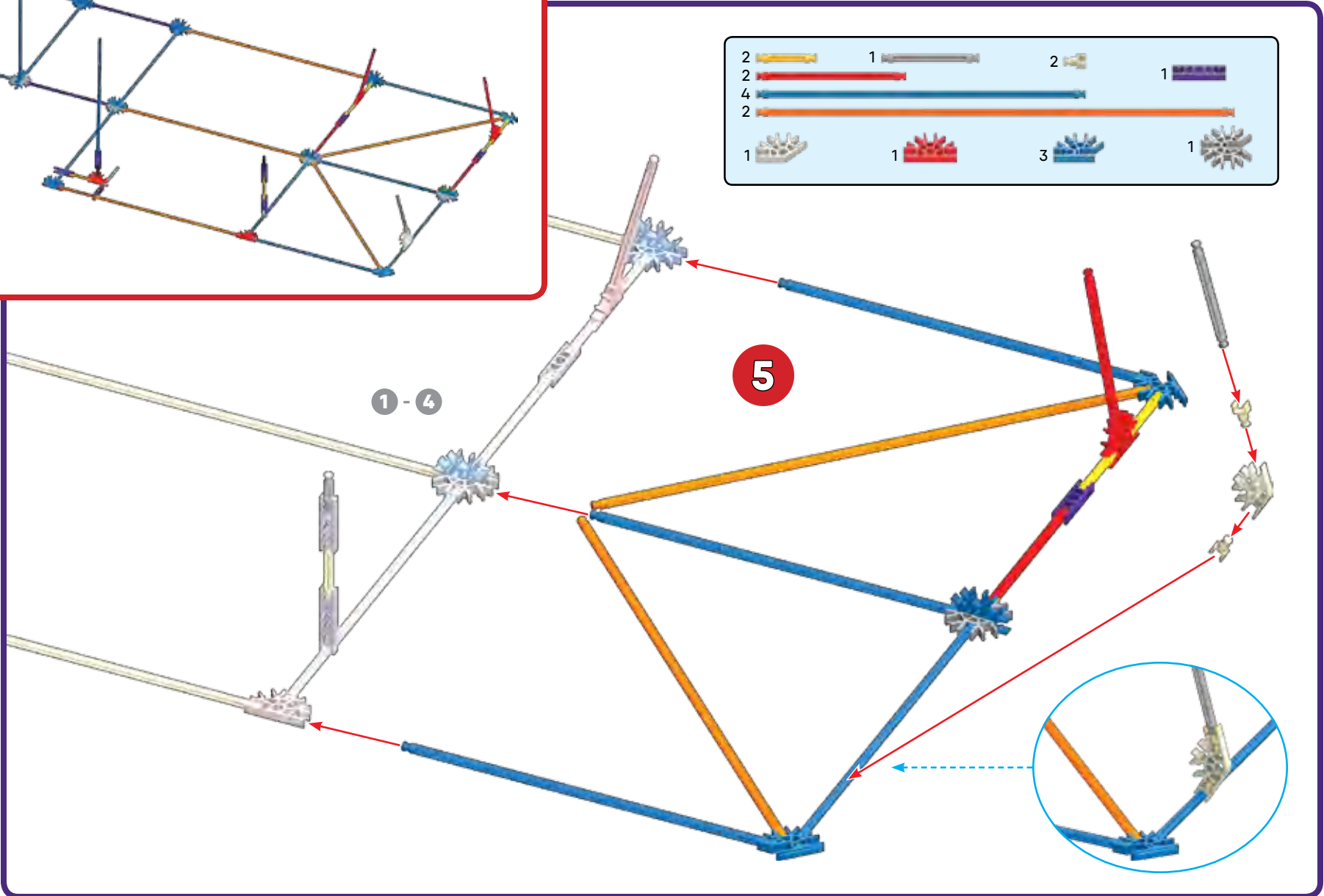

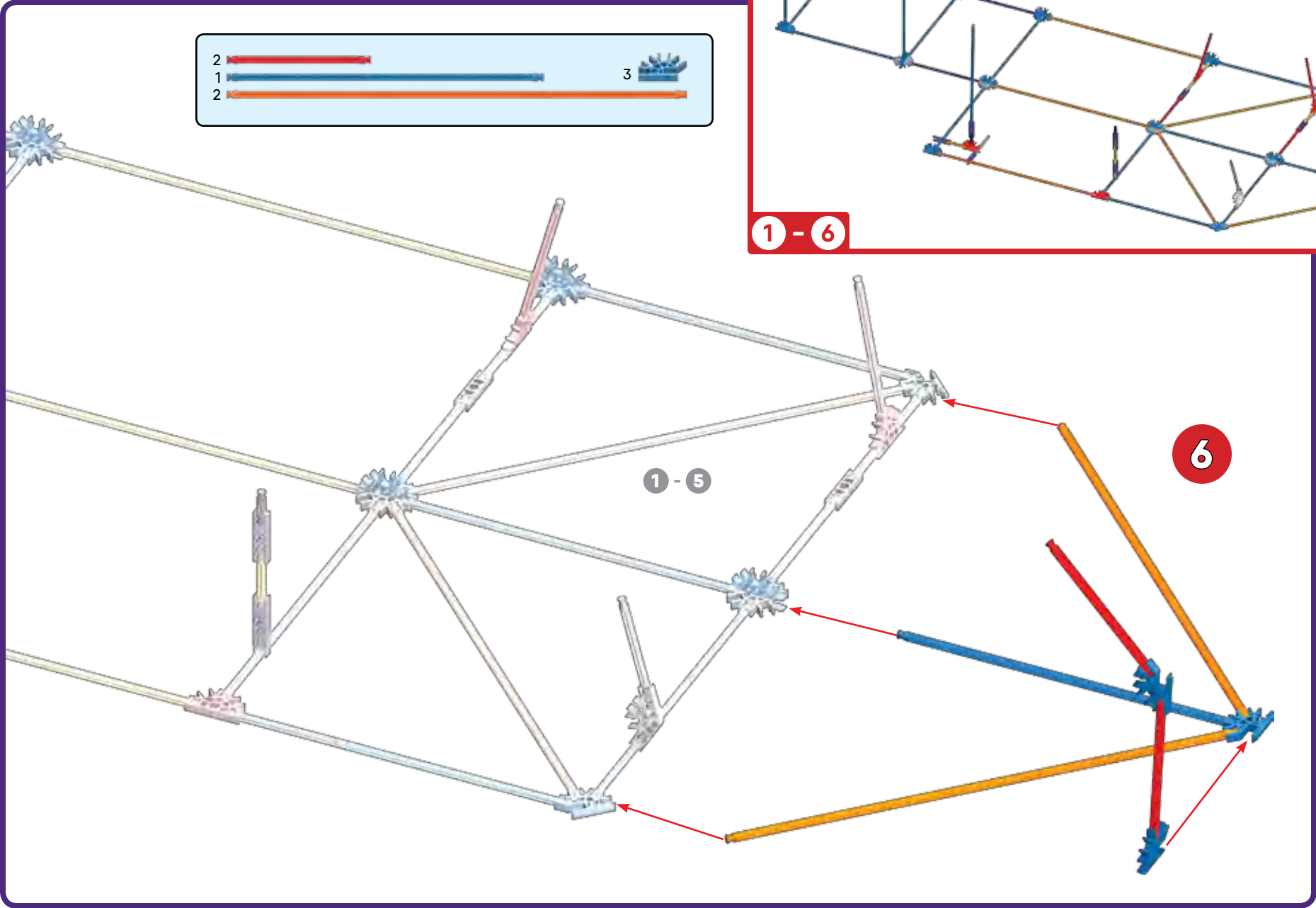
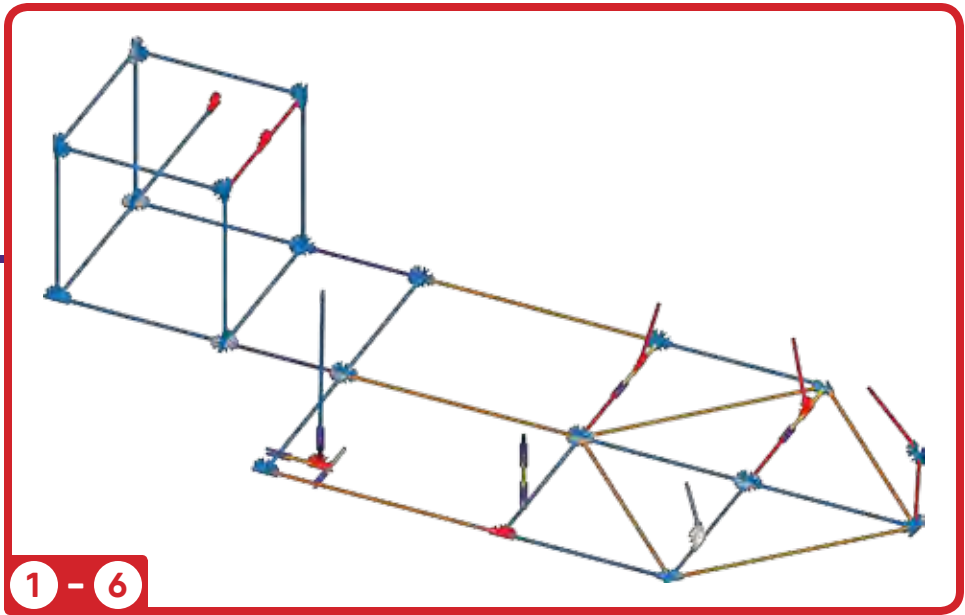

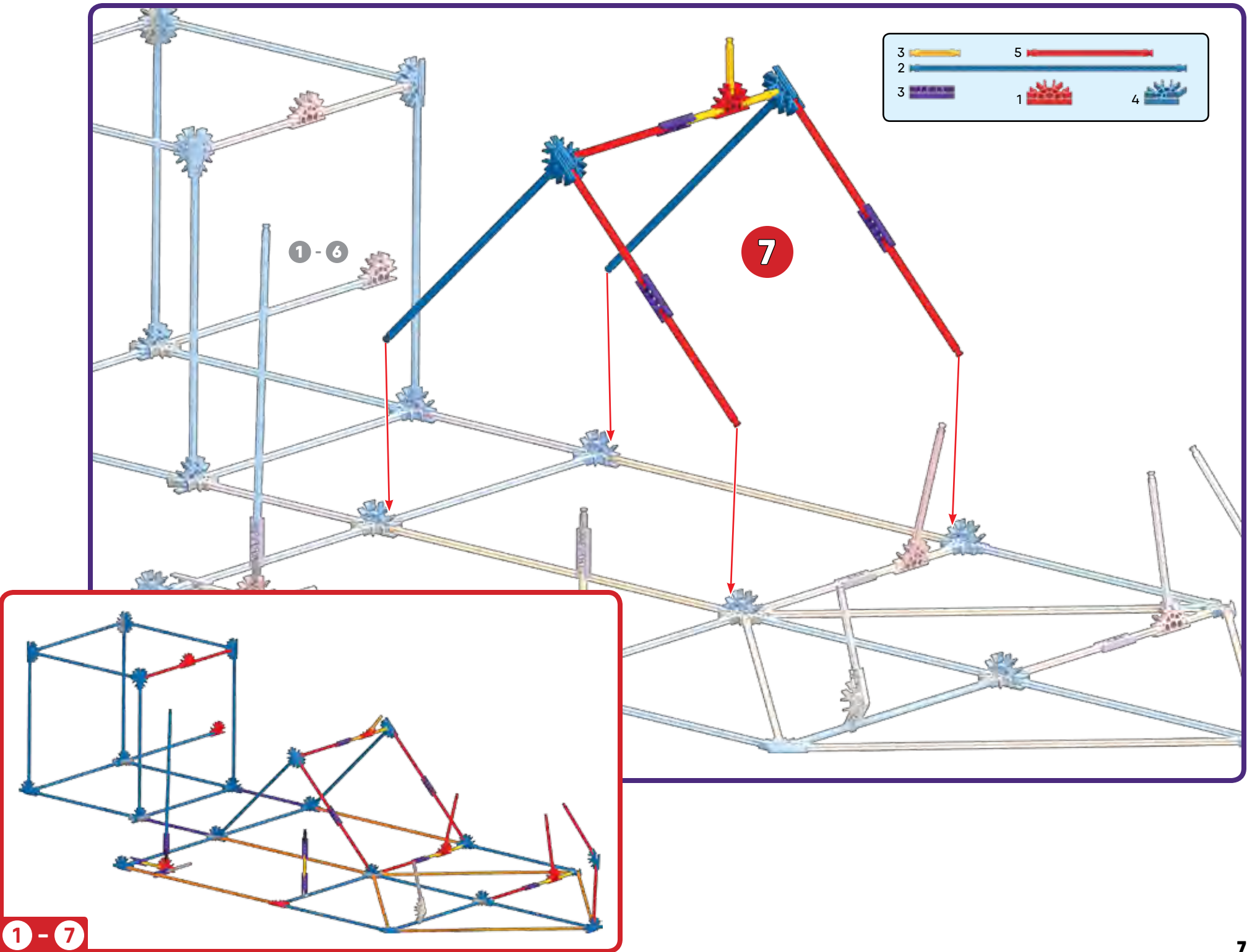

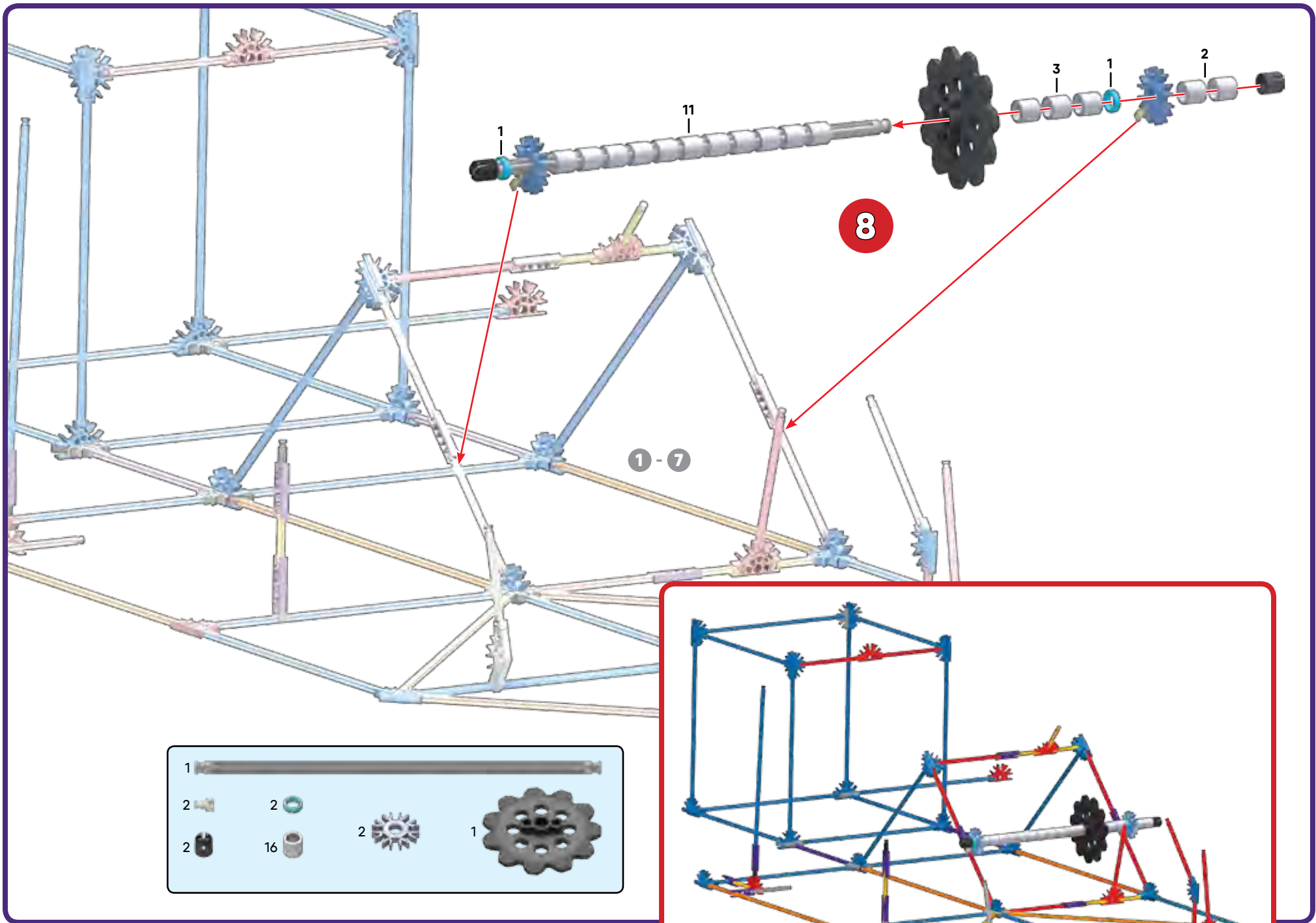

- | | | | |
|---|----|---|---|
| 1 | | | |
| 2 | 2 | | |
| 2 | 16 | 2 | 1 |

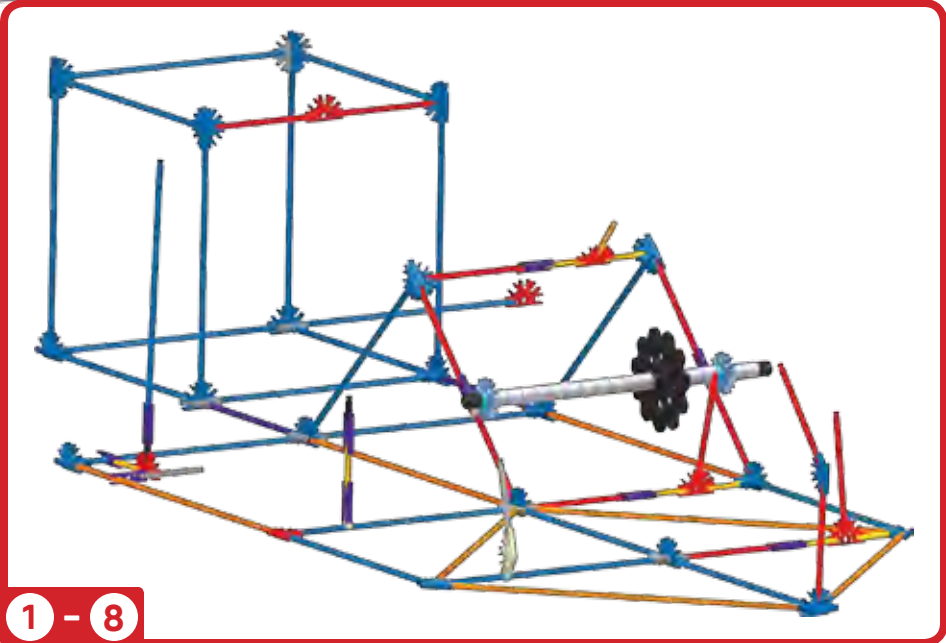

9

6		1	
2			
11			
1			
3			
7		10	
		2	

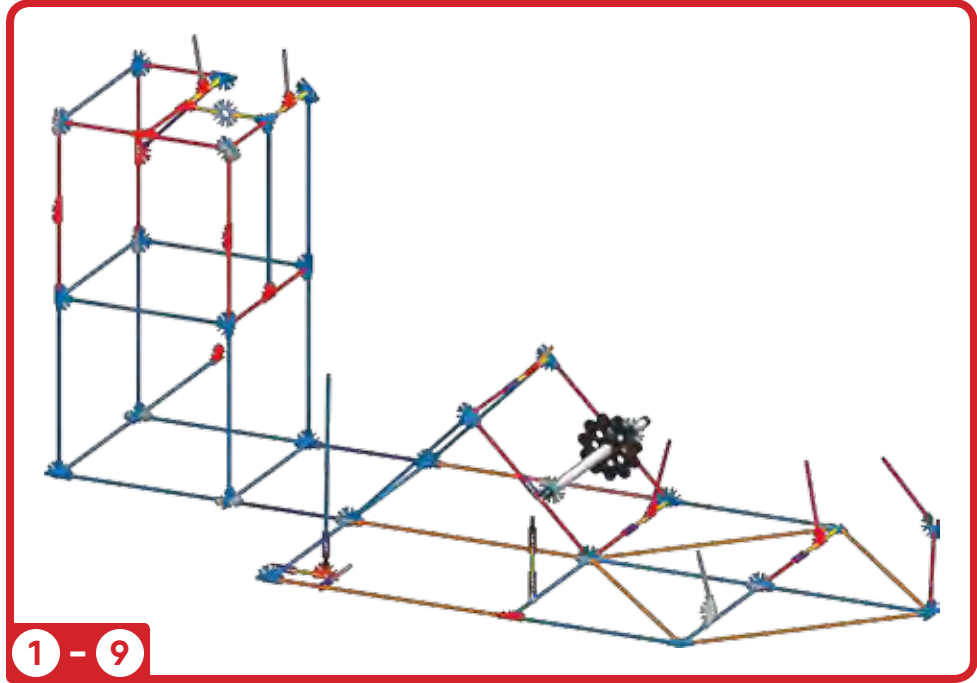
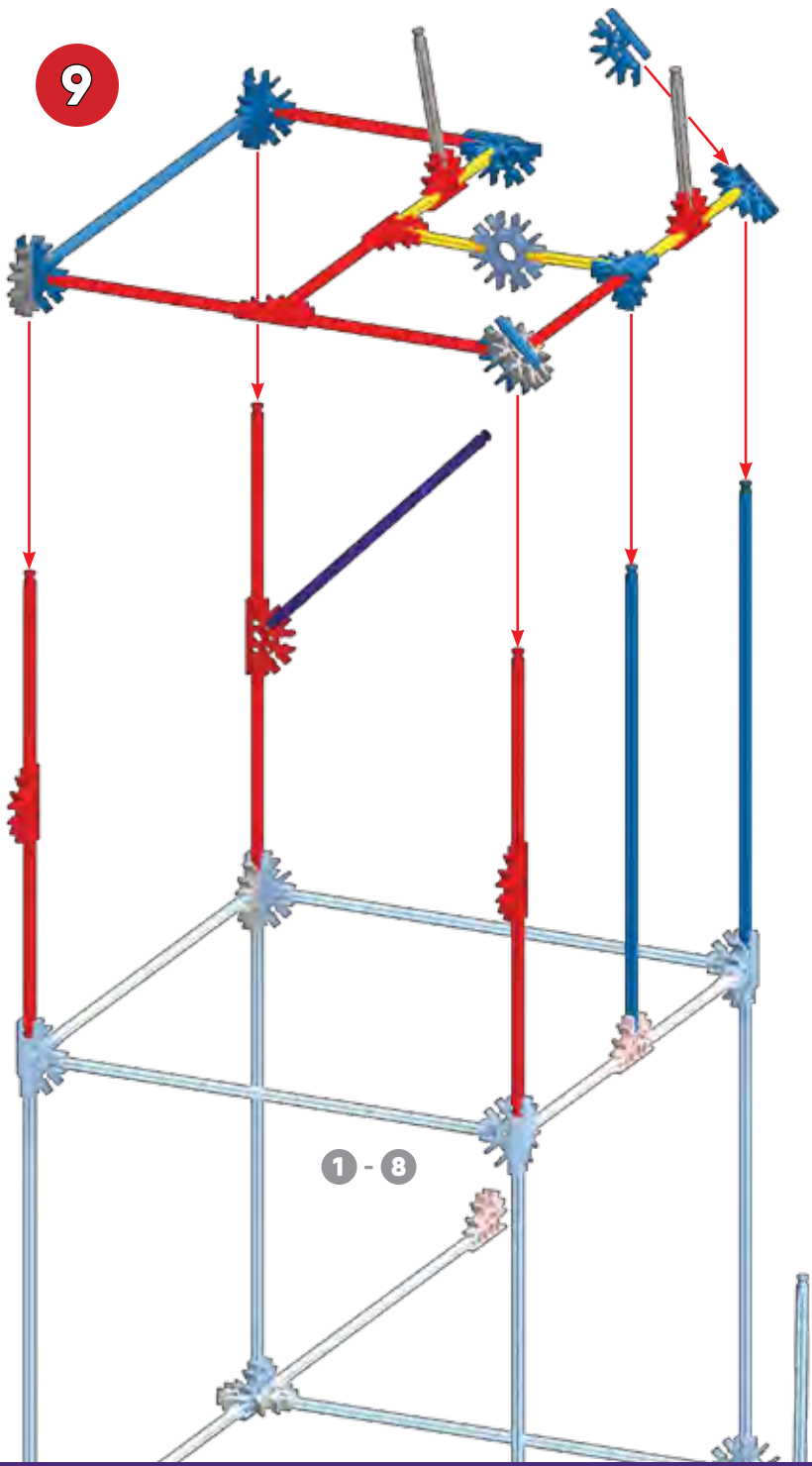

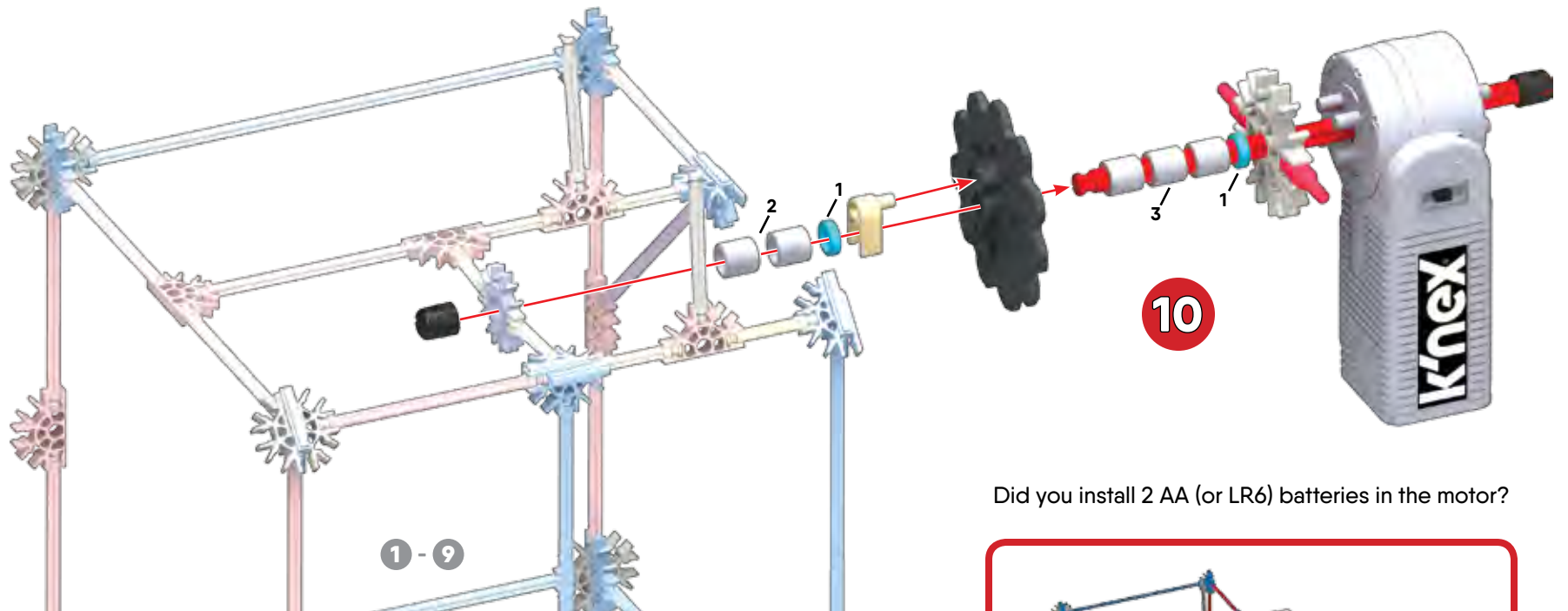

Did you install 2 AA (or LR6) batteries in the motor?

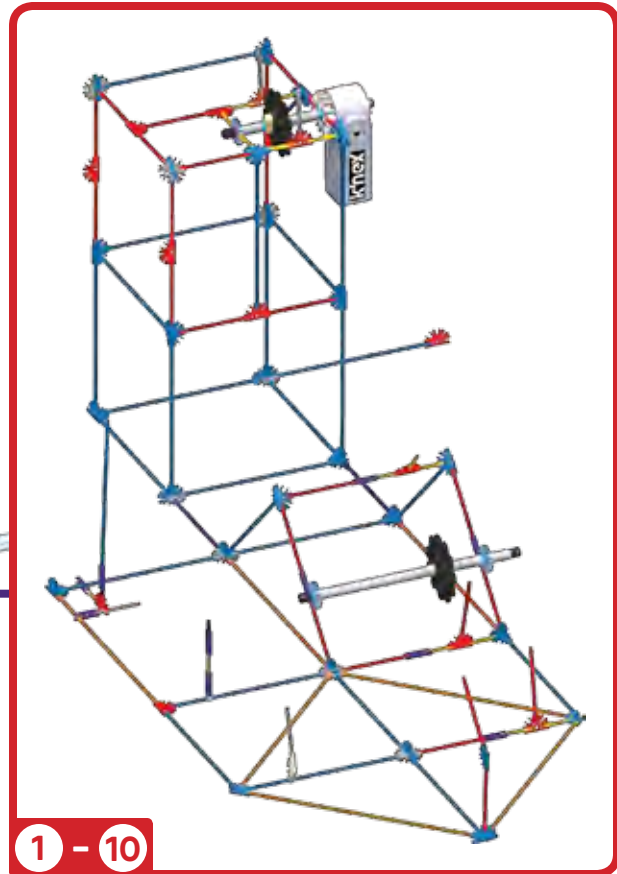

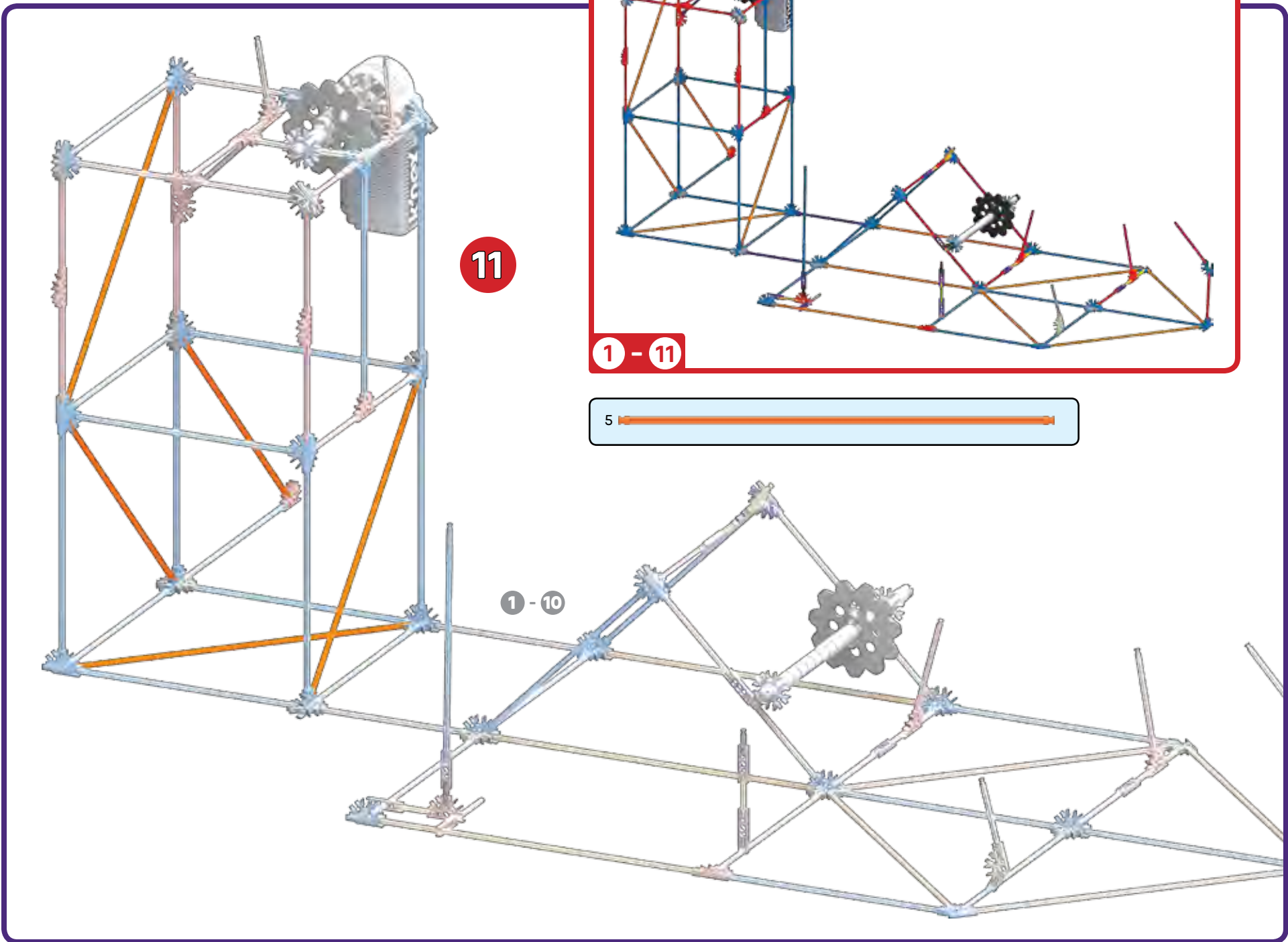

11

1 - 11

5

1 - 10

2  2 
 6 

1 - 12

12

1 - 11

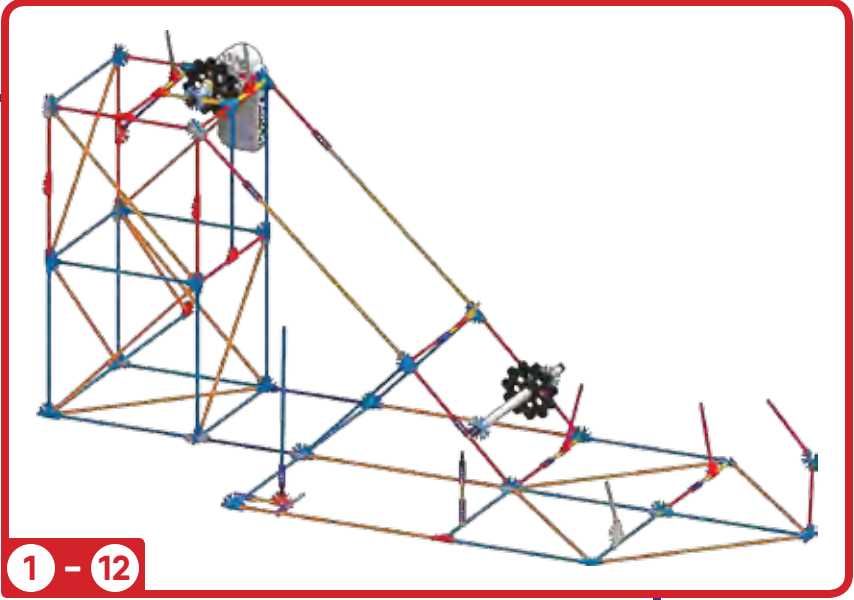
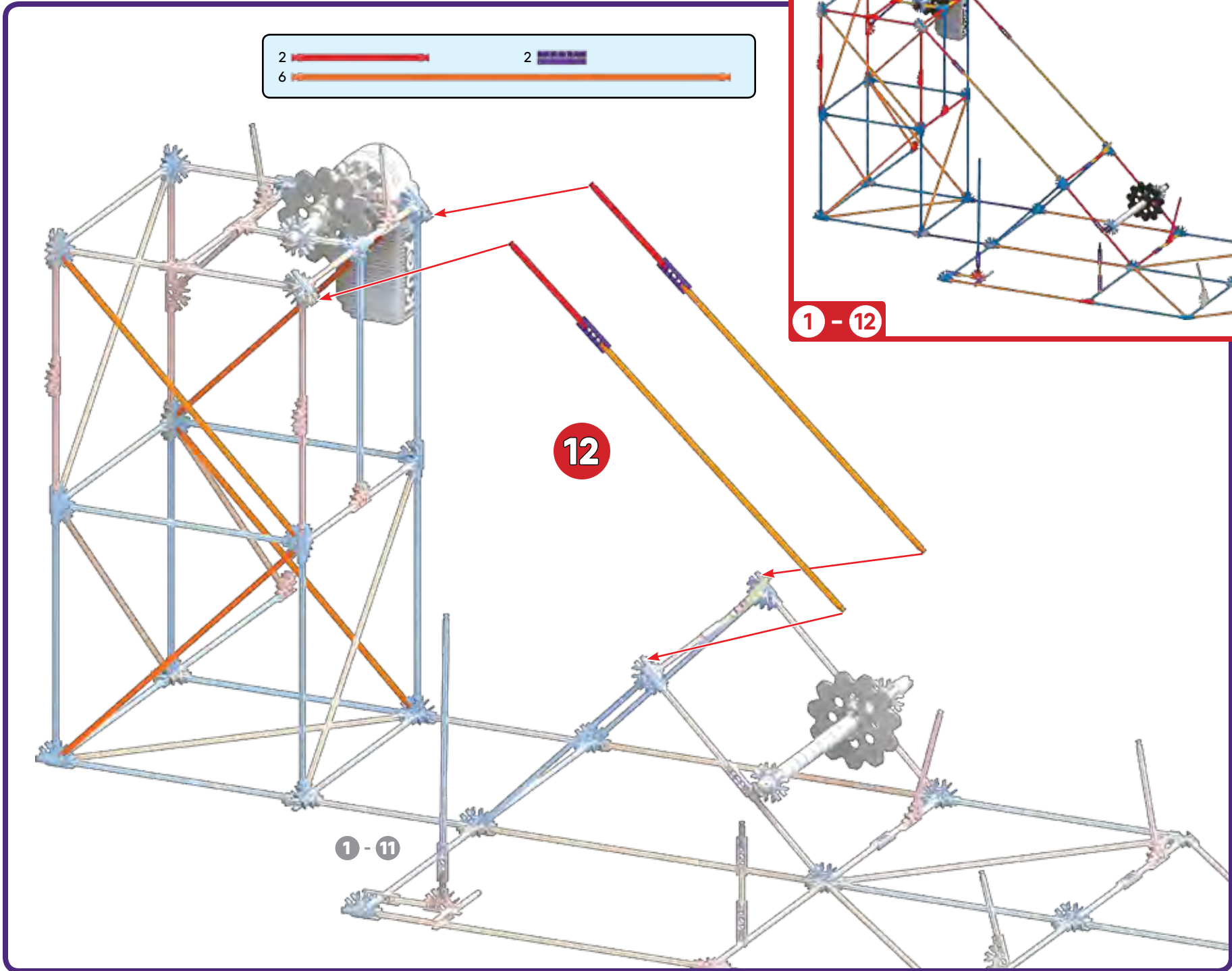

13



1 - 12

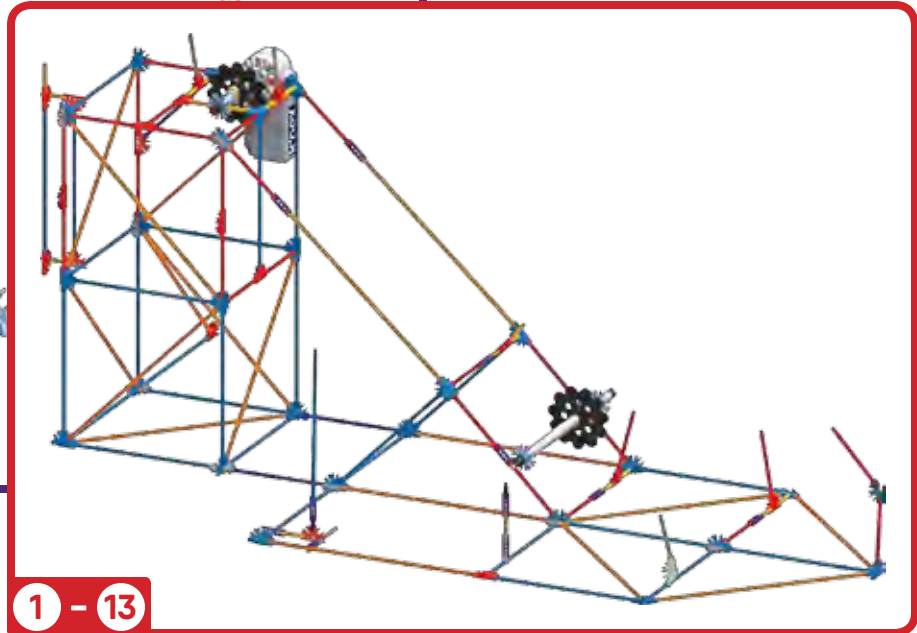

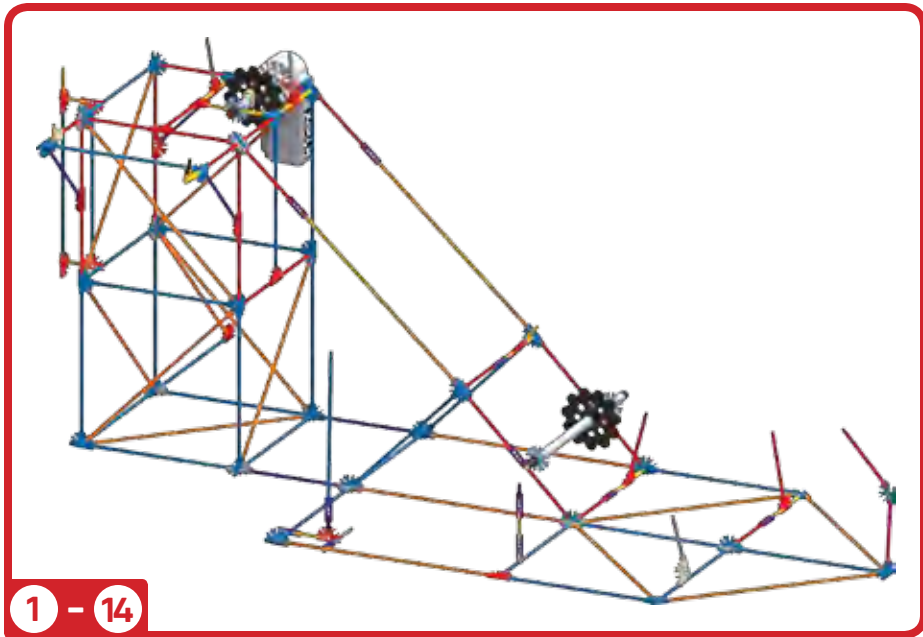

1 - 14

14

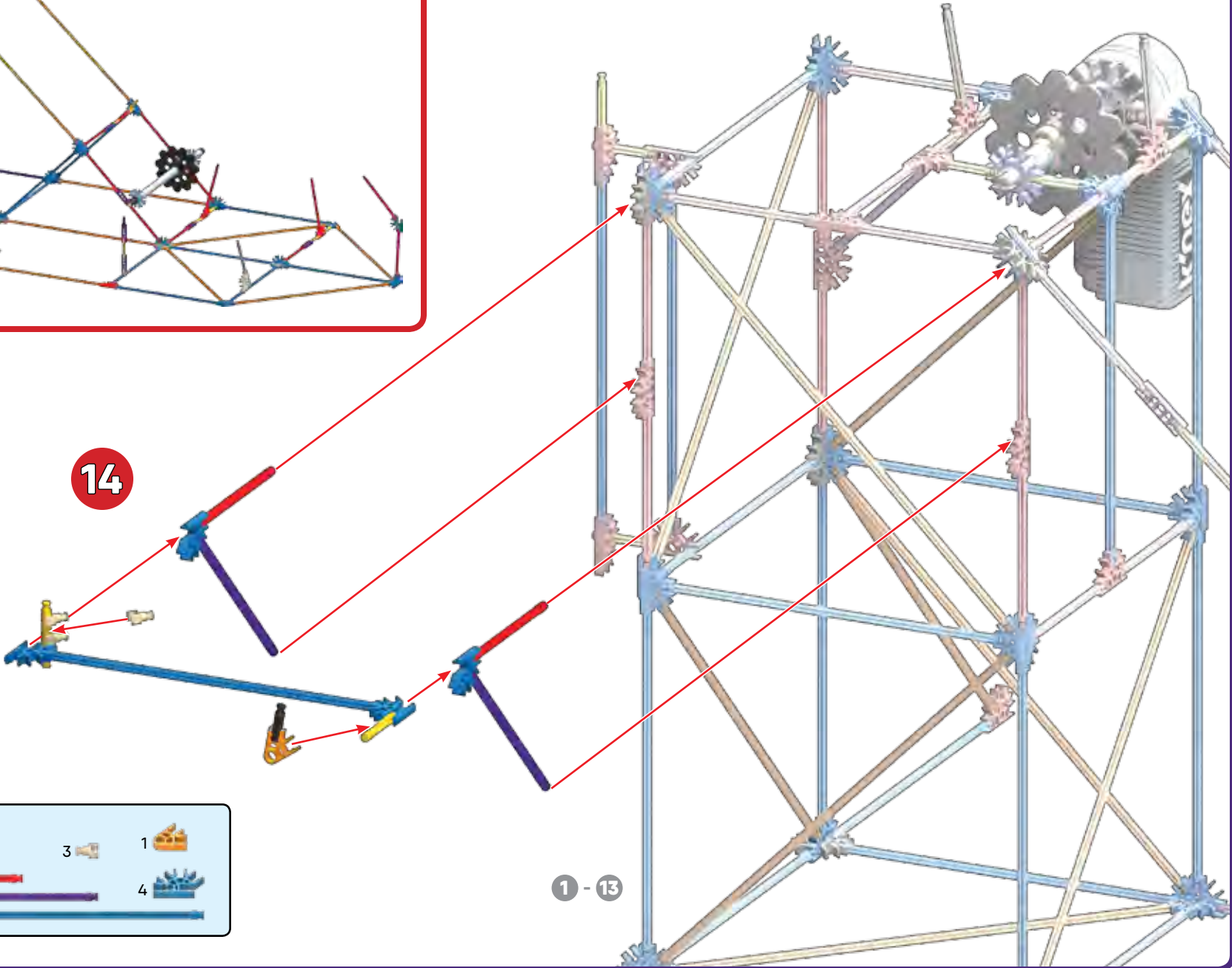

1 - 13

- | | | | | | |
|---|--|---|--|---|--|
| 1 | | 3 | | 1 | |
| 2 | | | | | |
| 2 | | | | 4 | |
| 2 | | | | | |
| 1 | | | | | |

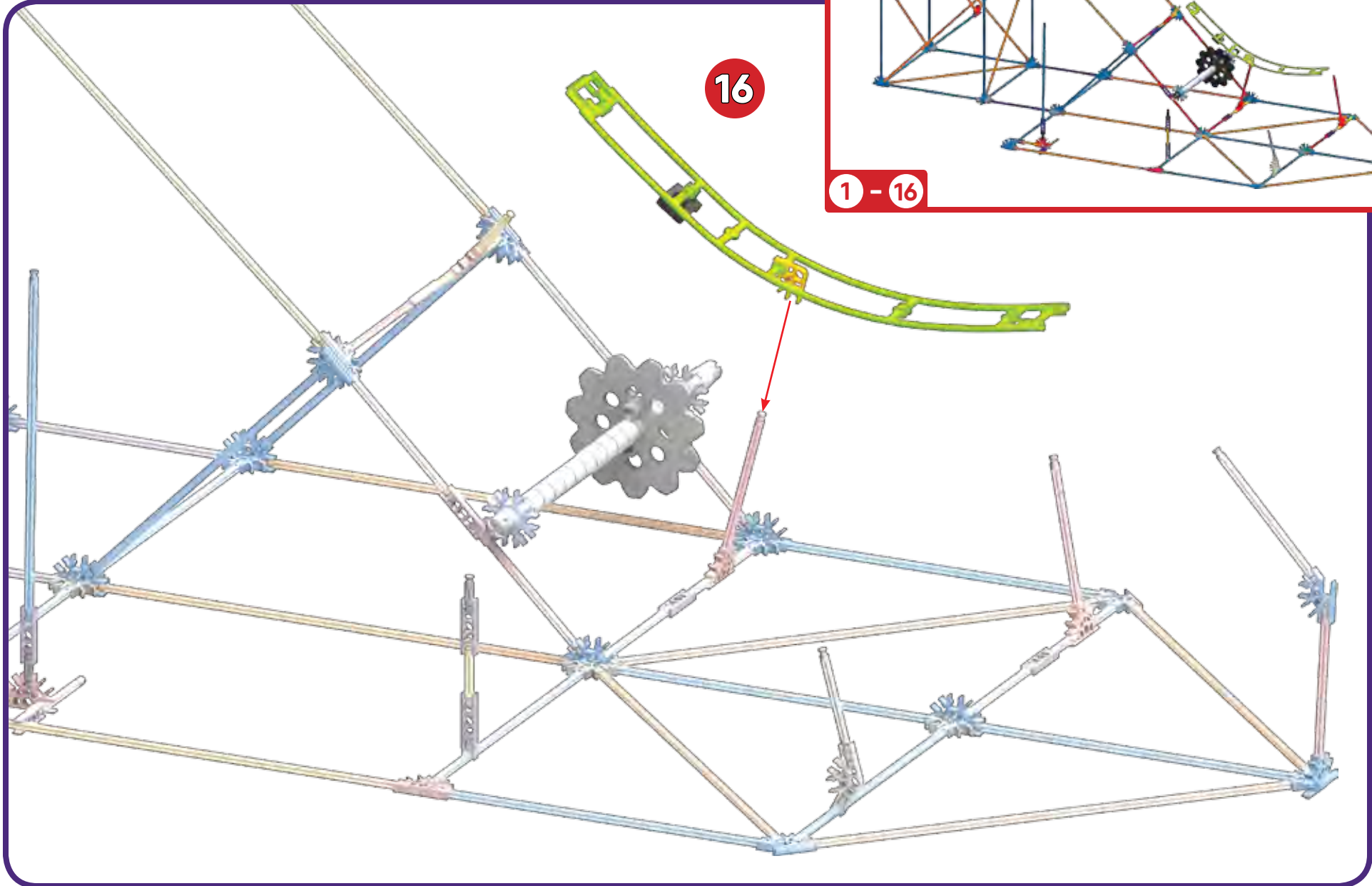
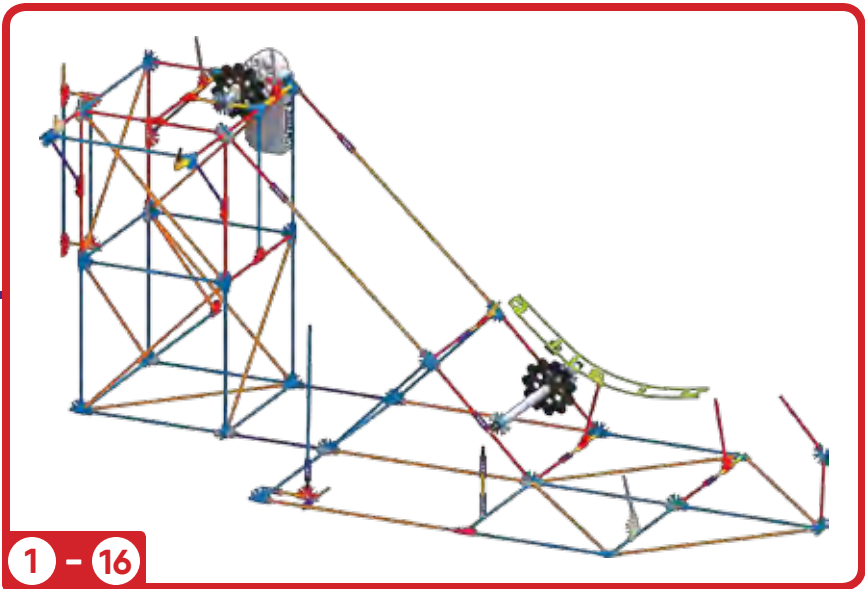
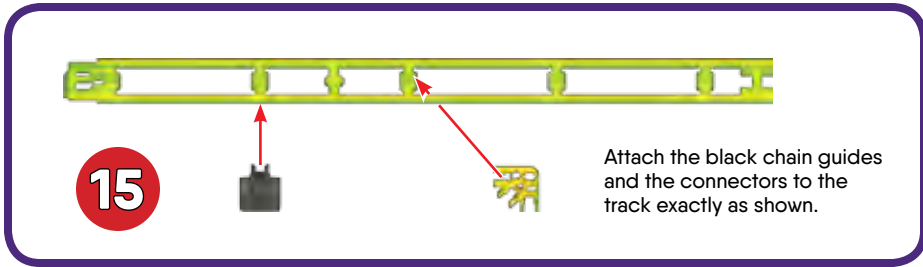

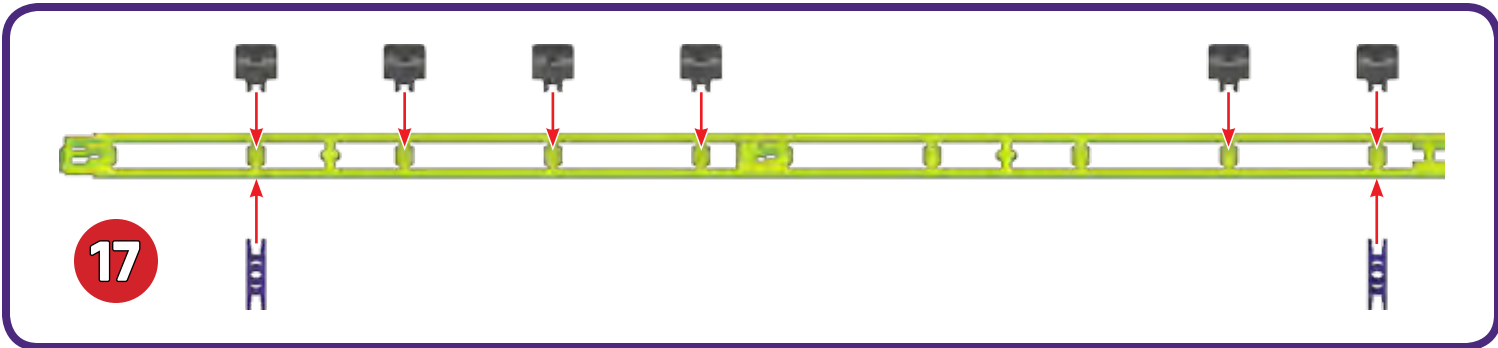

17

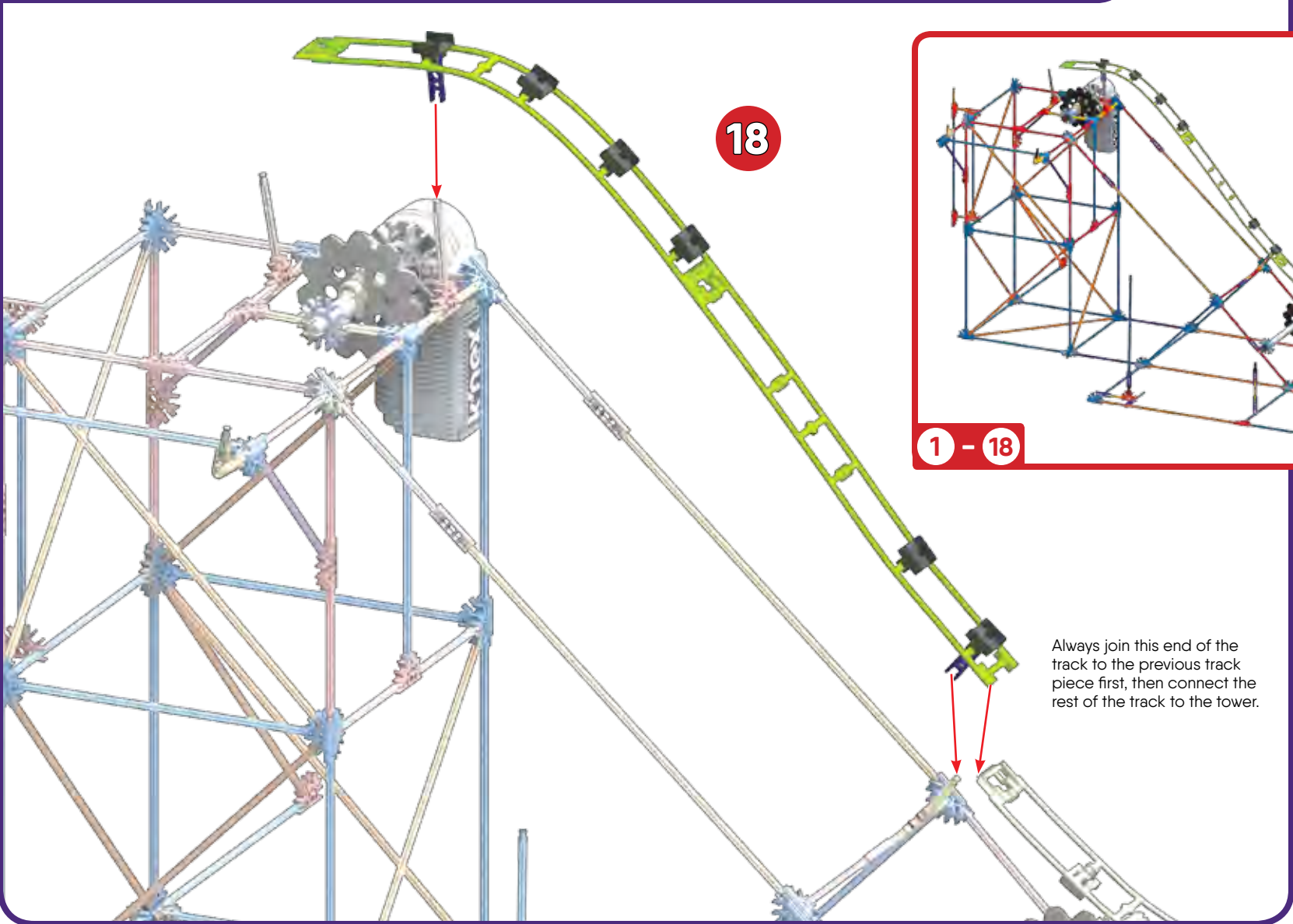

18



1 - 18

Always join this end of the track to the previous track piece first, then connect the rest of the track to the tower.

19

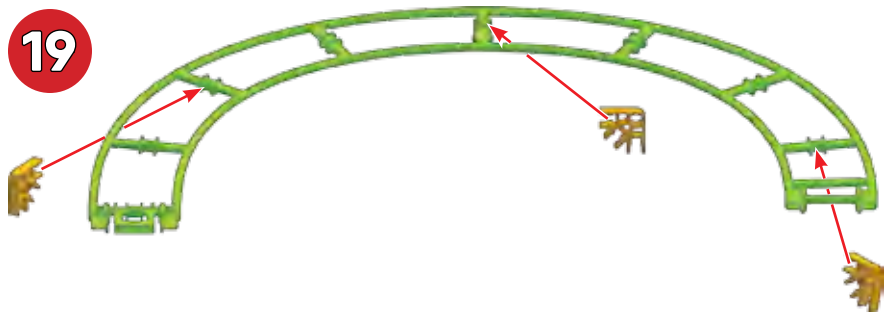

20

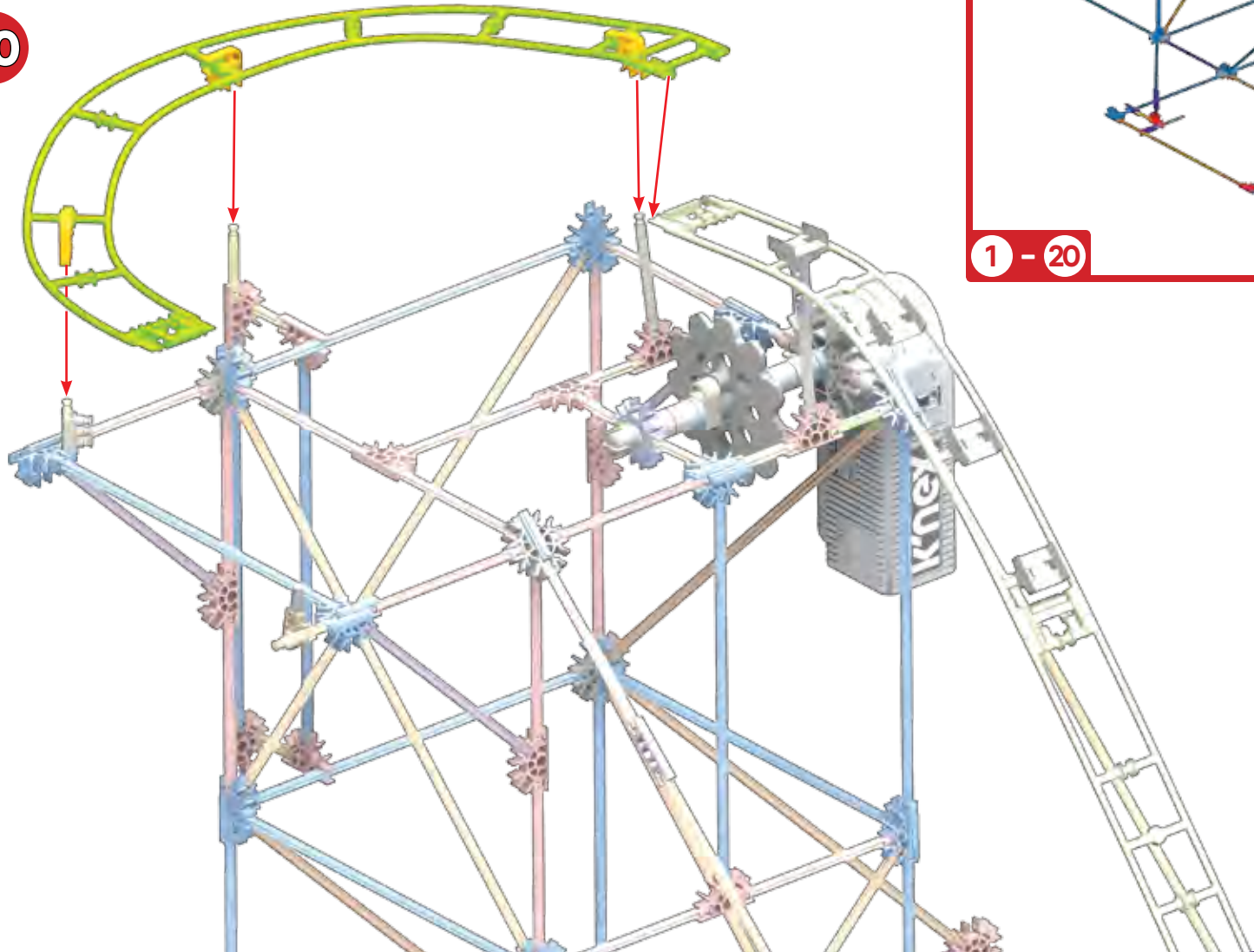

1 - 20

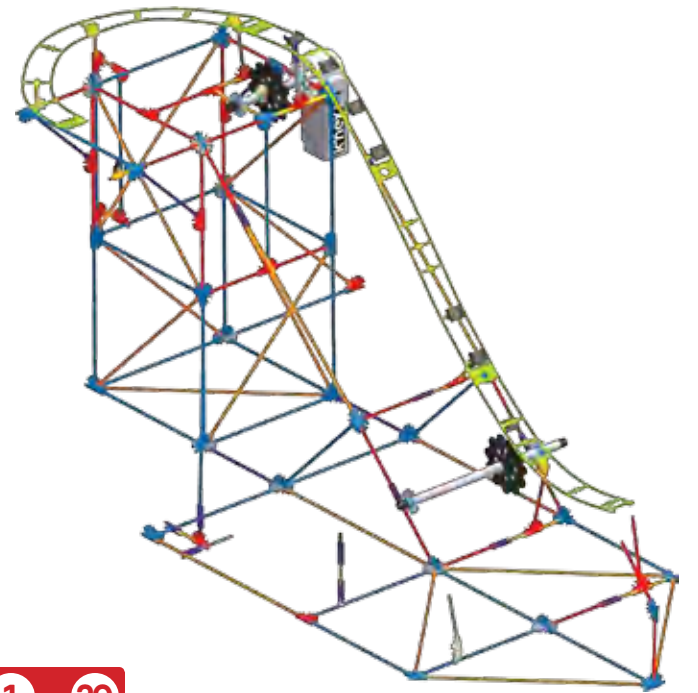

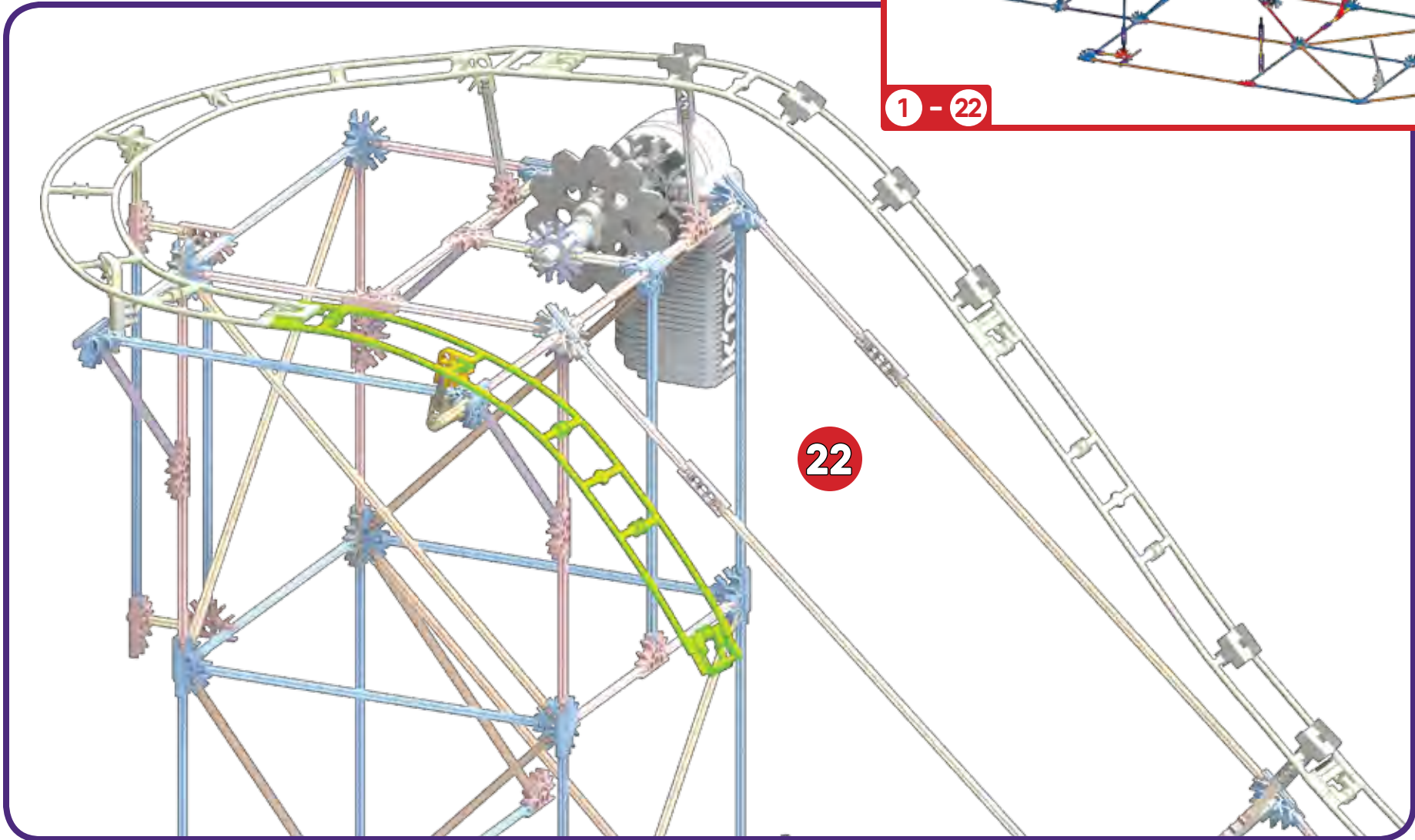
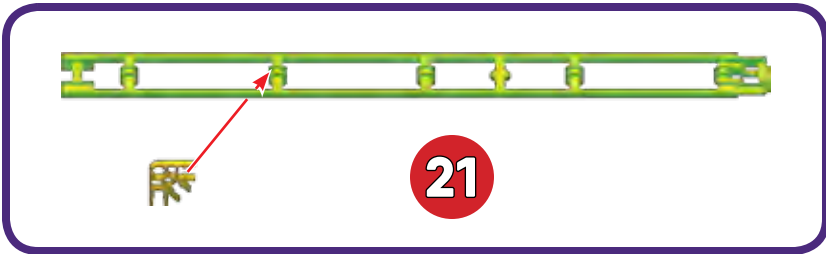

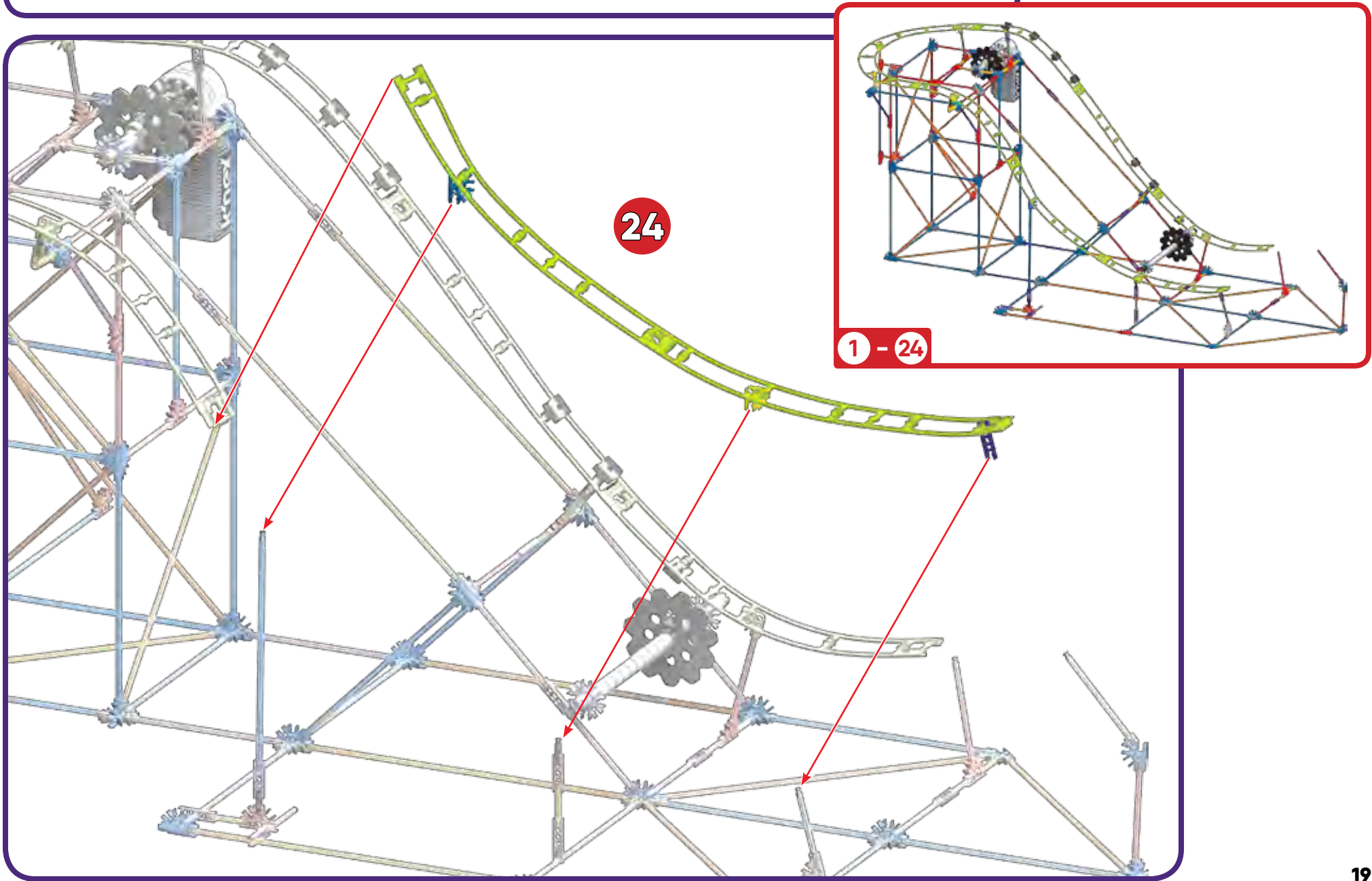
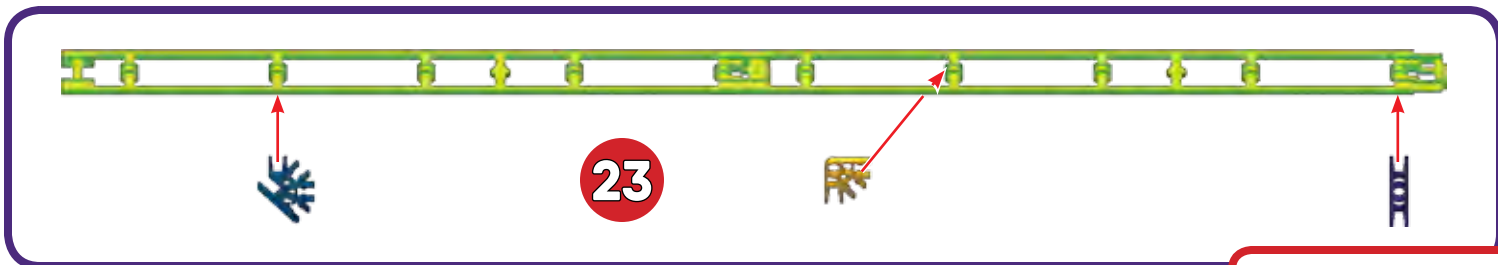

25

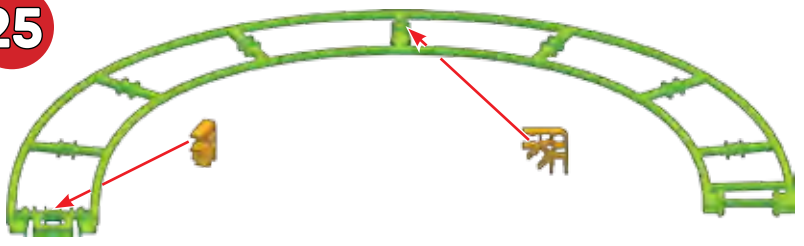

1 - 26



26

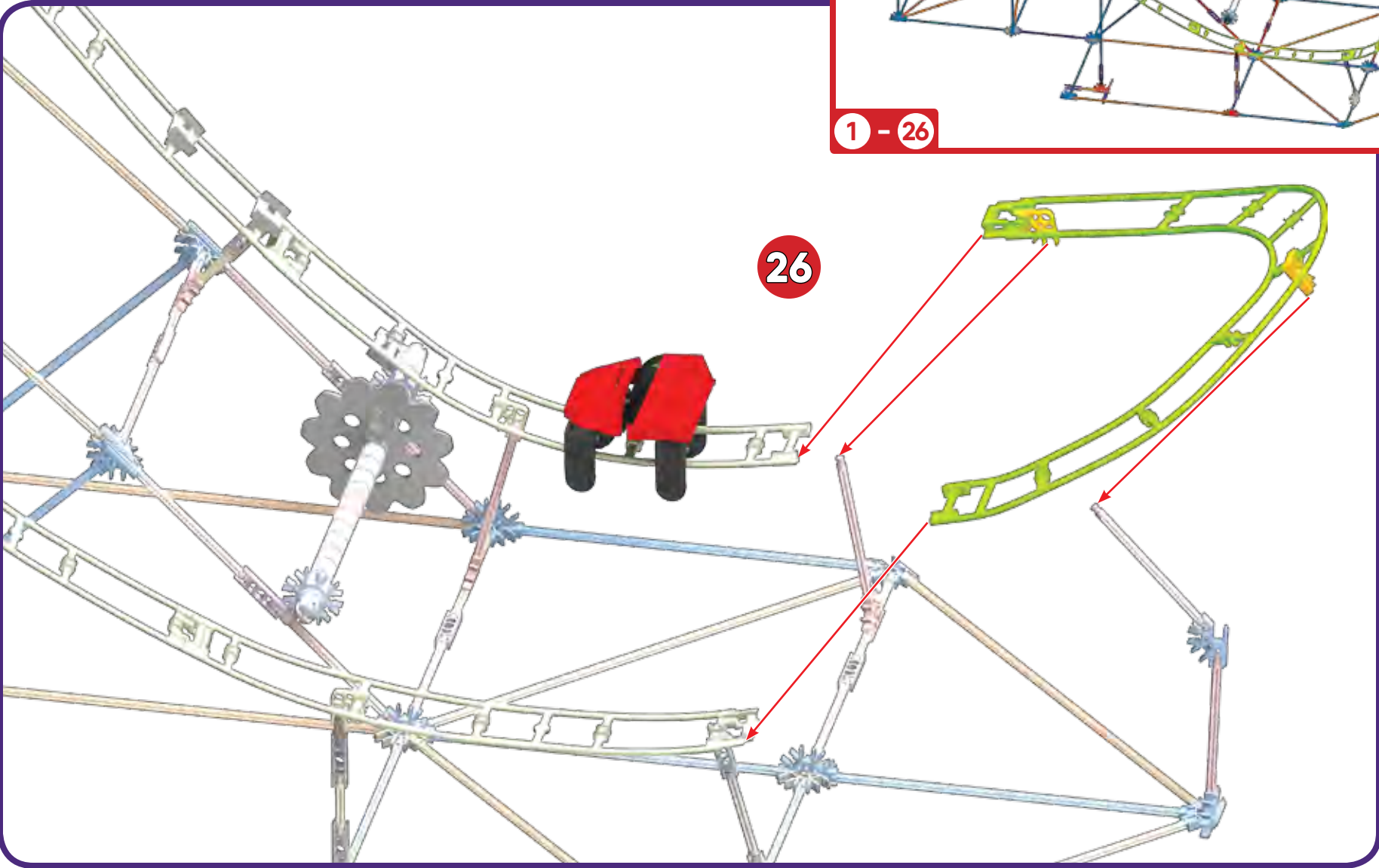



IMPORTANT: Attach all the chain links in the same direction.

27



x3

x1

28



x10

x7

29

28

28

28

28

28

28

28

27

k'nex

T-REX FURY
Additional Build

1 - 30

30

