

15214

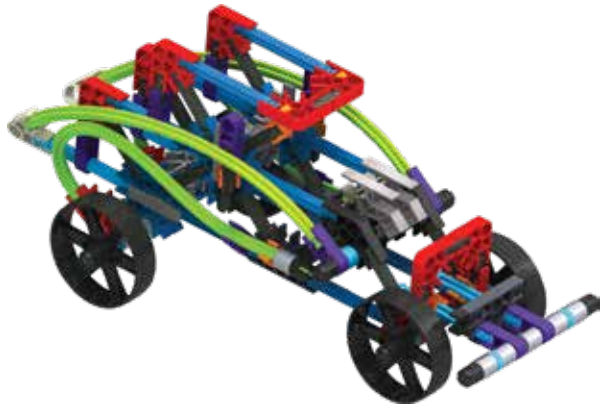

# RAD RIDES Alternate Builds



**3 Wheeler**  
page 1



**Big Rig**  
page 8



**Coupe Racer**  
page 17



**Hot Rod**  
page 24



**Amphibious  
Vehicle**  
page 33



**Super Car**  
page 41



**Rocket Racer**  
page 47



**SUV**  
page 53



**Tow Truck**  
page 60



1

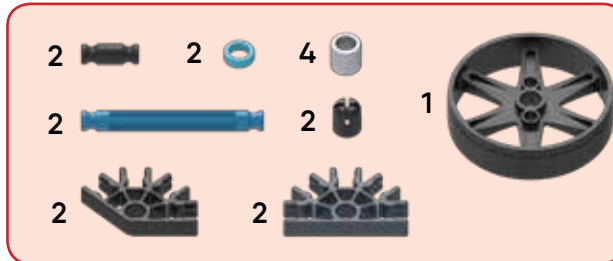
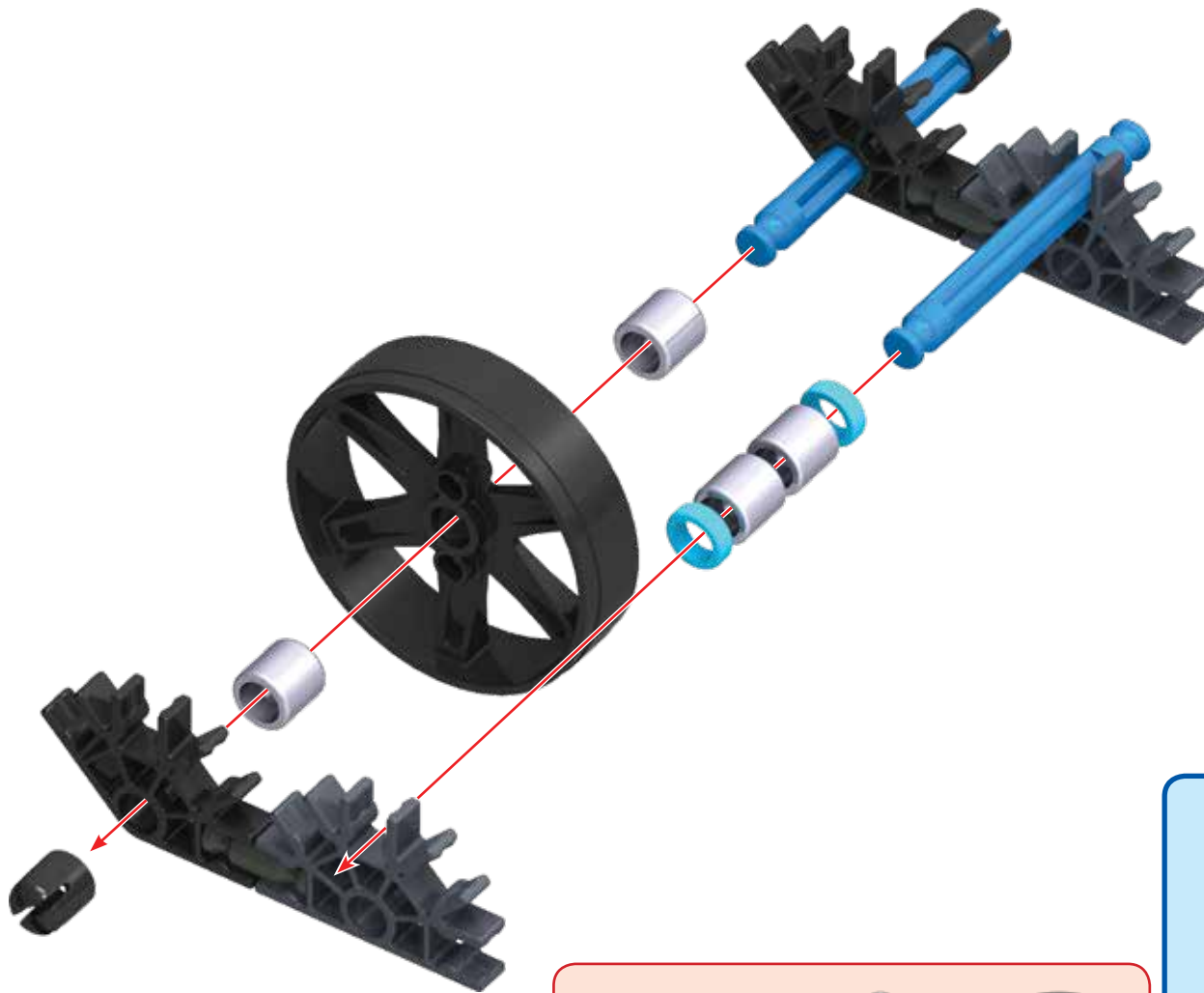

2

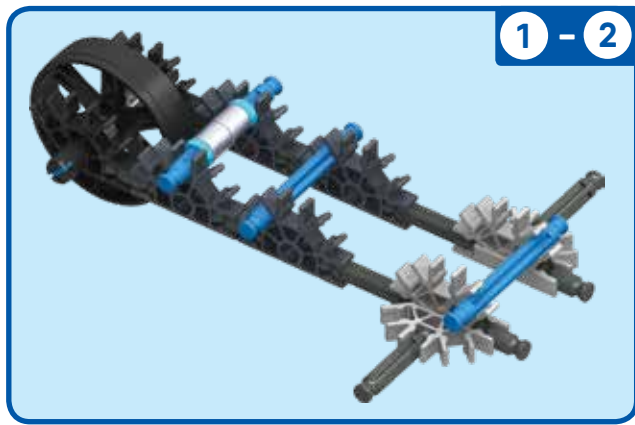
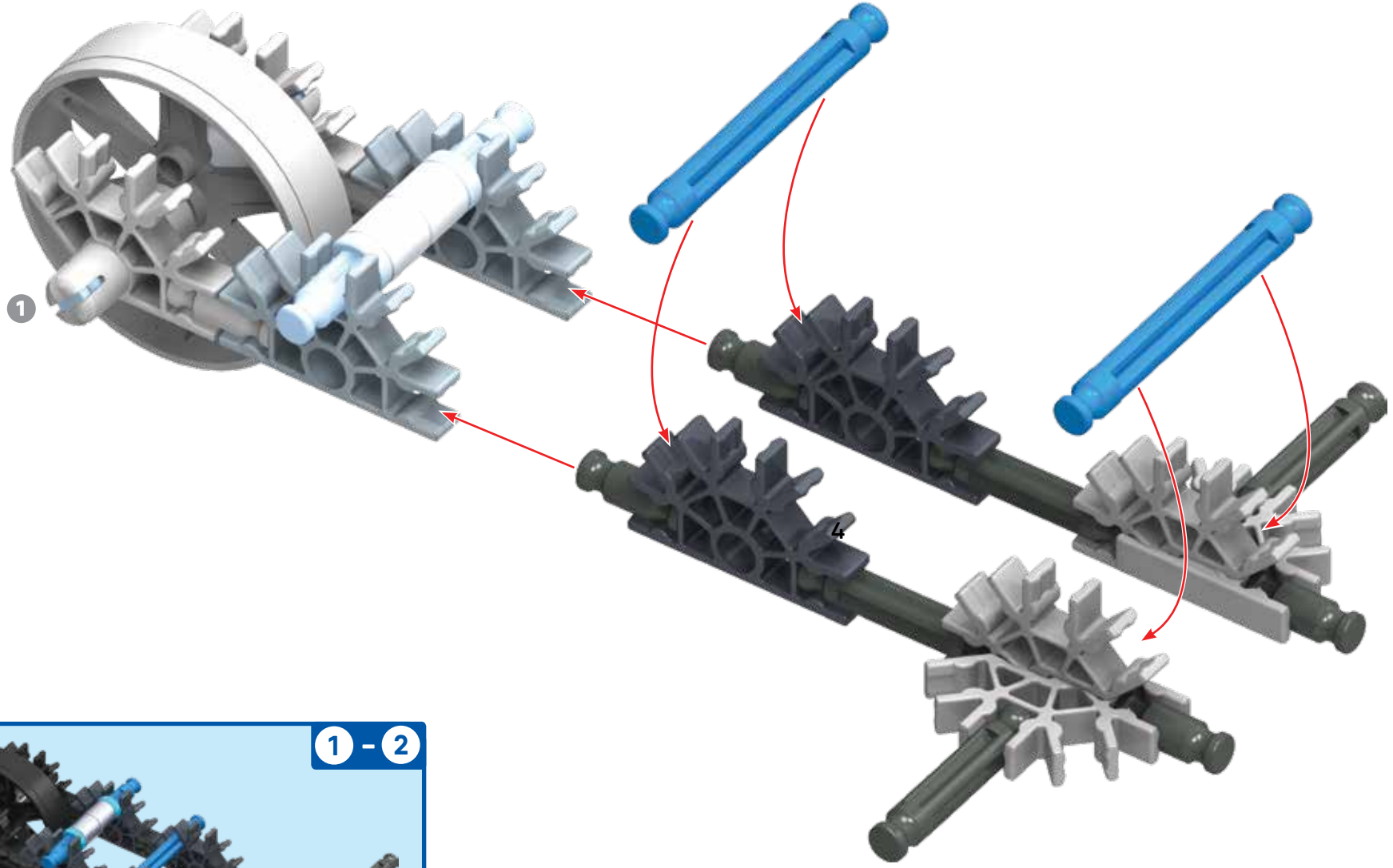

- 4 [Small grey gear-like component]
- 4 [Long dark grey axle]
- 2 [Blue pin]
- 4 [Grey gear-like component]
- 2 [Dark grey gear-like component]

3

- |   |  |   |  |   |  |   |  |
|---|--|---|--|---|--|---|--|
| 4 |  | 2 |  | 1 |  |   |  |
| 2 |  | 6 |  | 4 |  | 2 |  |
| 2 |  | 2 |  | 2 |  |   |  |

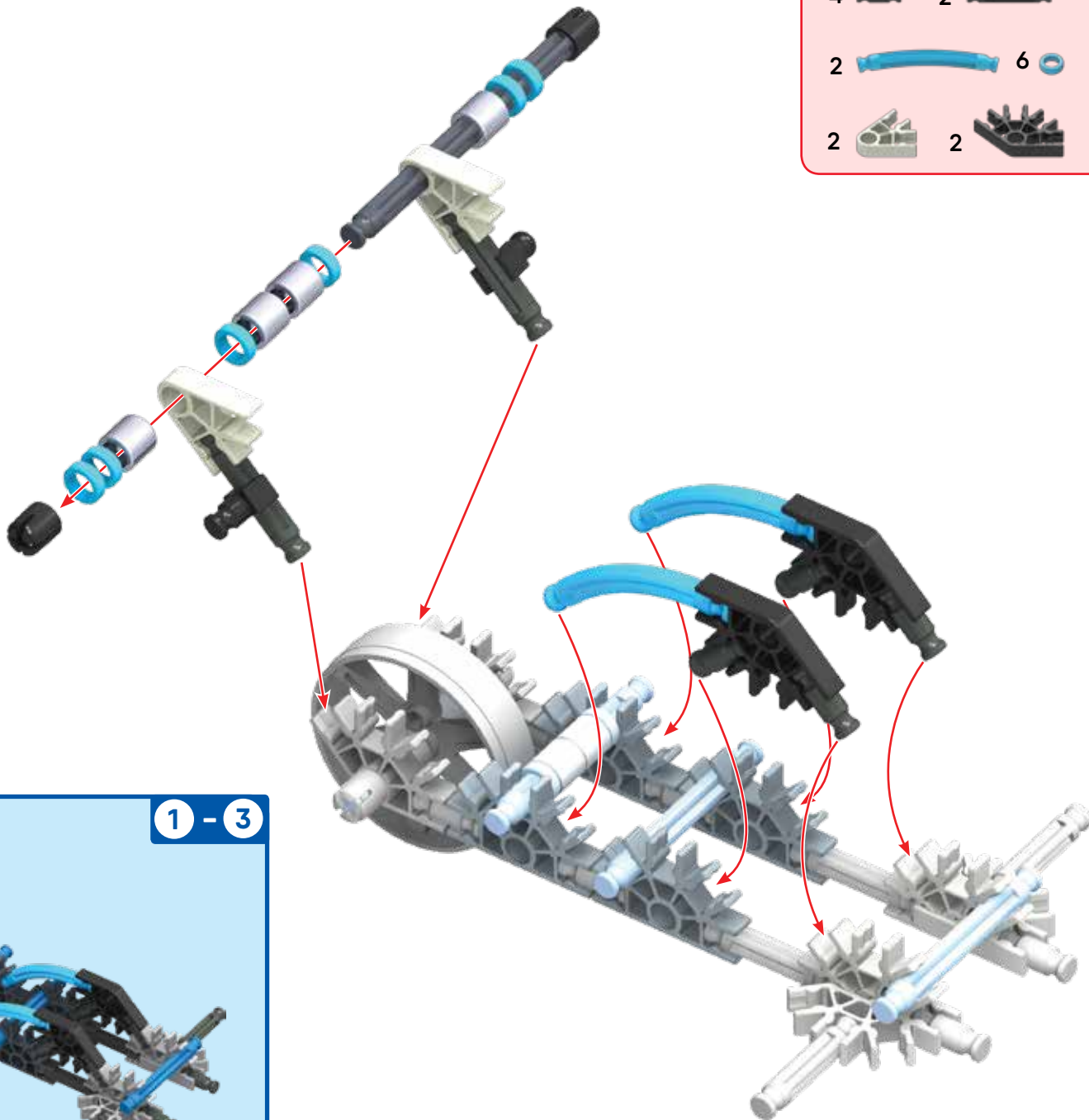

1 - 3

1 - 2

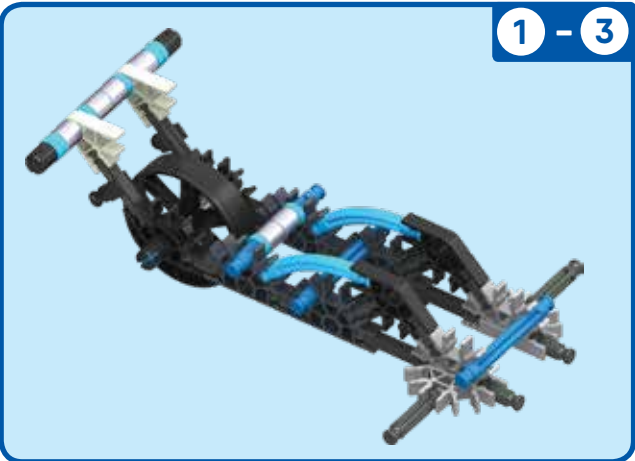

4

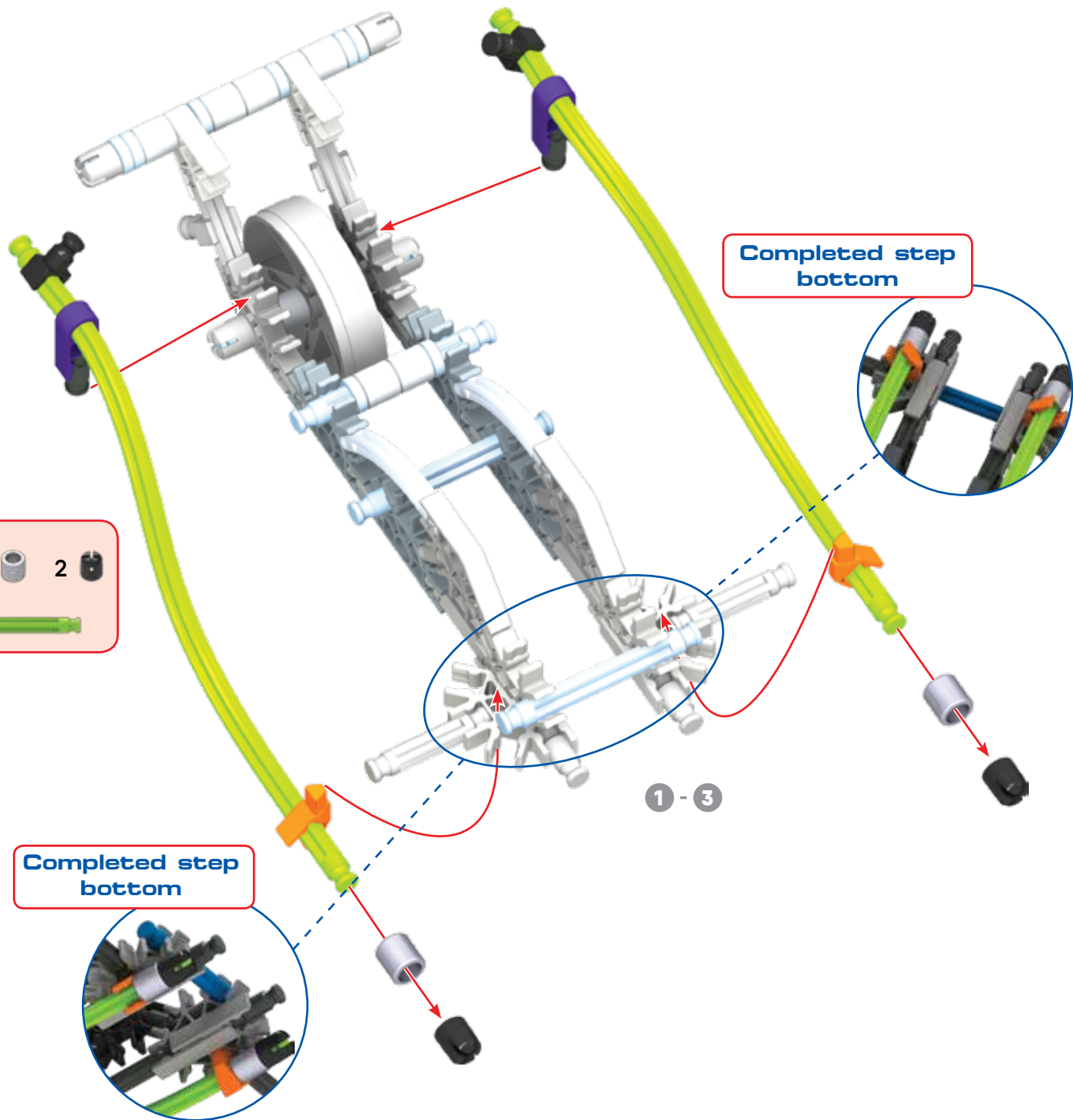

- 2 [black pin]
- 2 [black pin]
- 2 [orange pin]
- 2 [purple pin]
- 2 [grey pin]
- 2 [black pin]
- 2 [green beam]



Completed step bottom

Completed step bottom

1 - 3

5

- 1 
- 2 
- 2 
- 4 
- 4 
- 2 

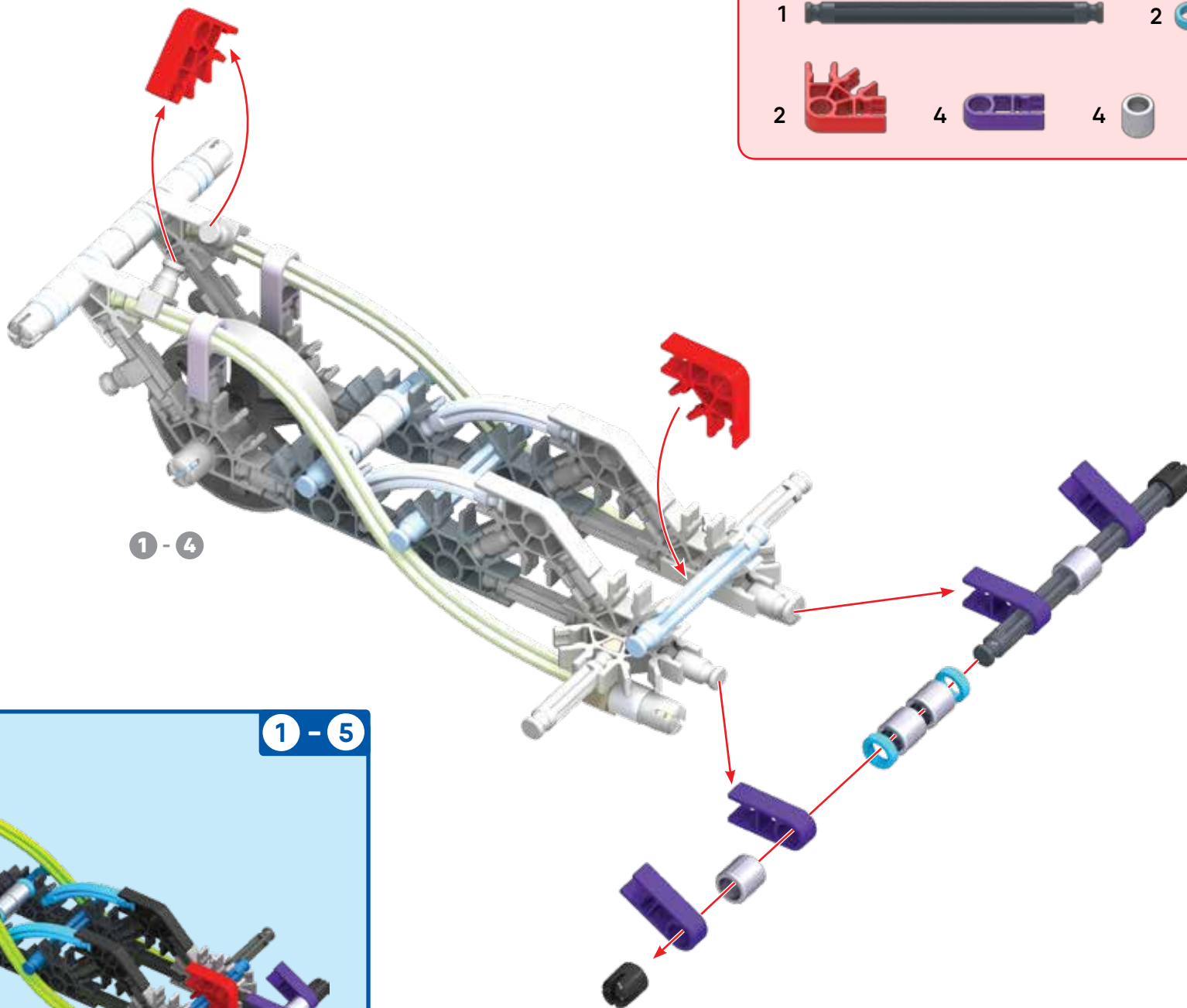

1 - 5

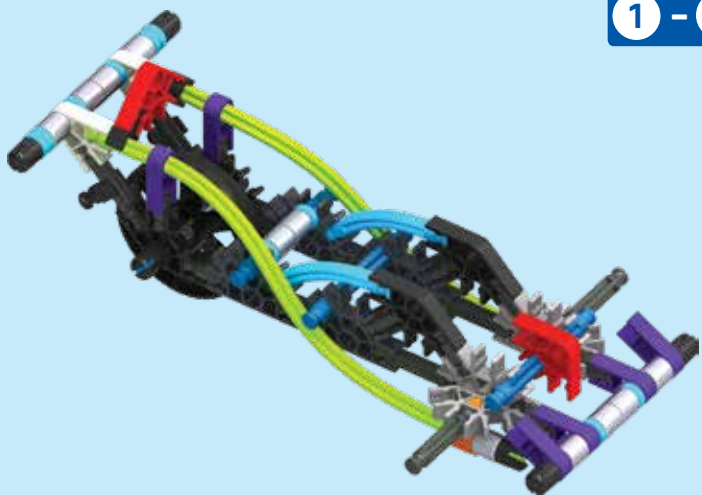



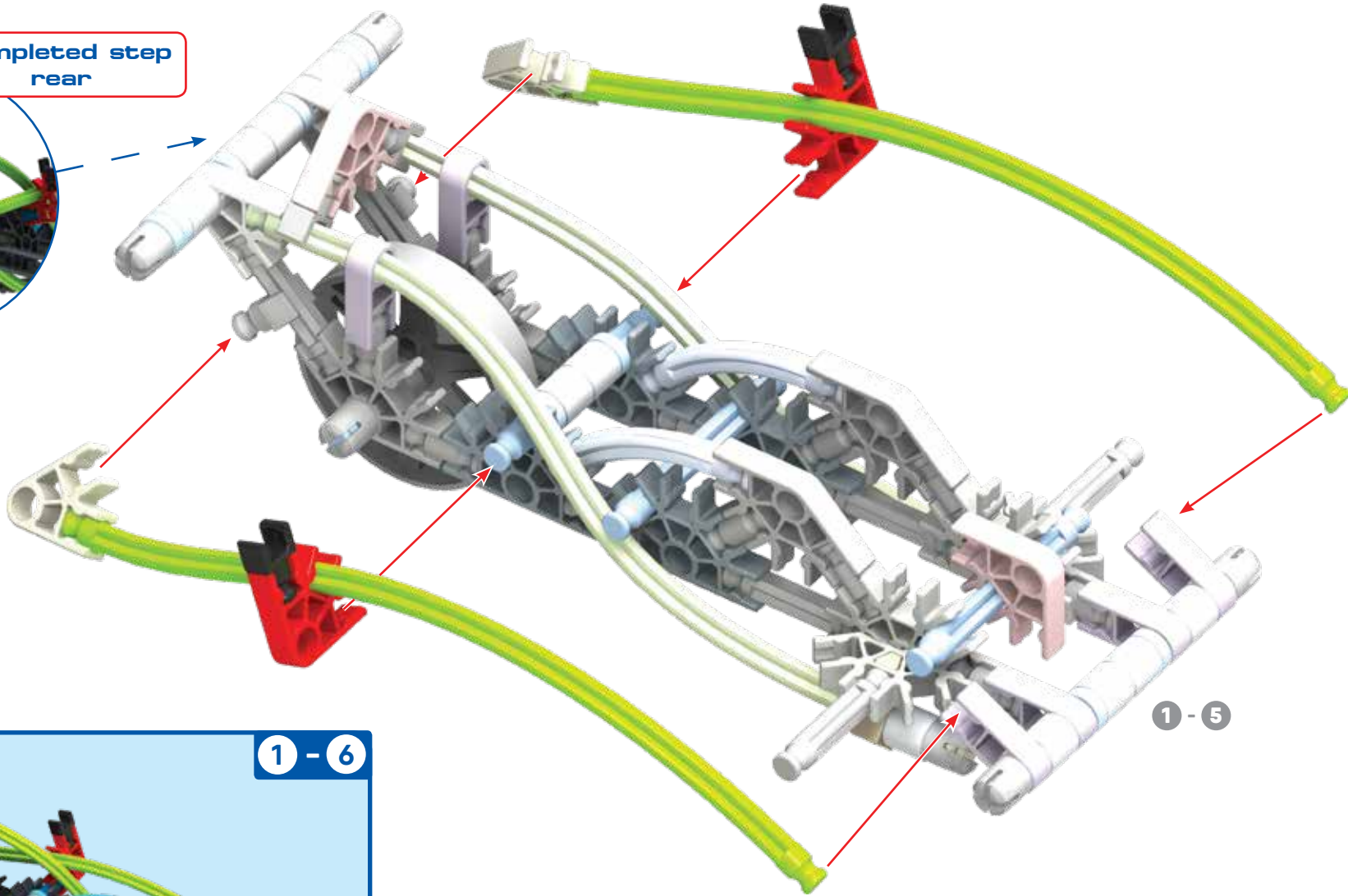

6

Completed step rear

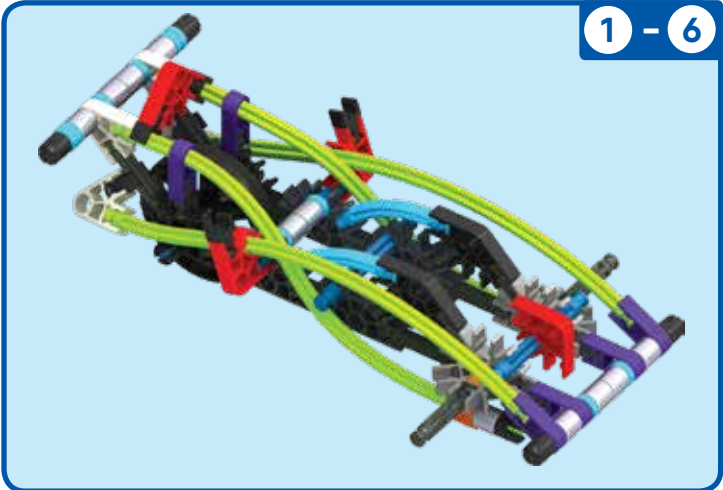

1 - 6







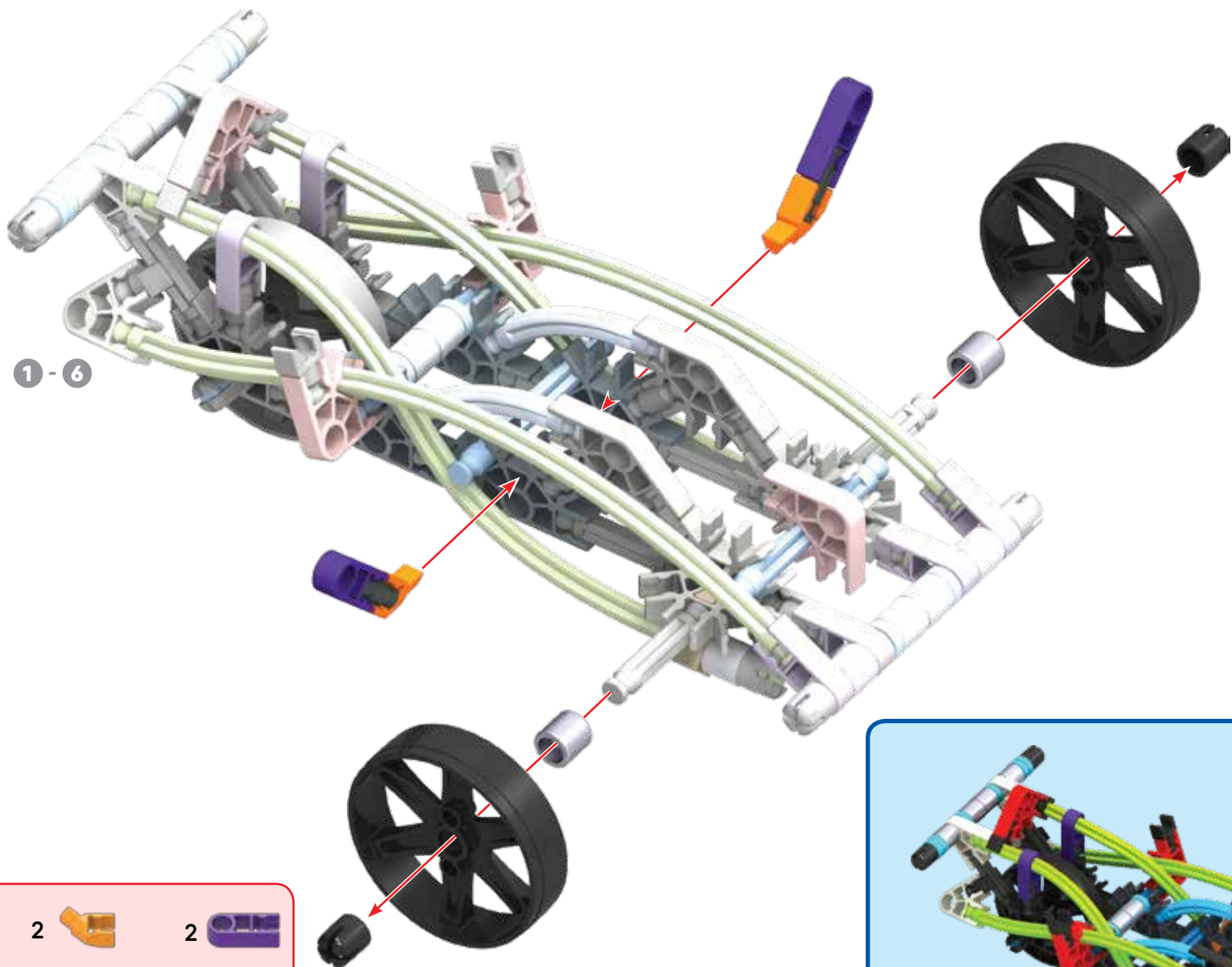

- 2  2  2 
- 2 

7



1 - 6

- 2 
- 2 
- 2 
- 2 
- 2 
- 2 

1 - 7



3 Wheeler



1

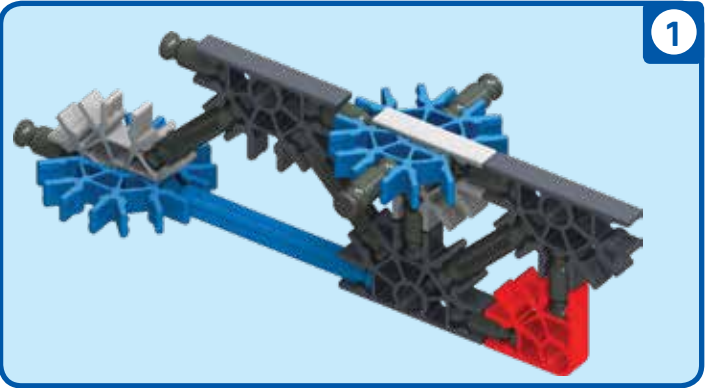
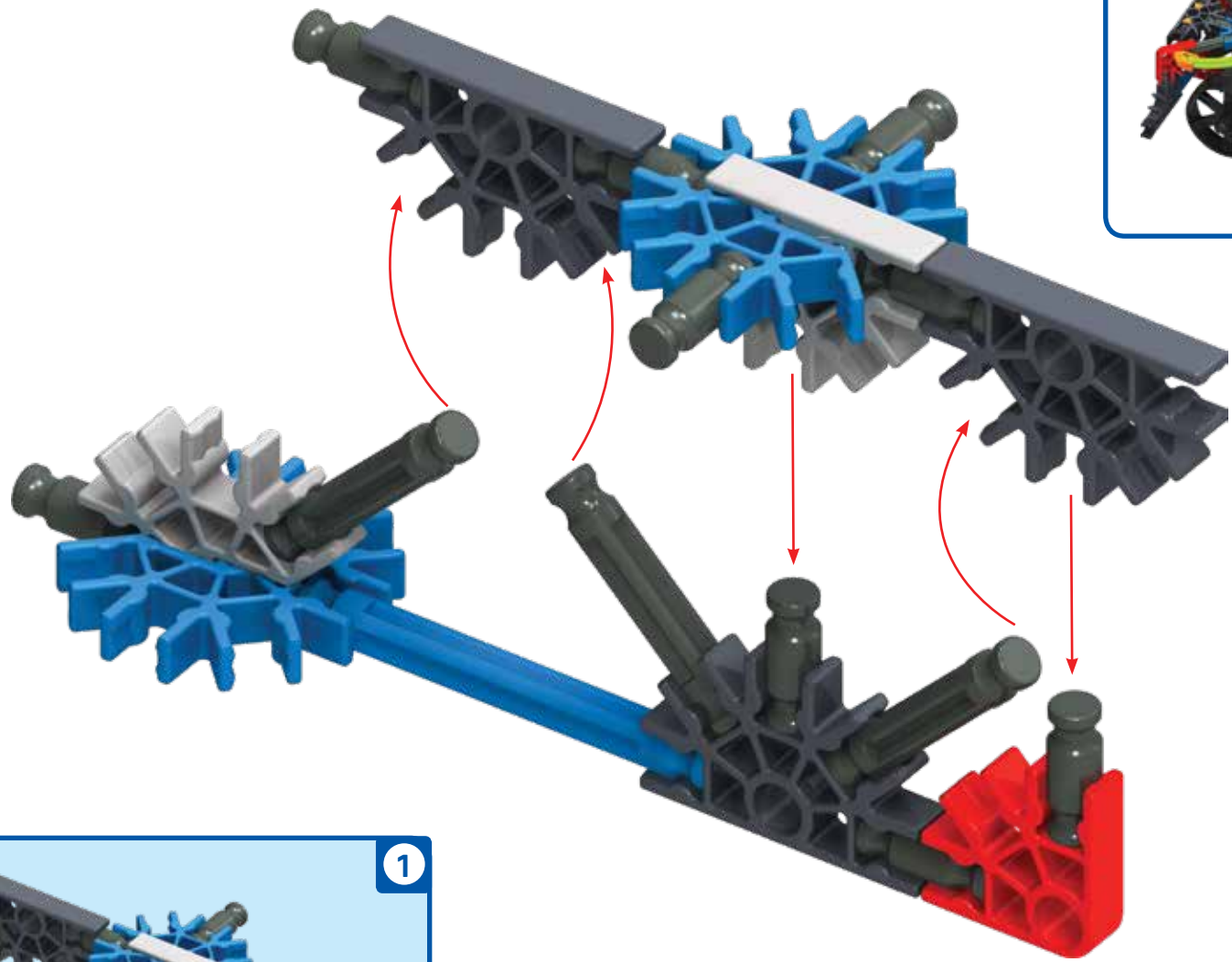

- |   |  |   |  |   |  |   |  |
|---|--|---|--|---|--|---|--|
| 1 |  | 2 |  | 3 |  | 2 |  |
| 9 |  | 3 |  | 1 |  |   |  |

2

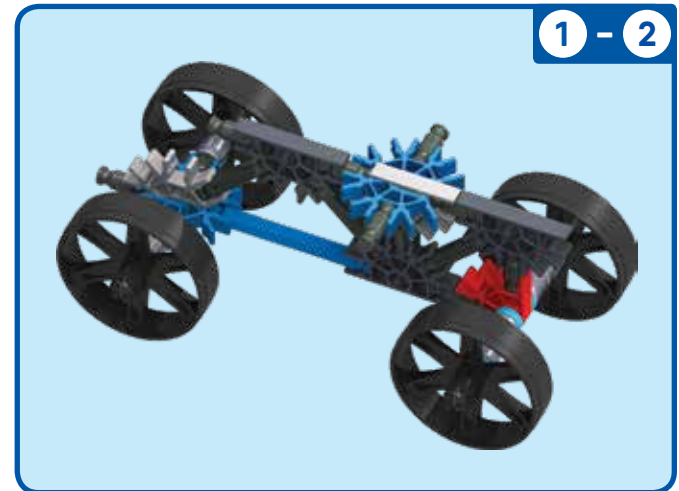
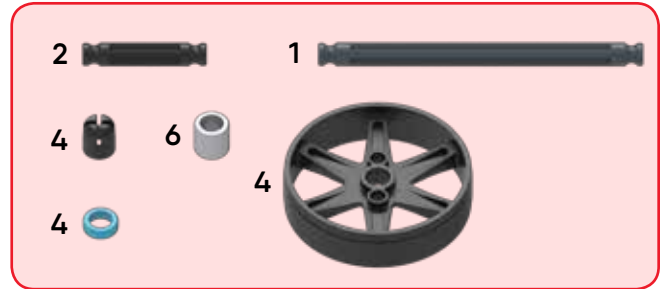
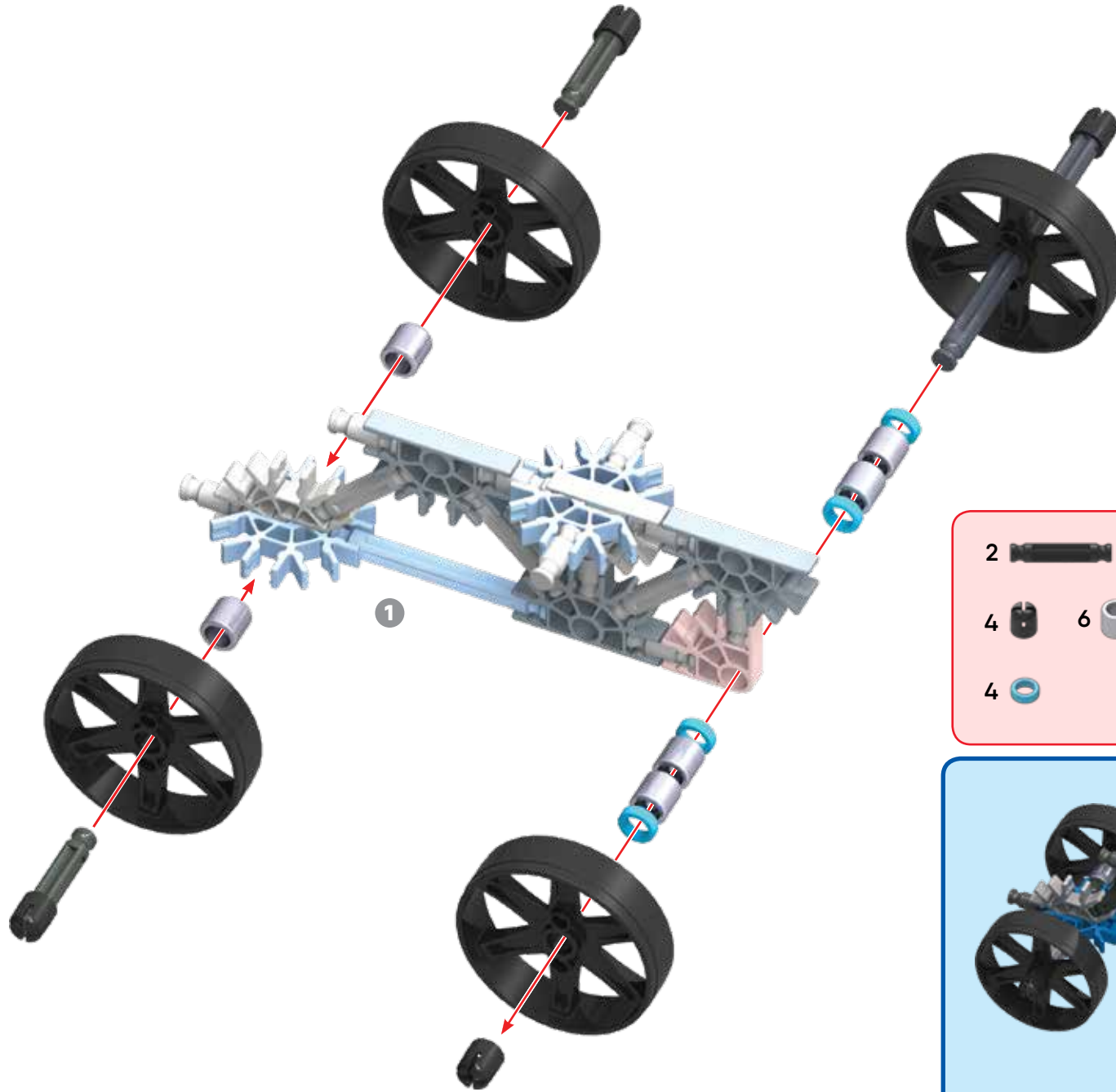

3



- |   |  |   |  |   |  |
|---|--|---|--|---|--|
| 3 |  | 3 |  | 1 |  |
| 3 |  | 5 |  | 1 |  |
| 5 |  | 5 |  |   |  |



4

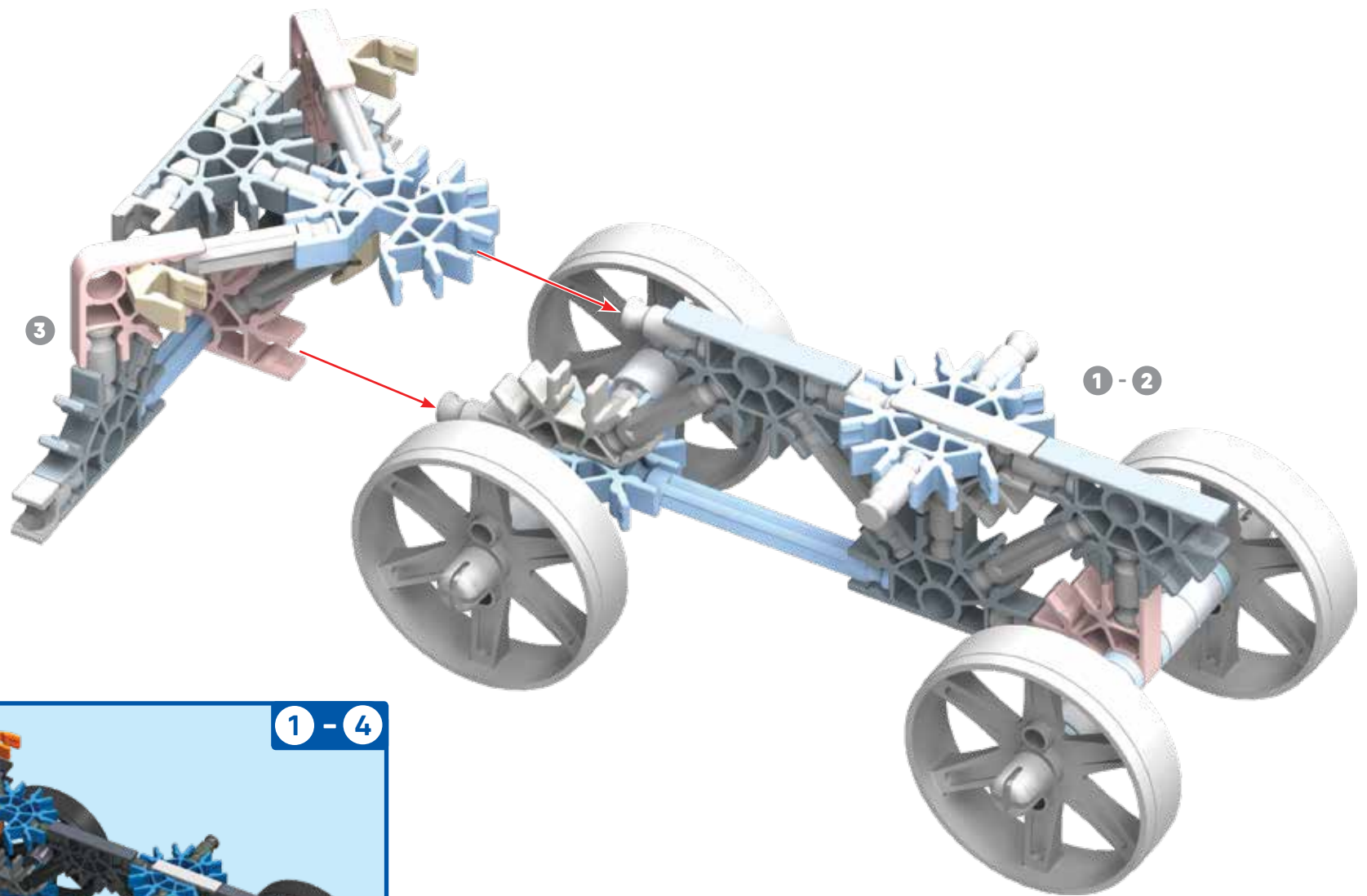

5

- 2
- 2
- 2
- 2
- 2
- 8
- 2
- 1
- 2
- 2

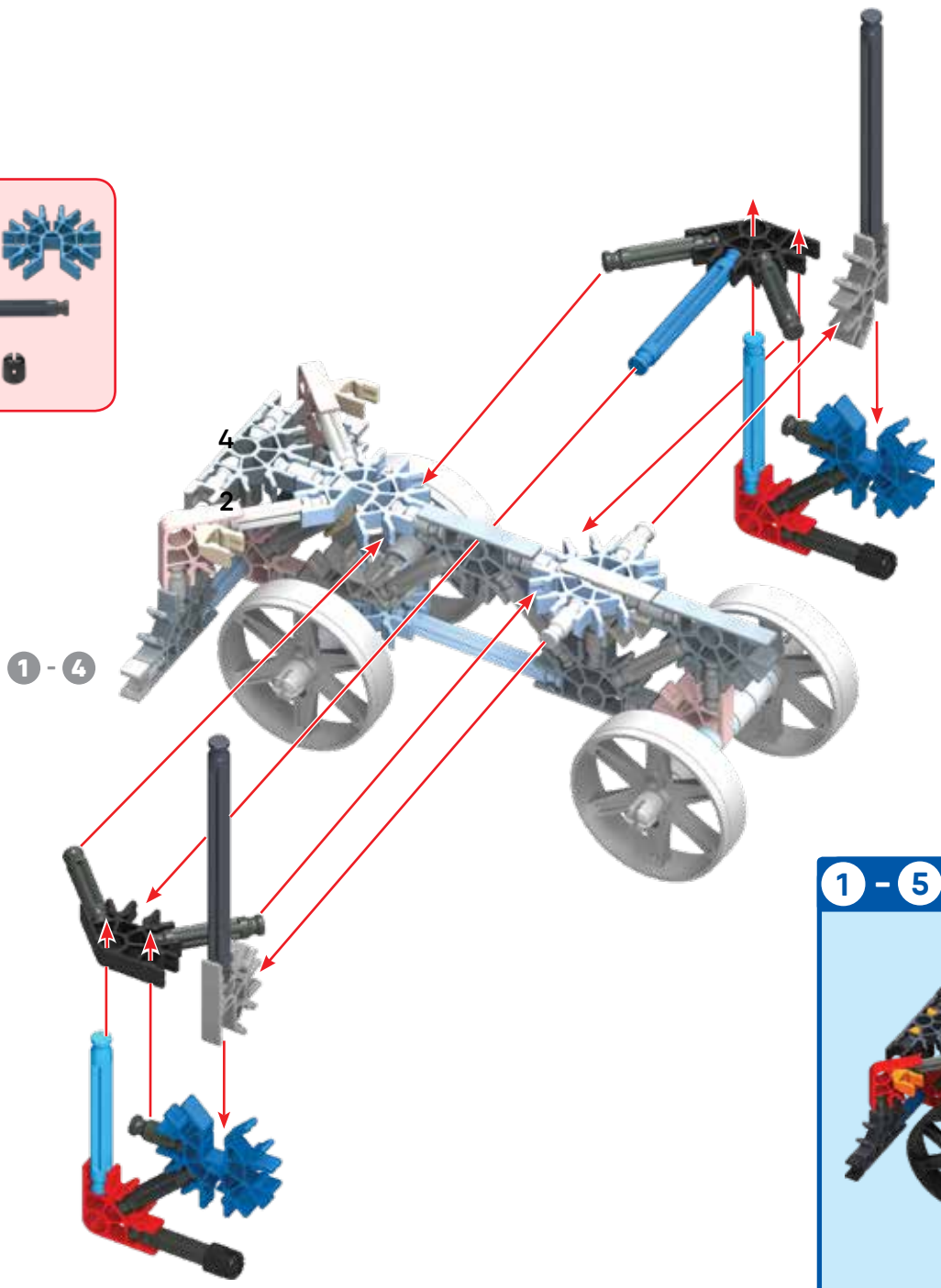

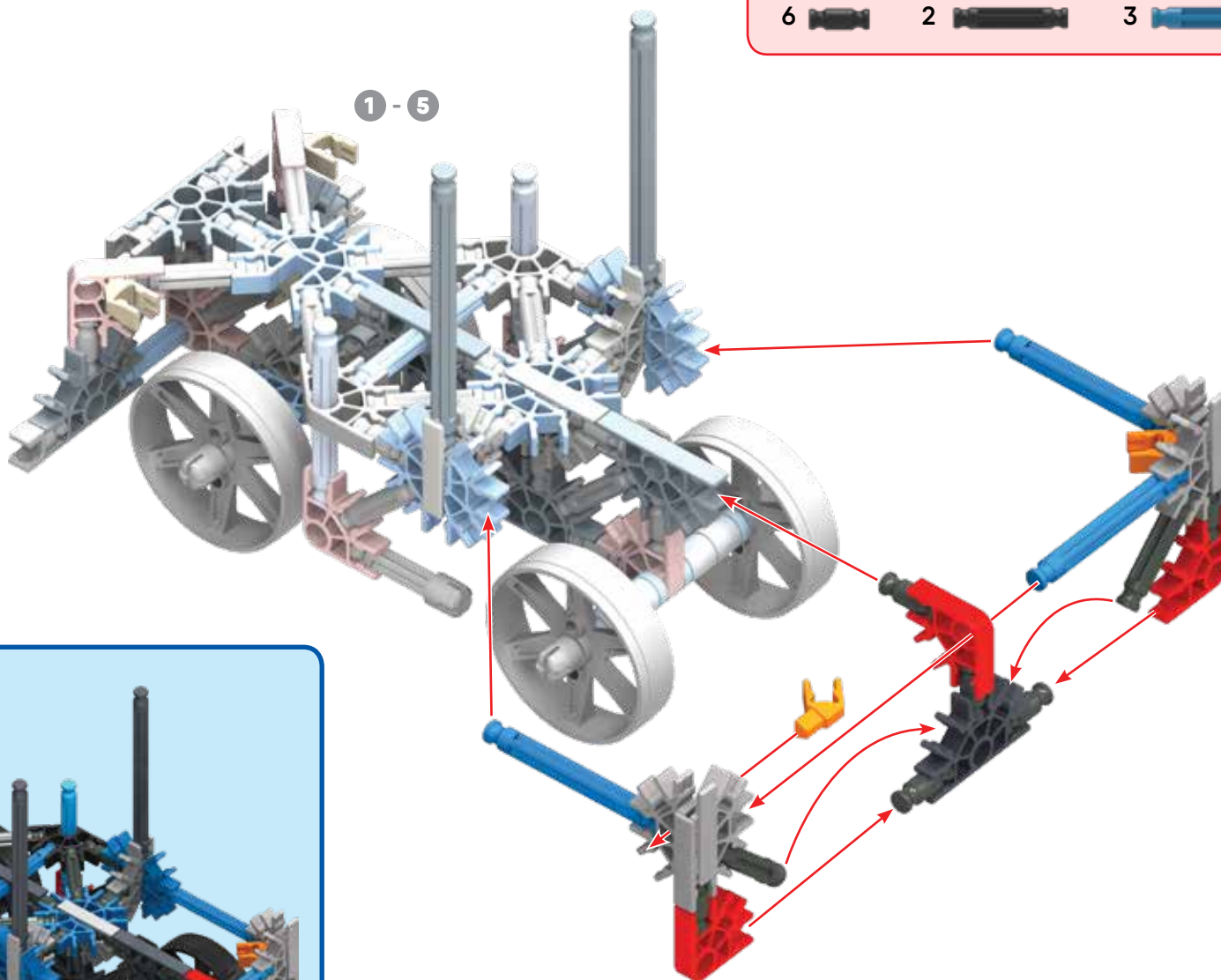
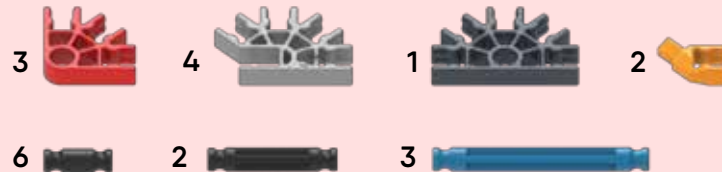

6



1 - 6



7

- 2  2 
- 2 

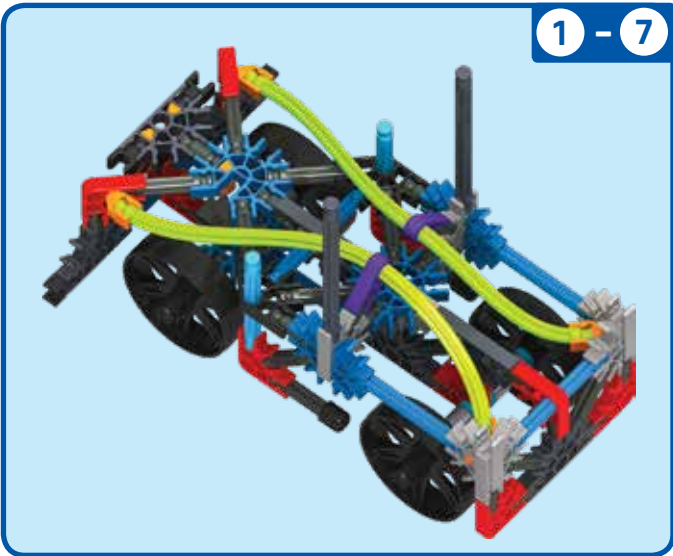
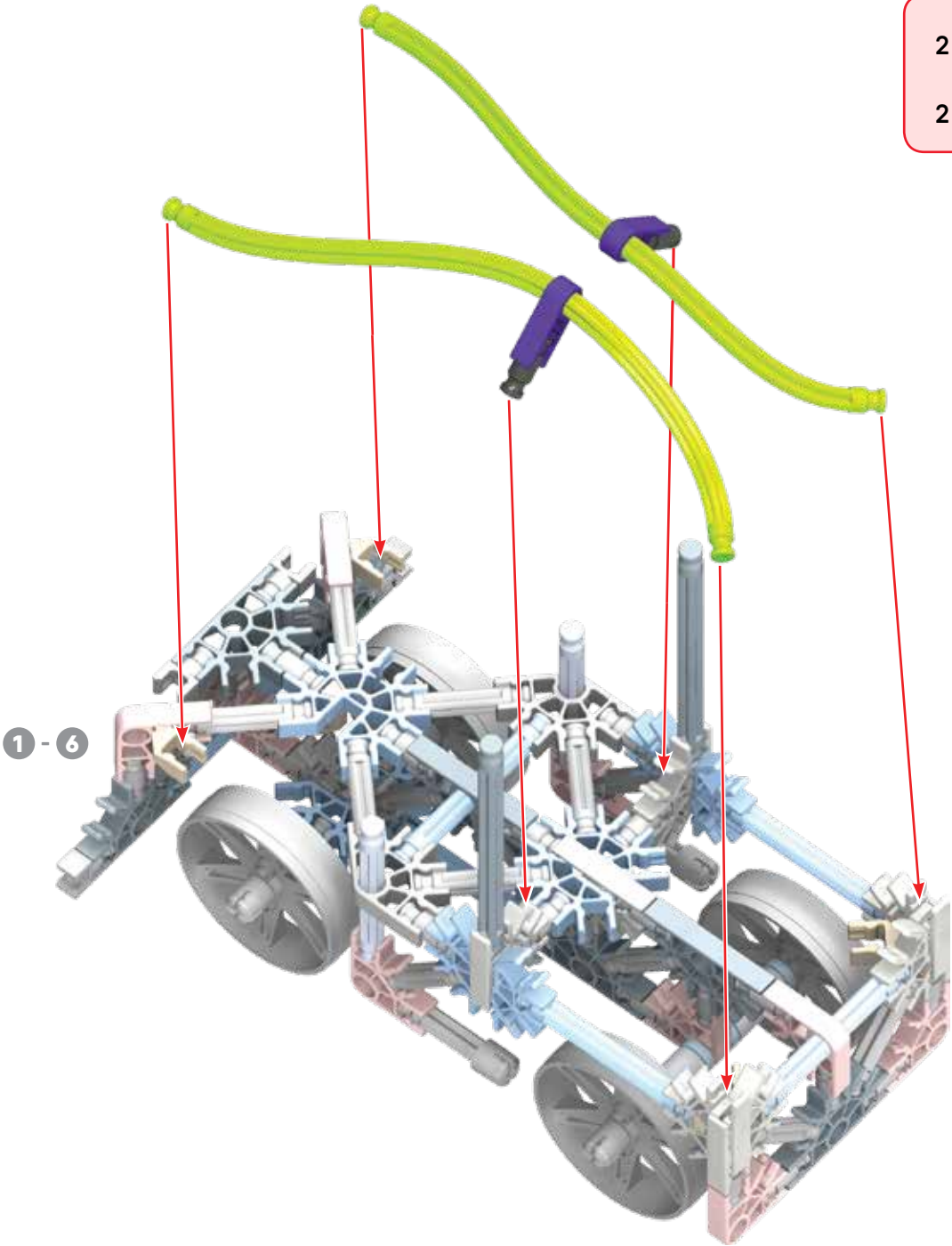

8

8  4 

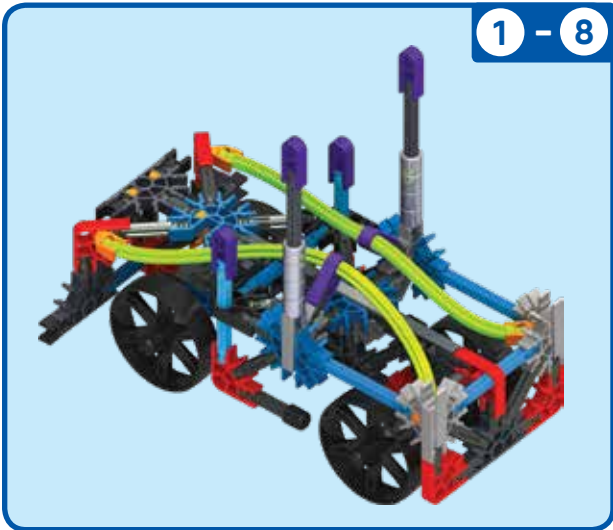
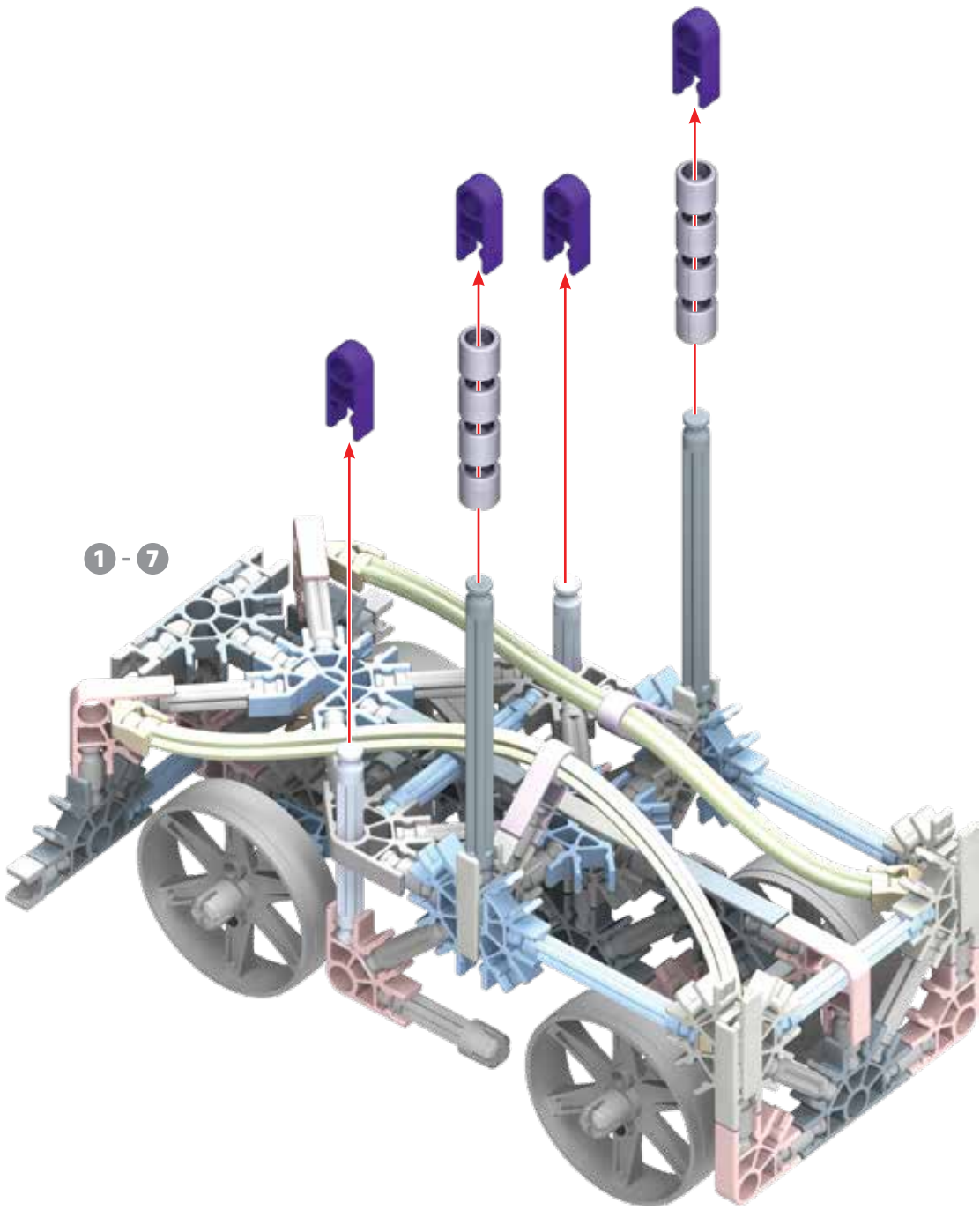



9

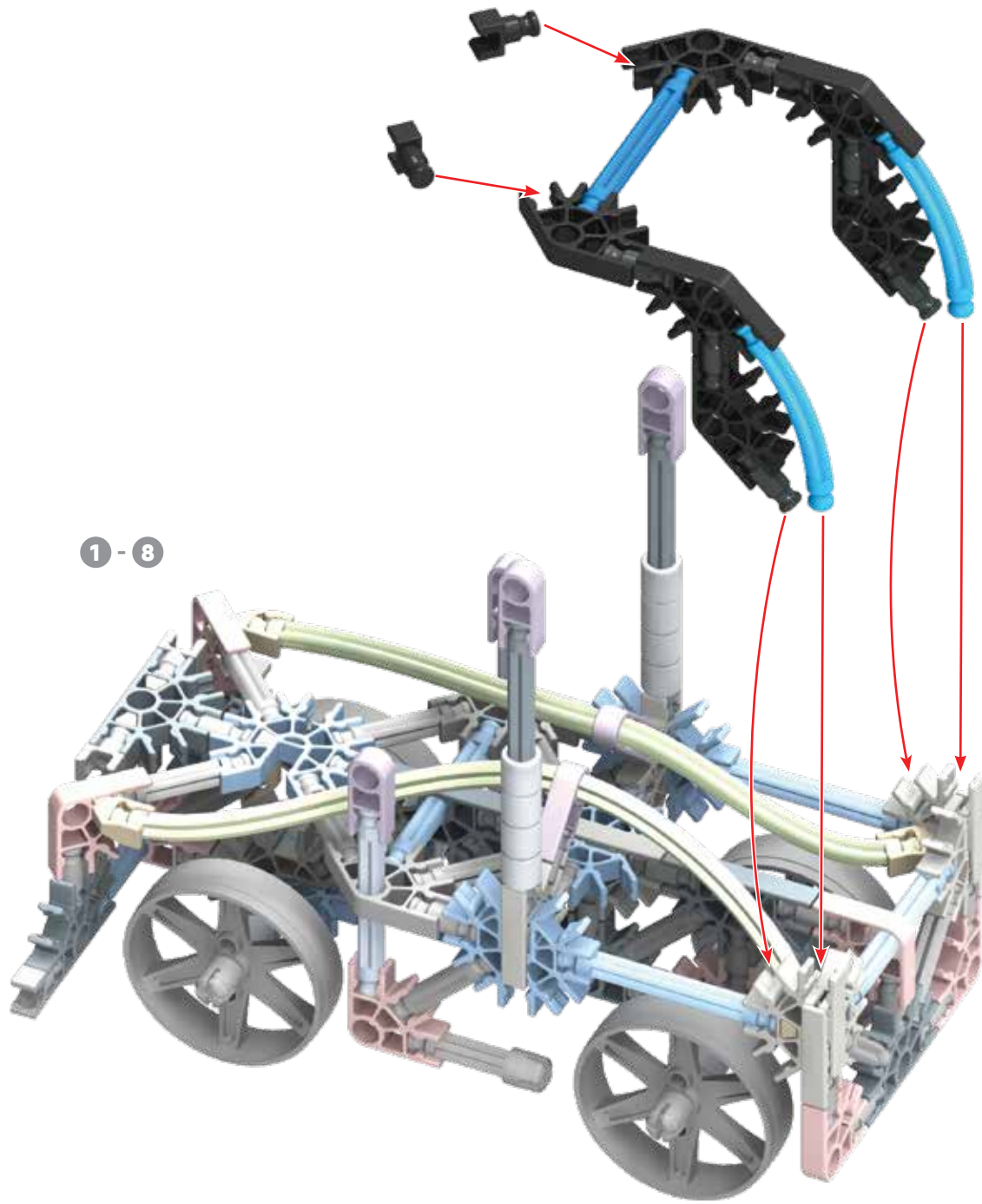

- 6 [Black Pin]
- 1 [Blue Technic Beam 1x10]
- 2 [Blue Technic Beam 1x5 Curved]
- 6 [Black Technic Connector]
- 2 [Black Technic Connector]

Big Rig

1 - 9



1

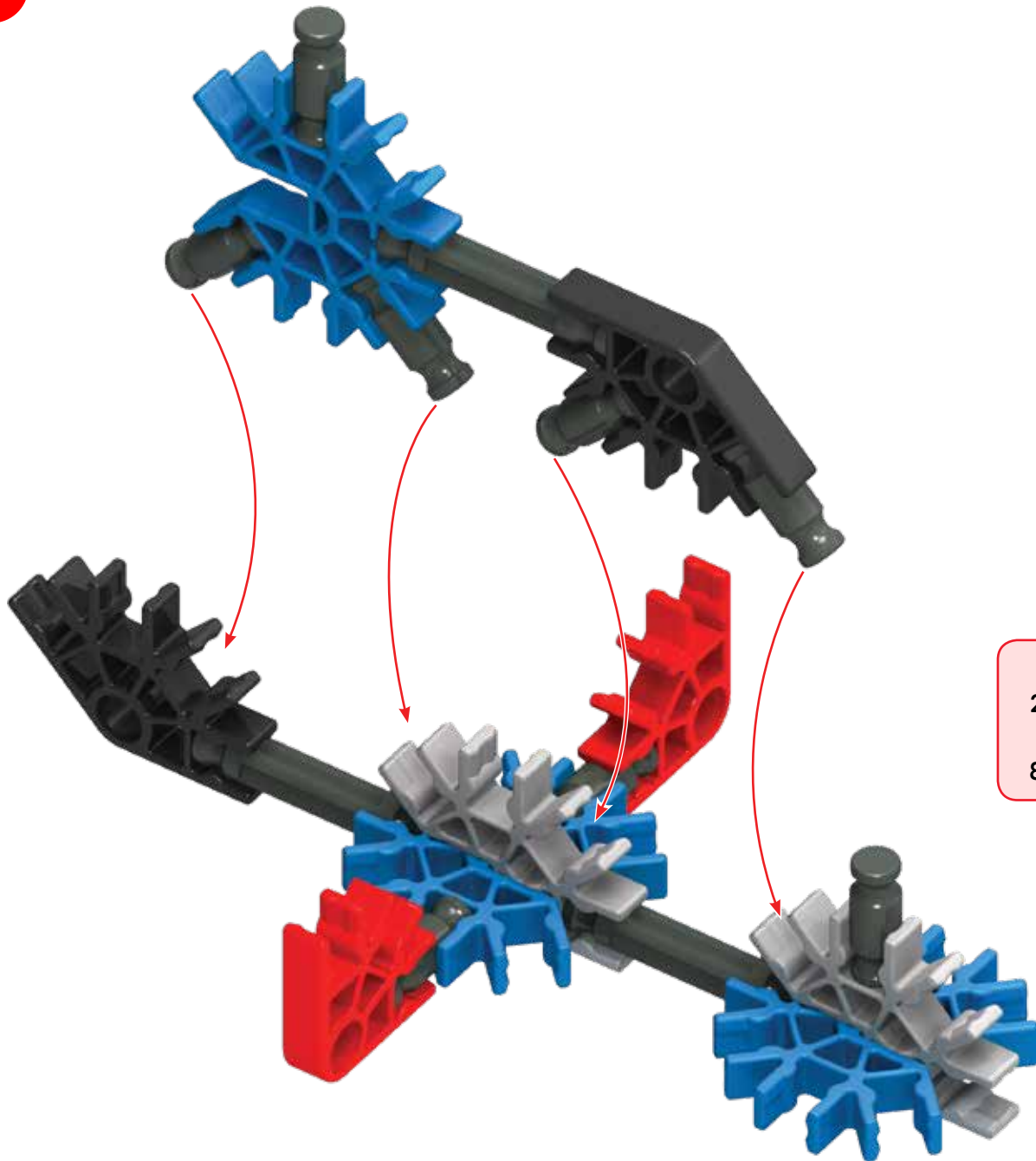

### Coupe Racer



- |   |  |   |  |   |  |   |  |
|---|--|---|--|---|--|---|--|
| 2 |  | 2 |  | 2 |  | 3 |  |
| 8 |  | 3 |  |   |  |   |  |

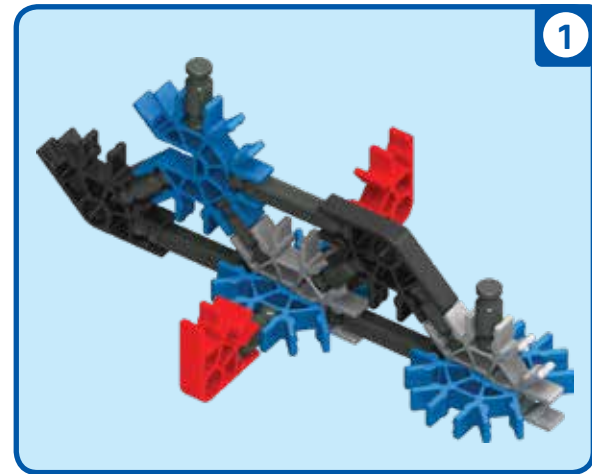

2

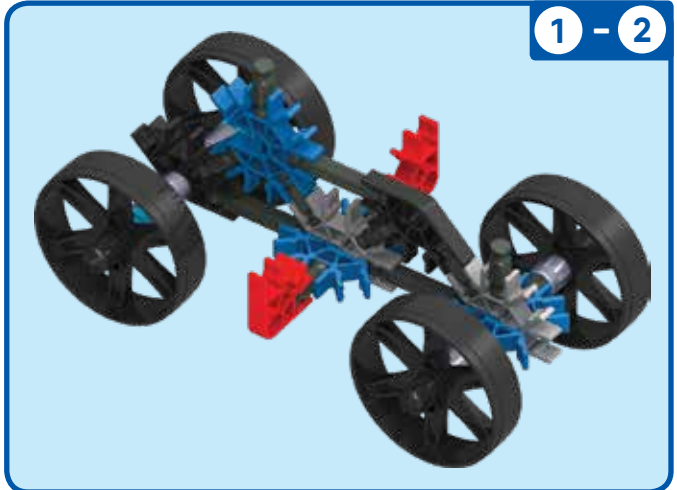
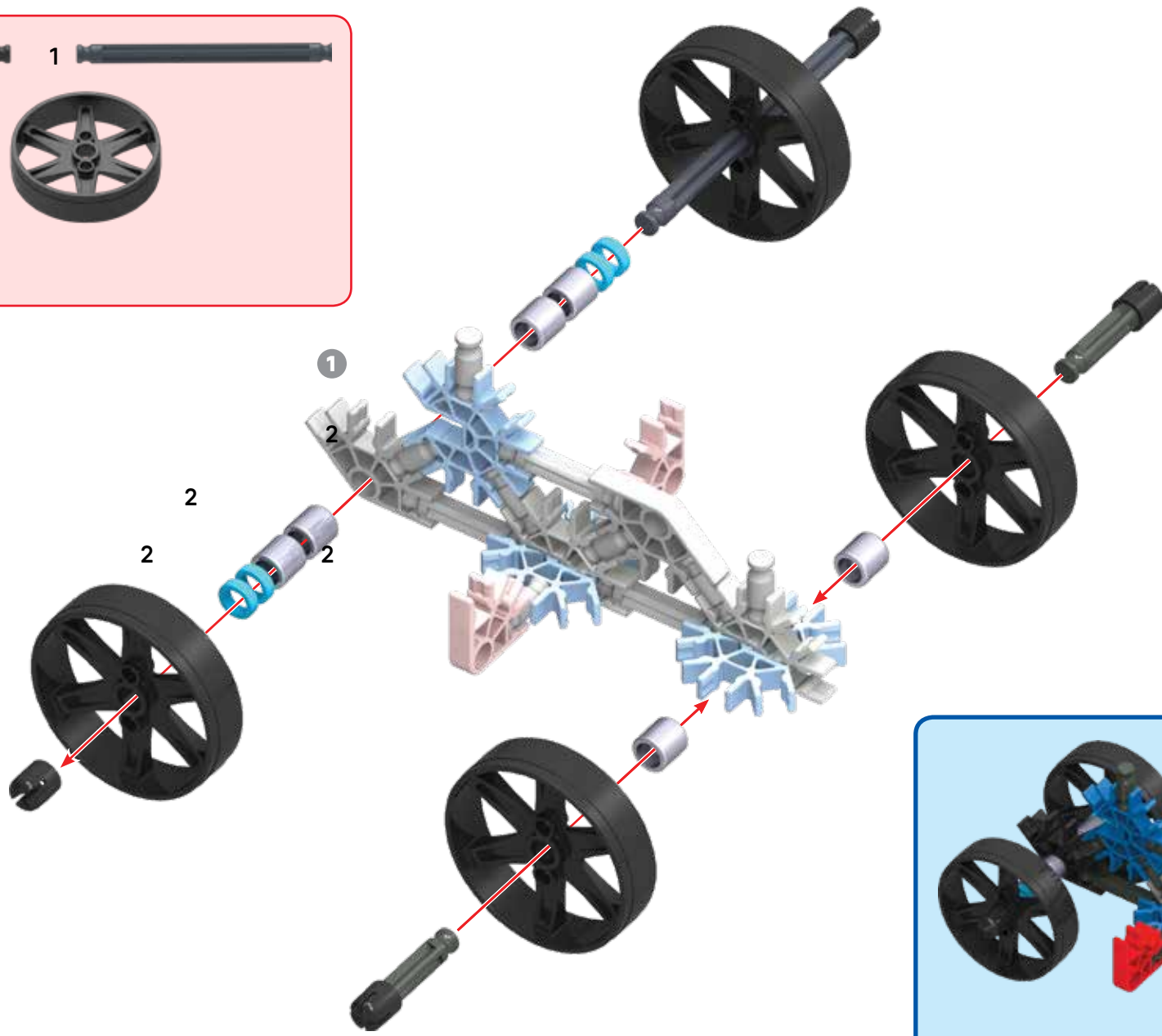
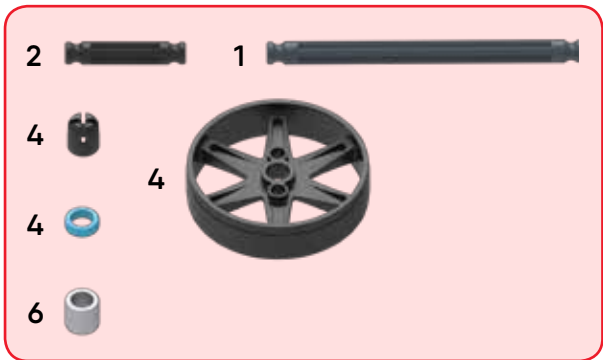

3

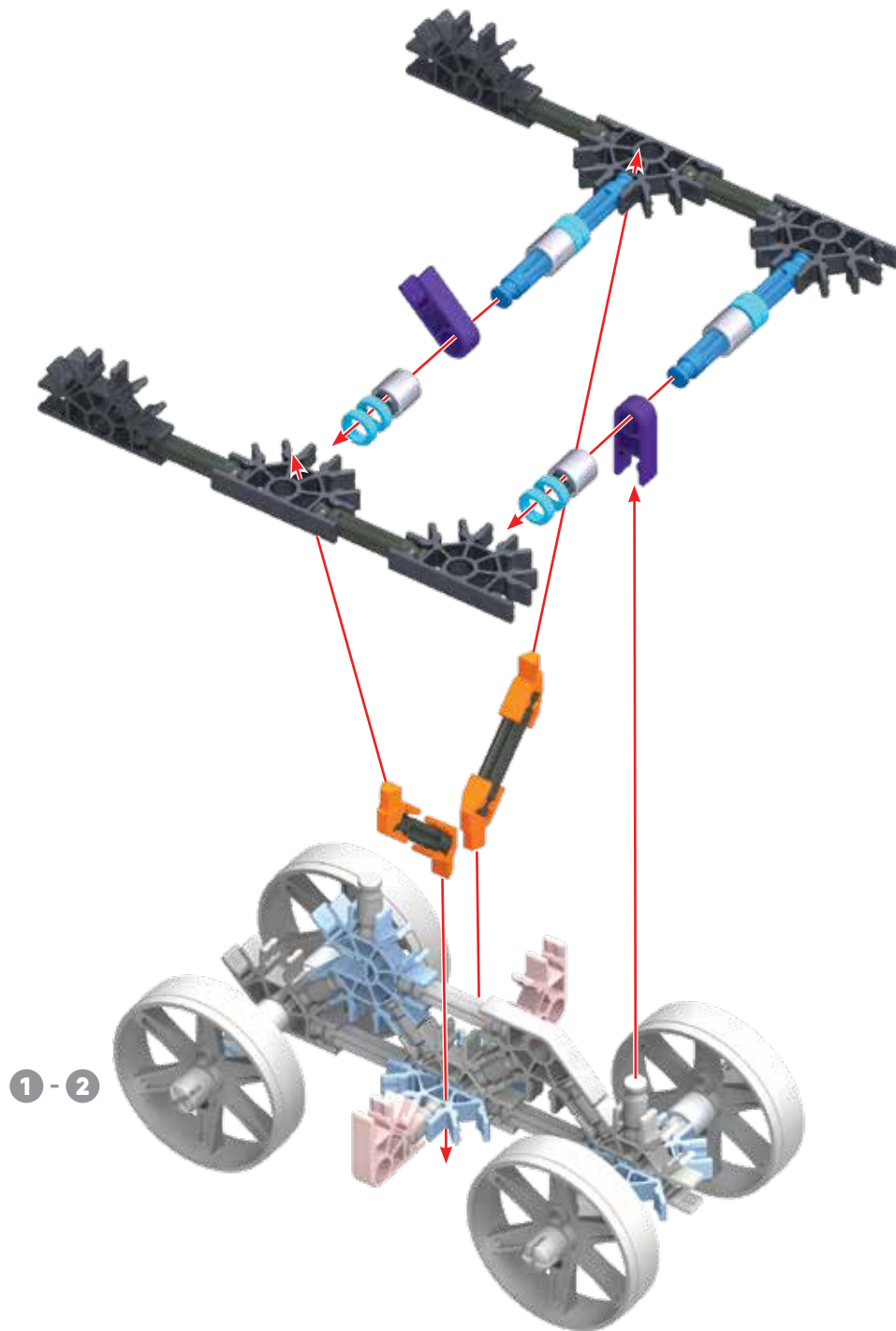

- |   |  |   |  |   |  |   |  |
|---|--|---|--|---|--|---|--|
| 6 |  | 2 |  | 4 |  | 8 |  |
| 6 |  | 2 |  | 4 |  |   |  |

1 - 2







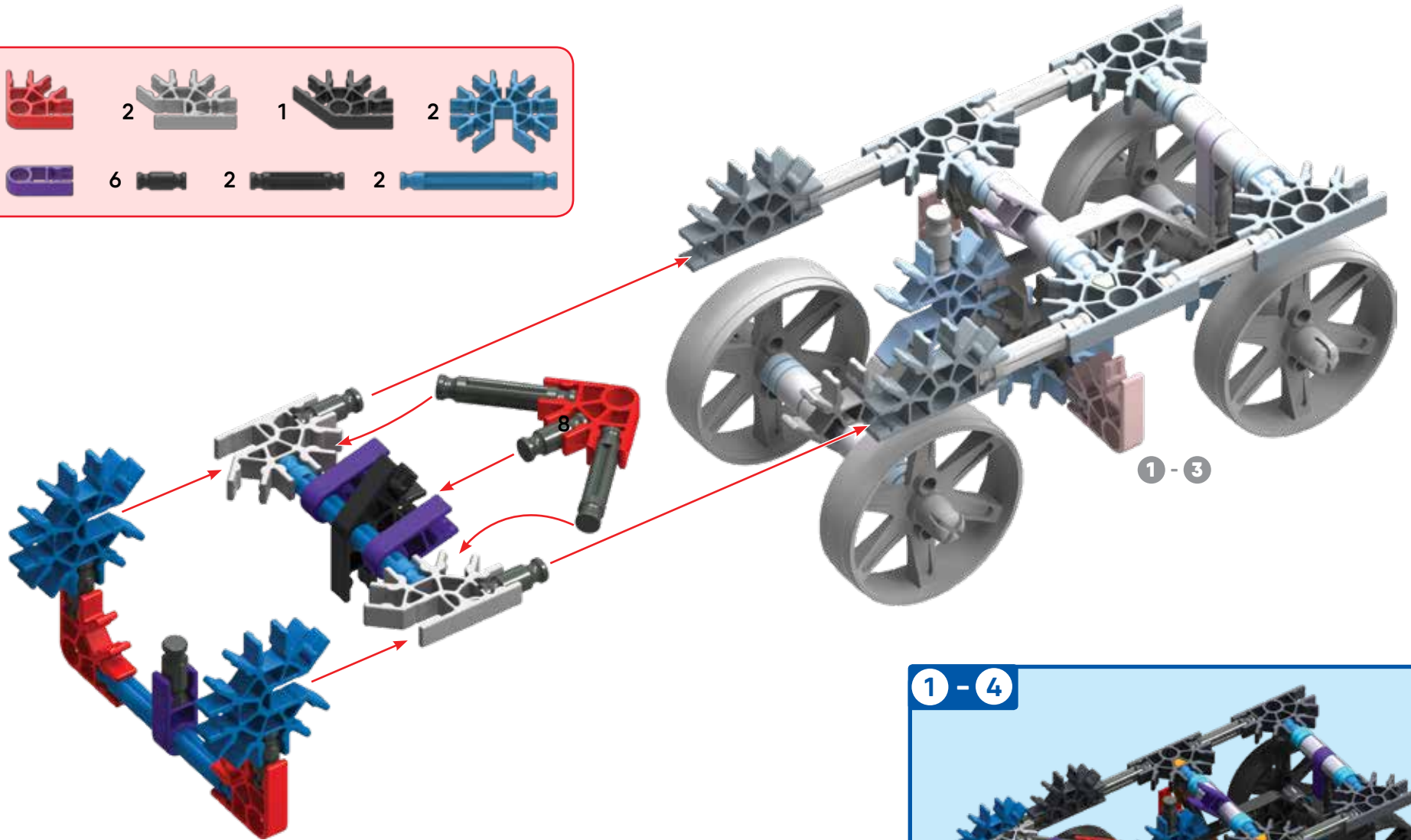

4

- 3
- 2
- 1
- 2
- 3
- 6
- 2
- 2



5

- 2 
- 4 
- 4 
- 2 
- 4 
- 2 
- 1 

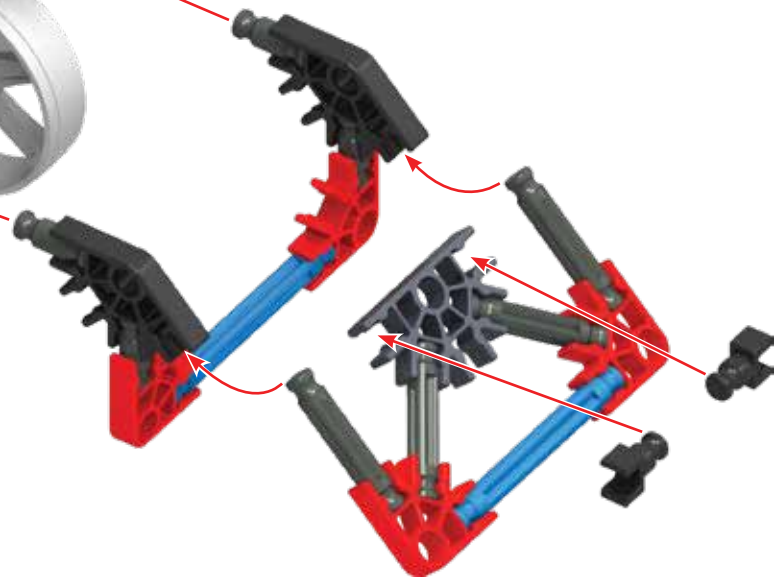
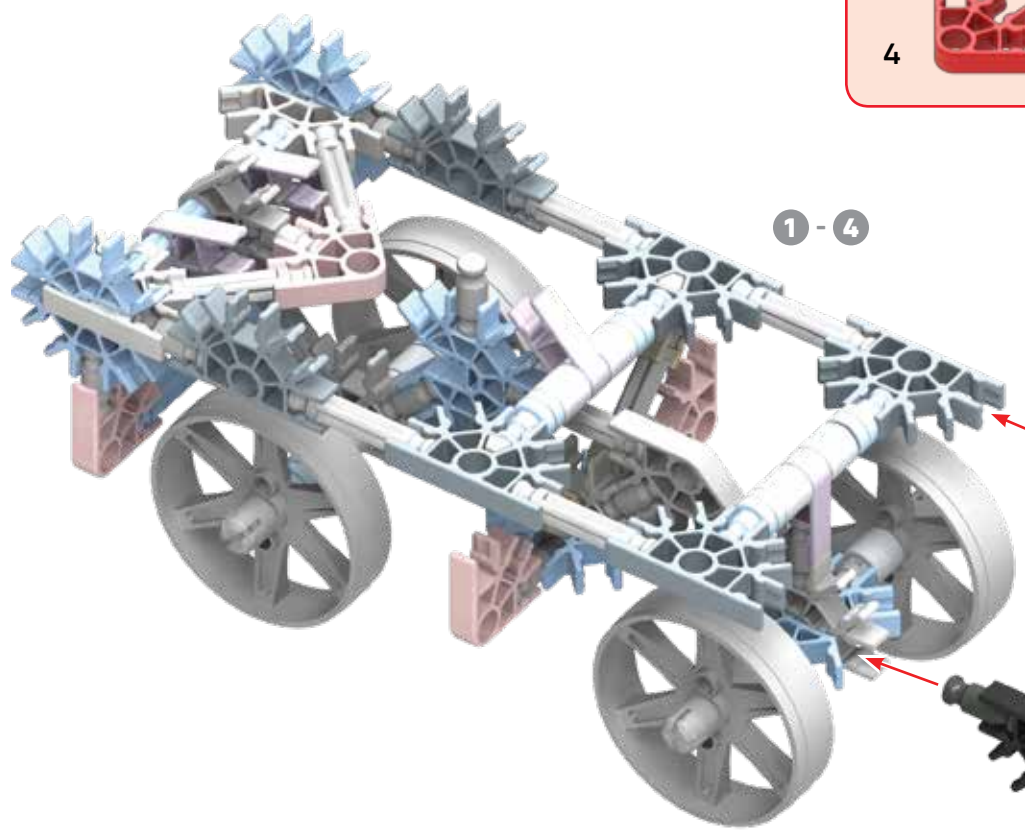

6

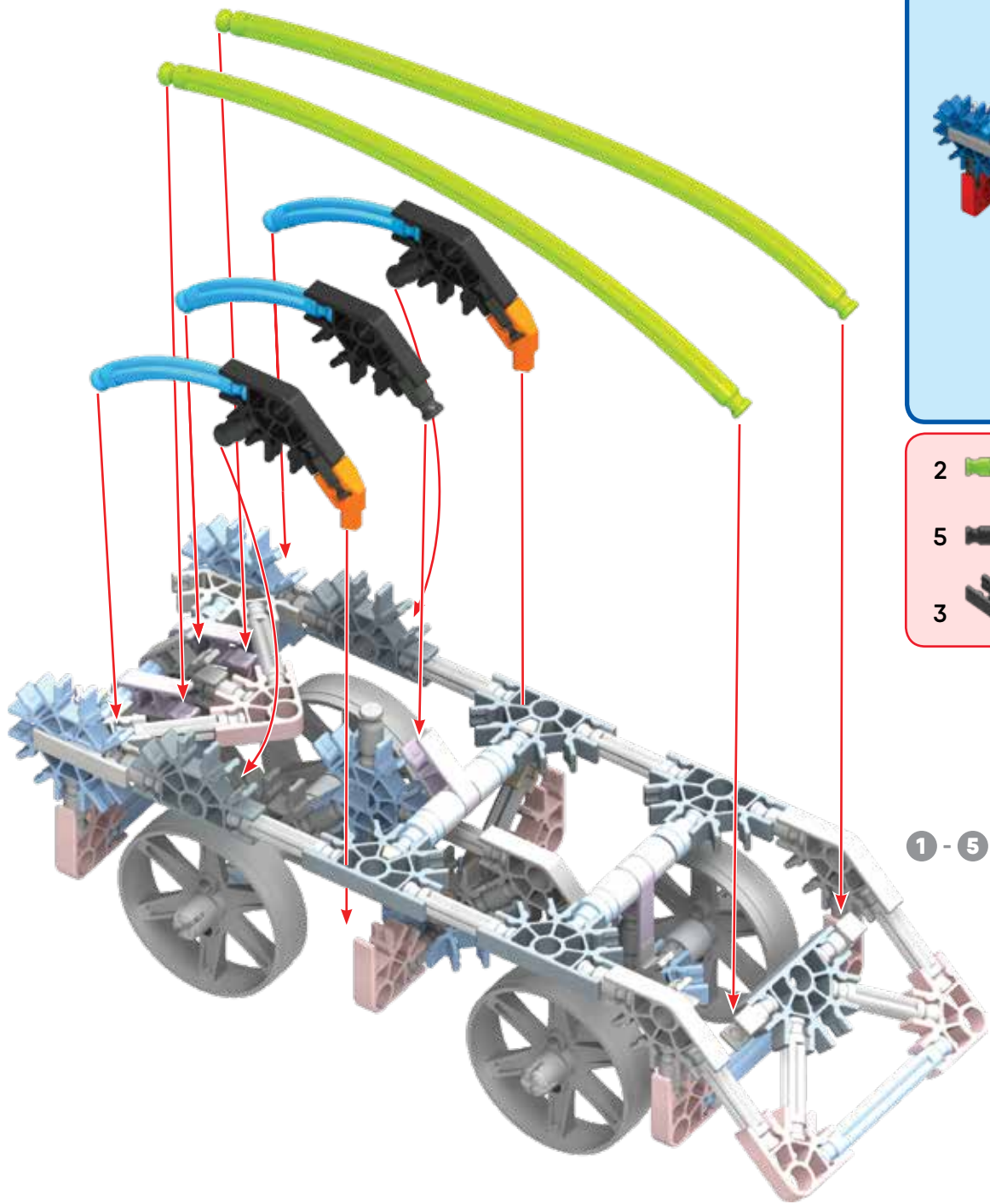

1 - 6

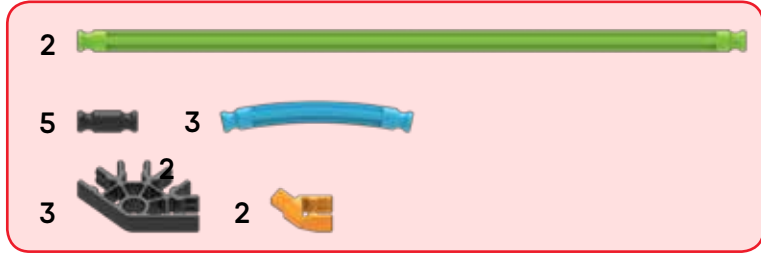

1 - 5

7

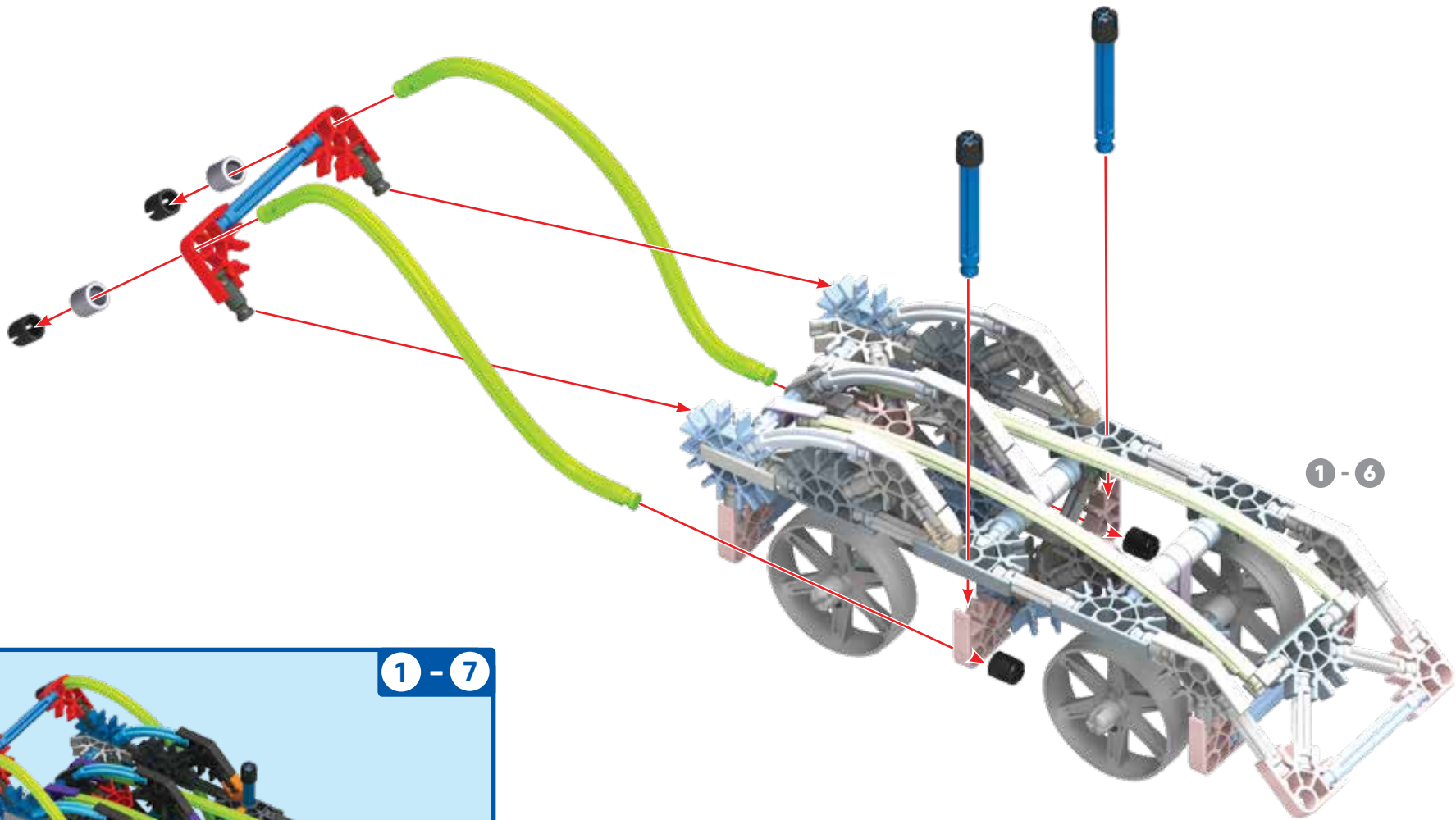

1 - 7



Coupe Racer







- 2
- 2
- 3
- 2
- 2
- 6

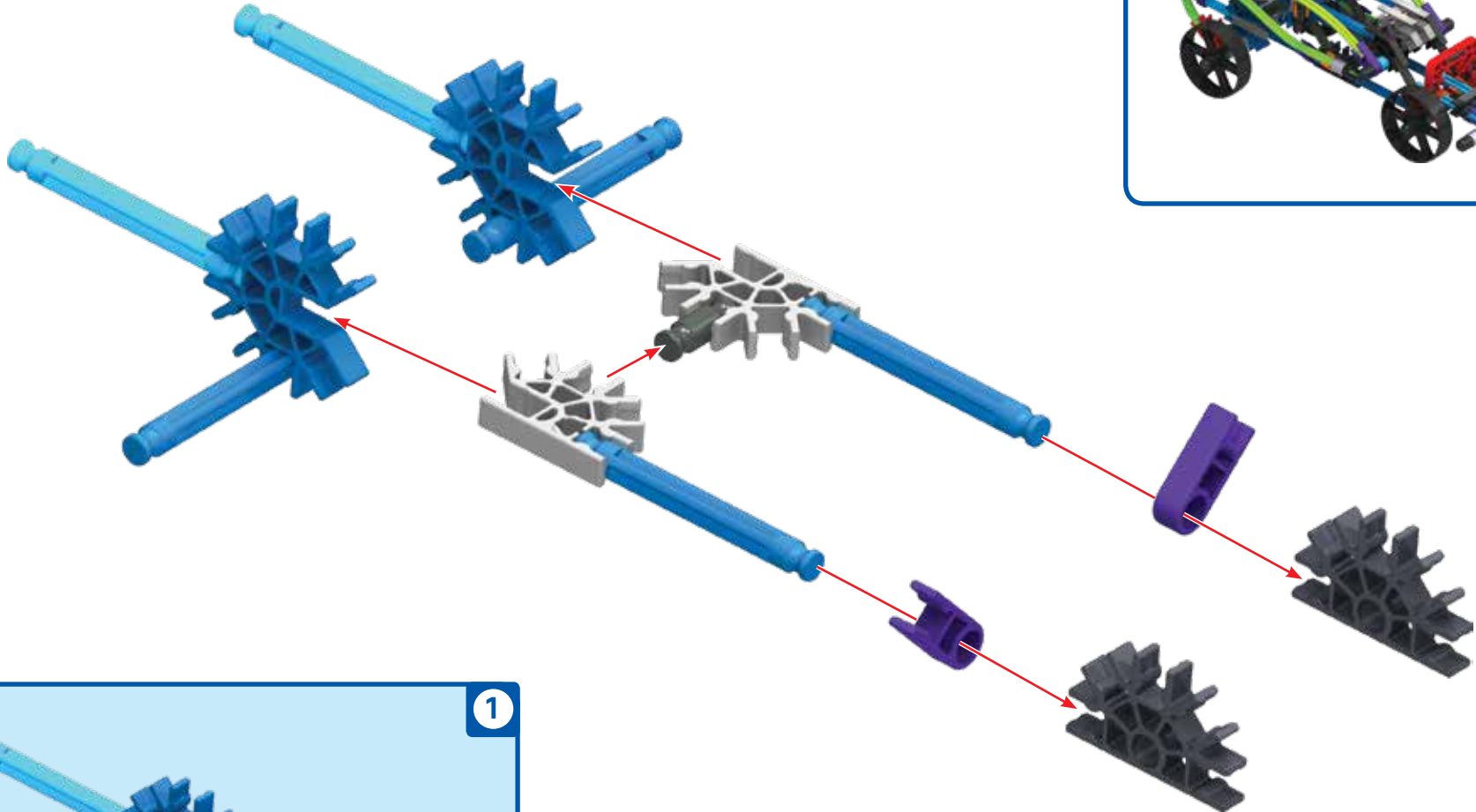

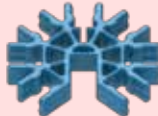
1

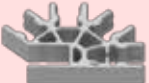
Hot Rod



- 2 
- 2 
- 2 
- 2 
- 1 
- 4 
- 2 

2

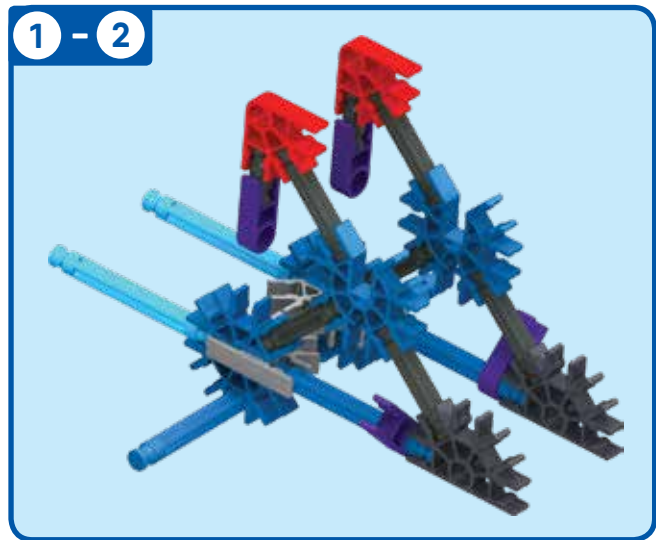
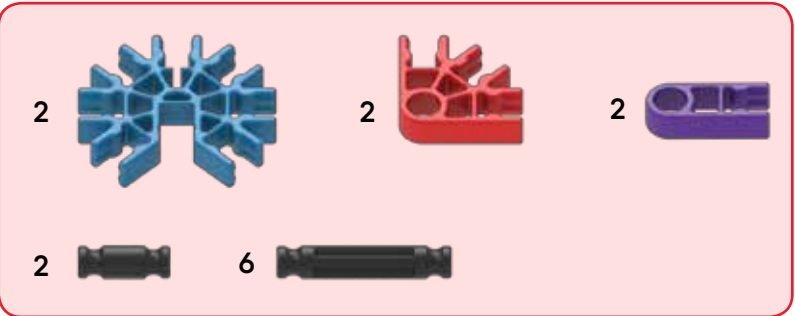
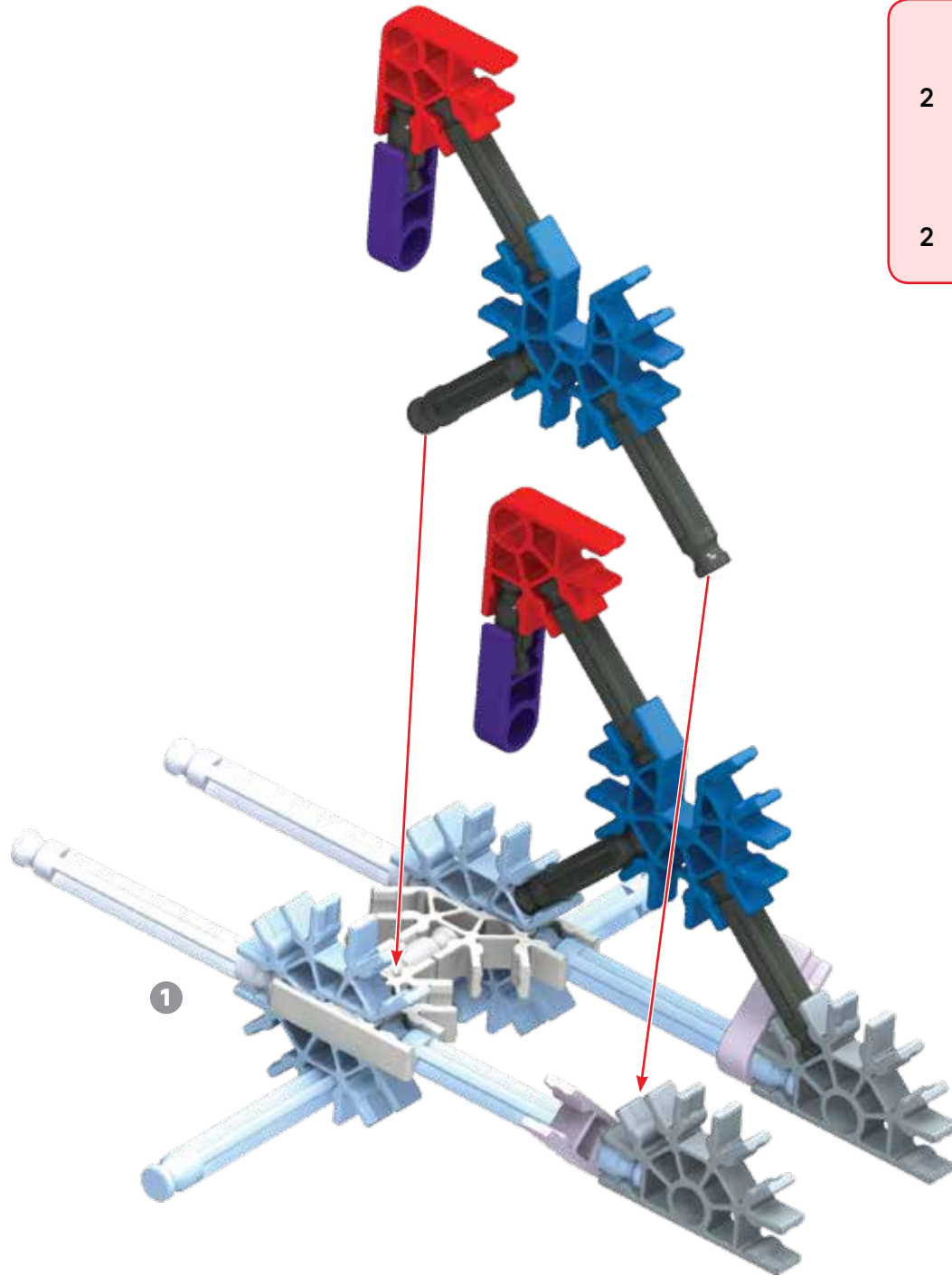

3

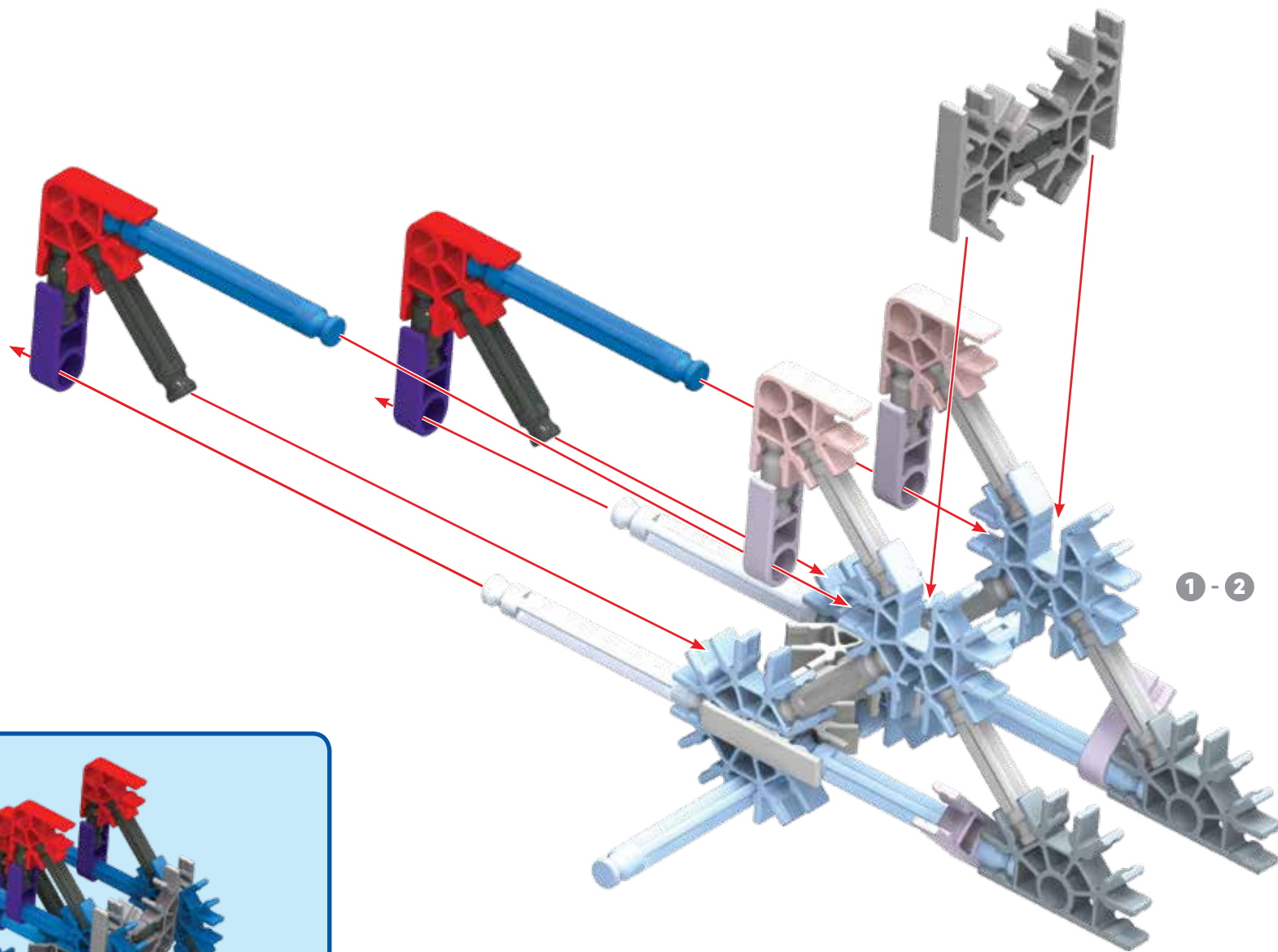

1 - 3

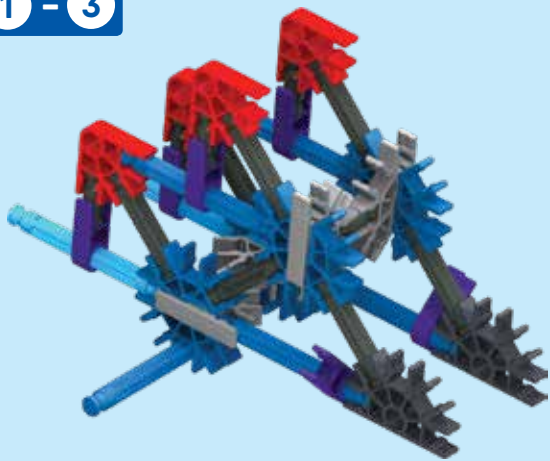

- |   |  |   |  |   |  |
|---|--|---|--|---|--|
| 3 |  | 2 |  | 2 |  |
| 2 |  | 2 |  | 2 |  |

4

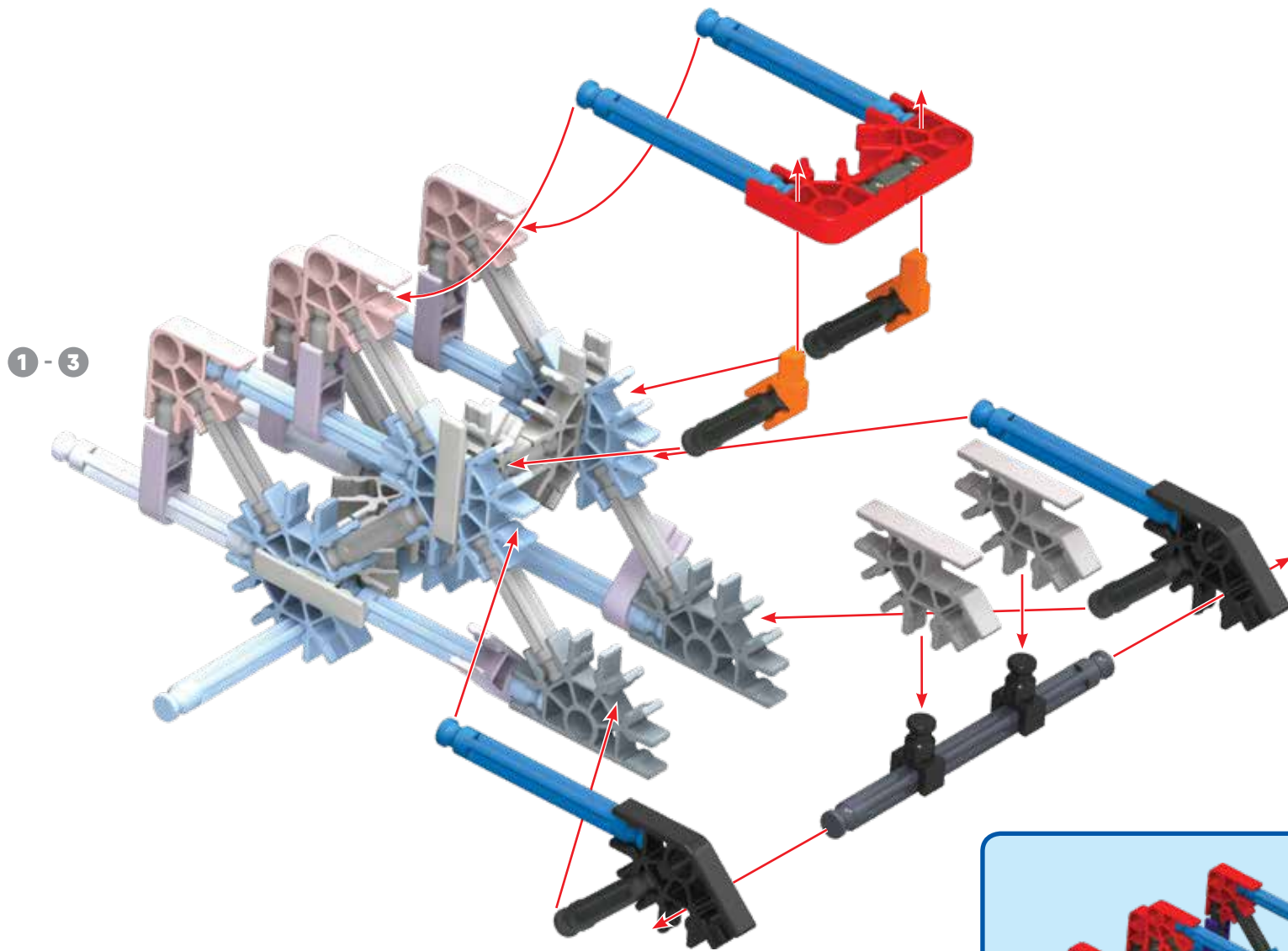

- 2
- 2
- 2
- 2
- 2
- 1
- 4
- 4
- 1

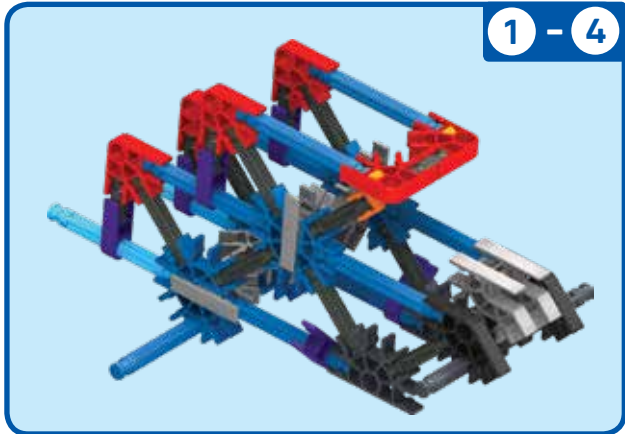





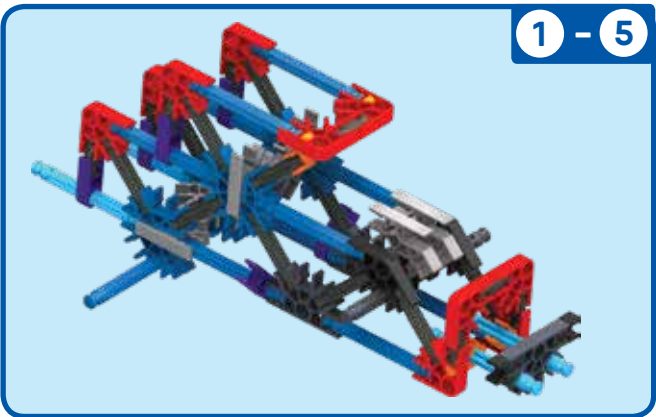
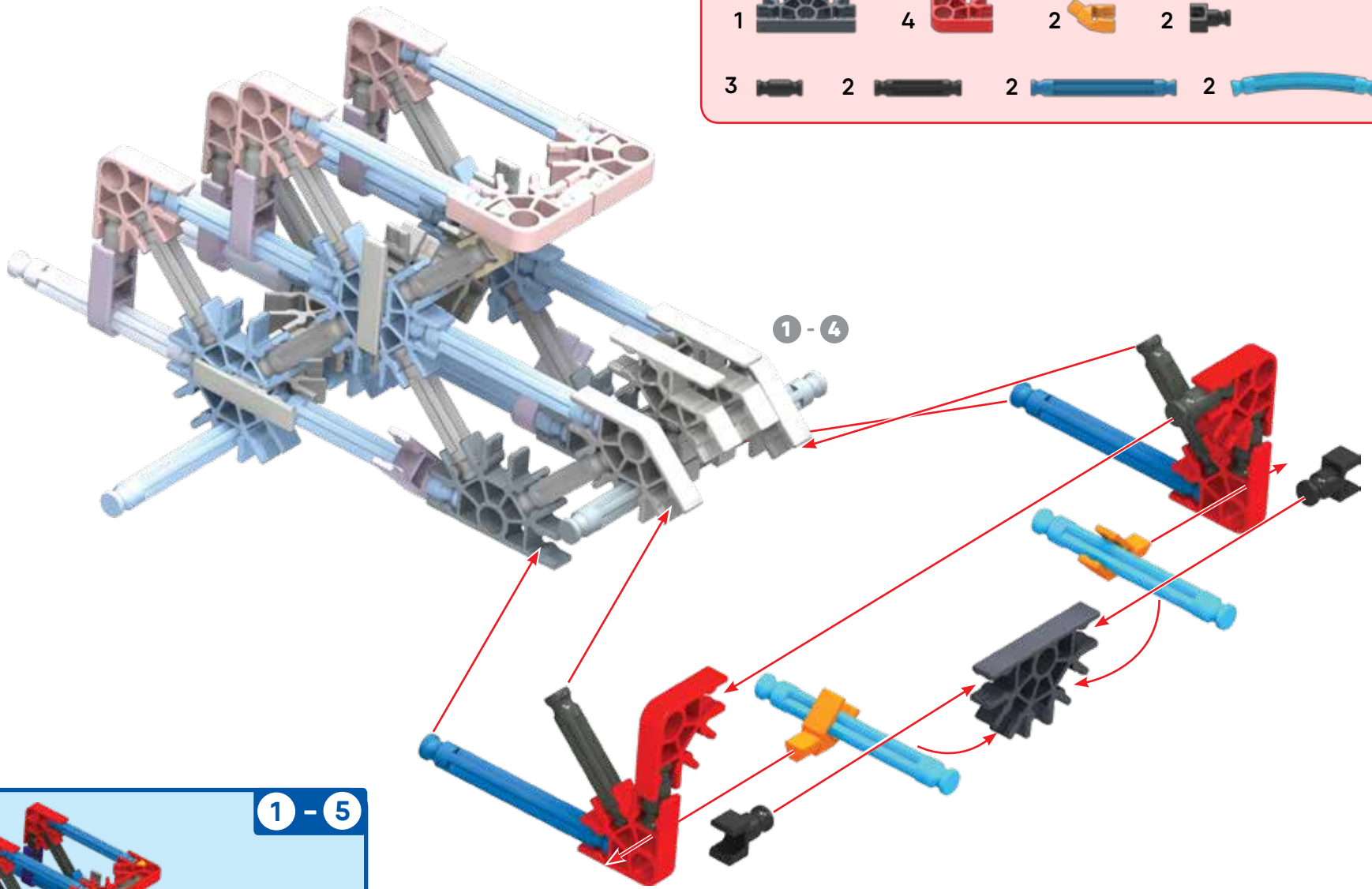



5

- 1
- 4
- 2
- 2
- 3
- 2
- 2
- 2



6

- 4 
- 2 
- 4 
- 5 
- 2 
- 2 
- 2 
- 1 

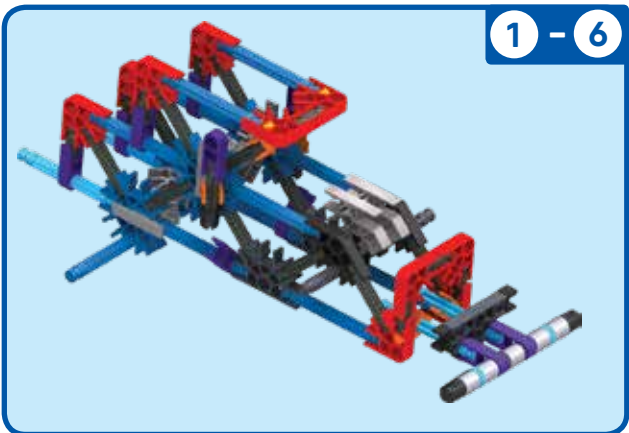
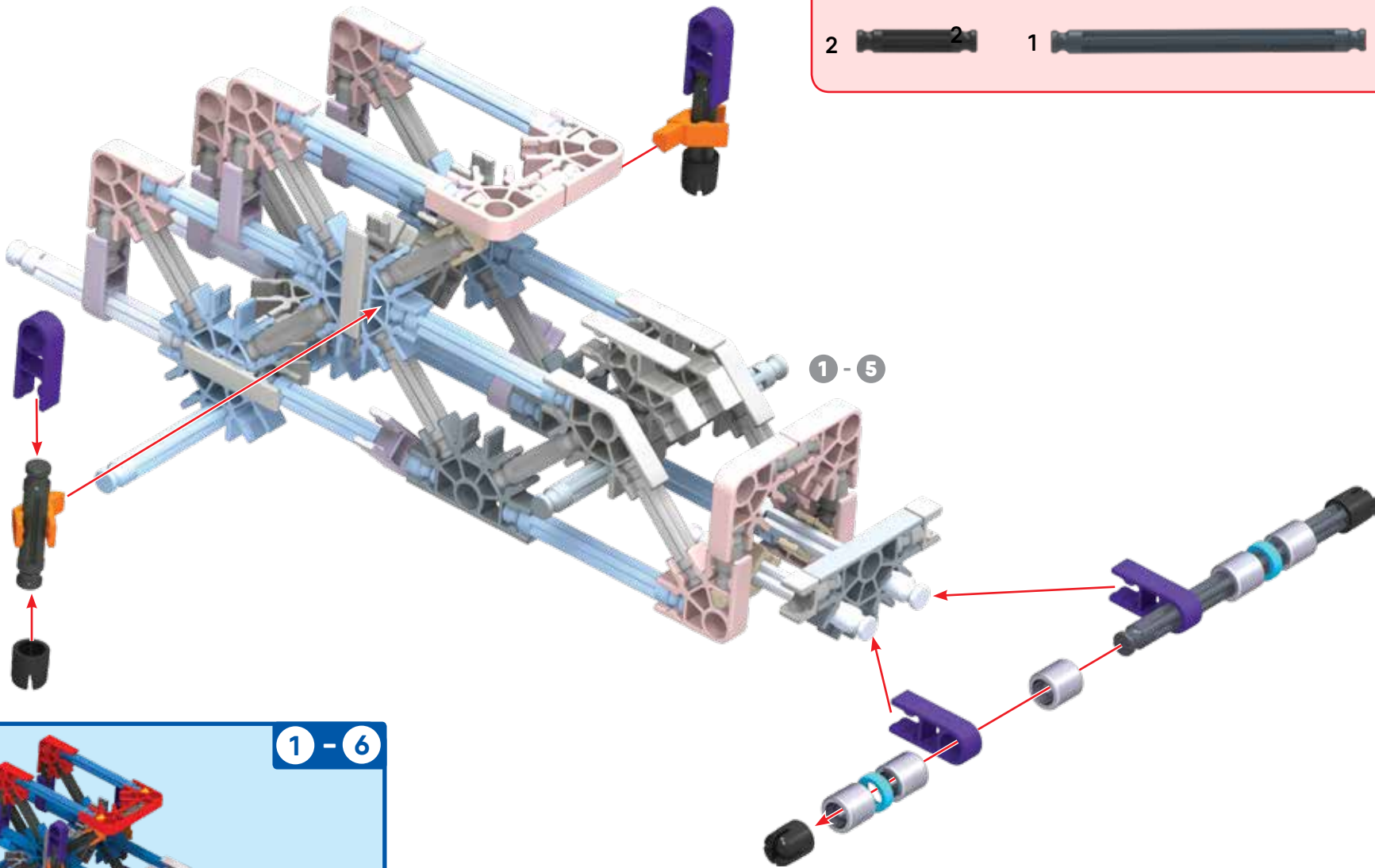

7

Rotate model

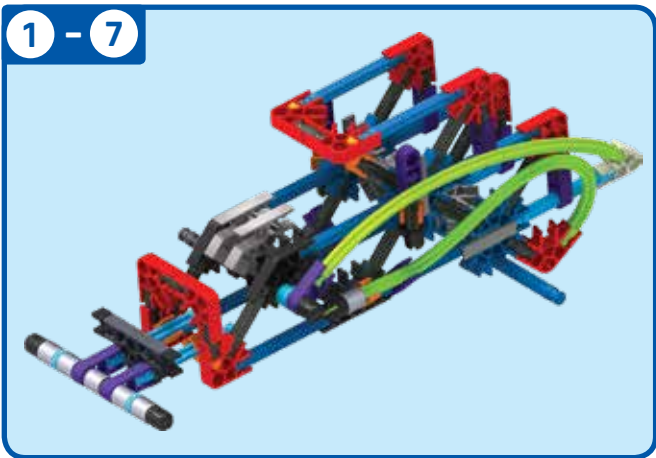
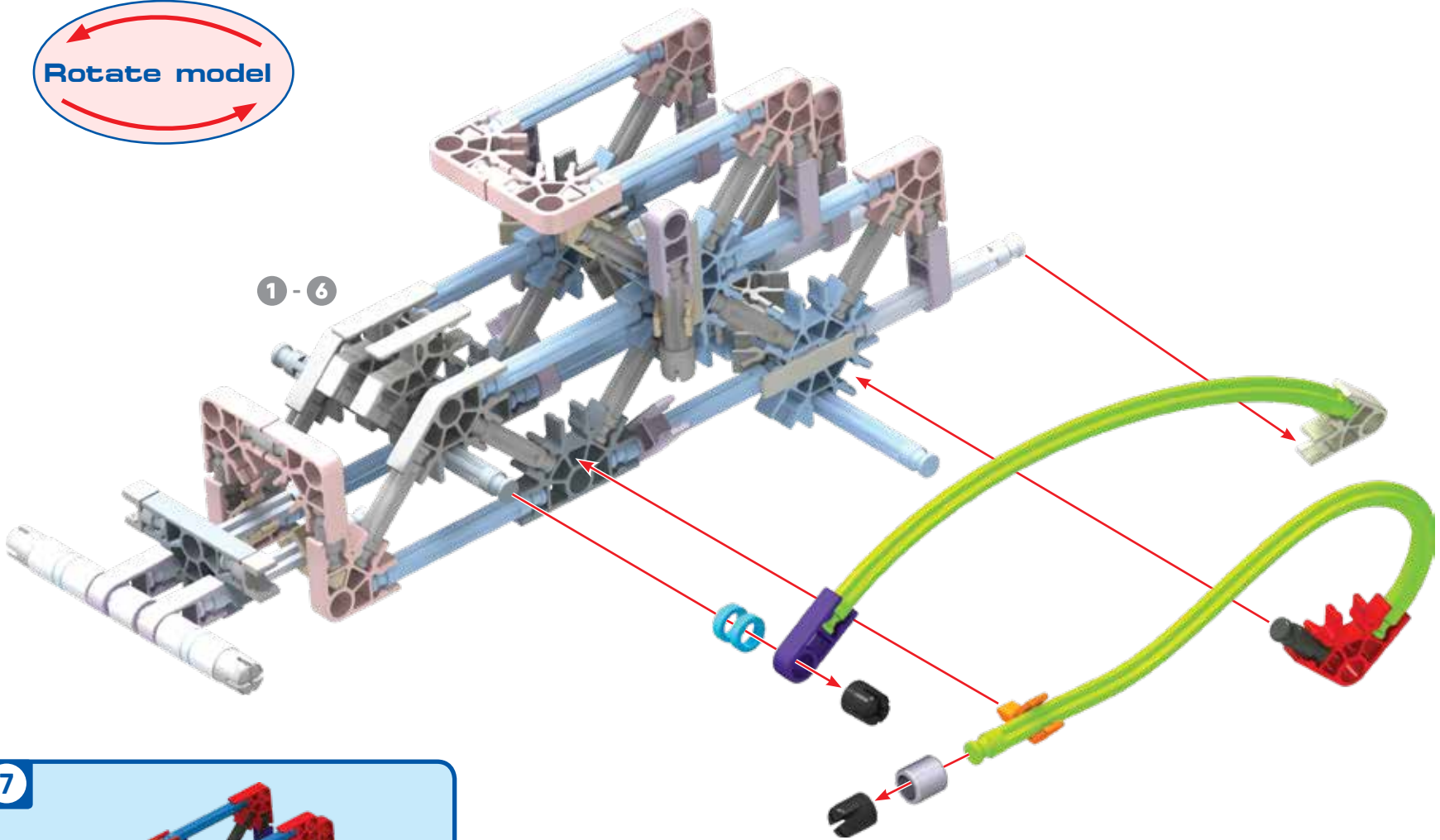

- |   |  |   |  |   |  |   |  |
|---|--|---|--|---|--|---|--|
| 2 |  |   |  |   |  |   |  |
| 1 |  | 1 |  | 1 |  | 1 |  |
| 1 |  | 1 |  | 2 |  | 2 |  |

8

Rotate model

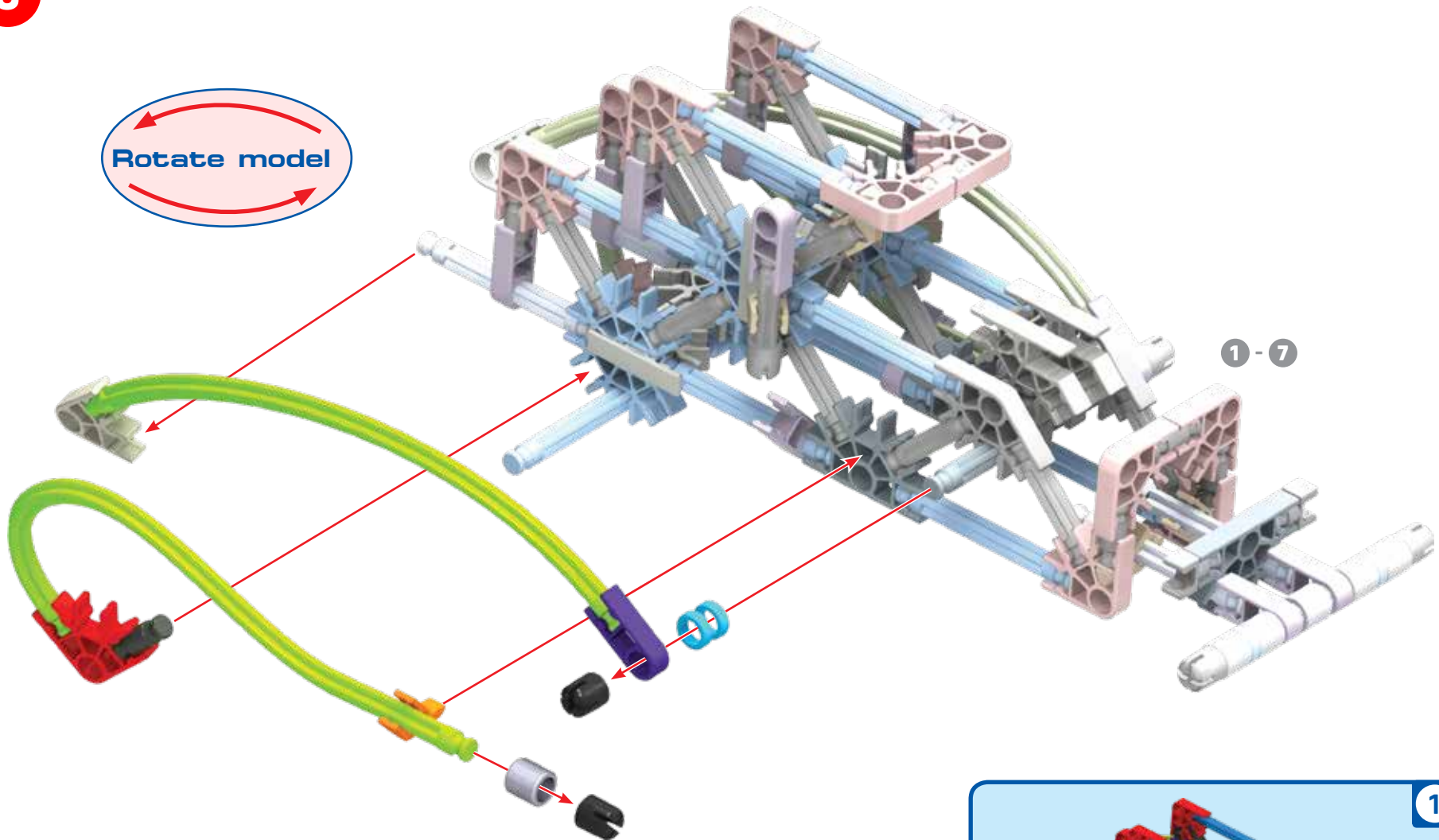

- 2 Green Technic beam
- 1 Red Technic connector
- 1 Grey Technic connector
- 1 Purple Technic connector
- 1 Yellow Technic connector
- 1 Black Technic pin
- 1 Grey Technic bush
- 2 Black Technic pins
- 2 Blue Technic rings

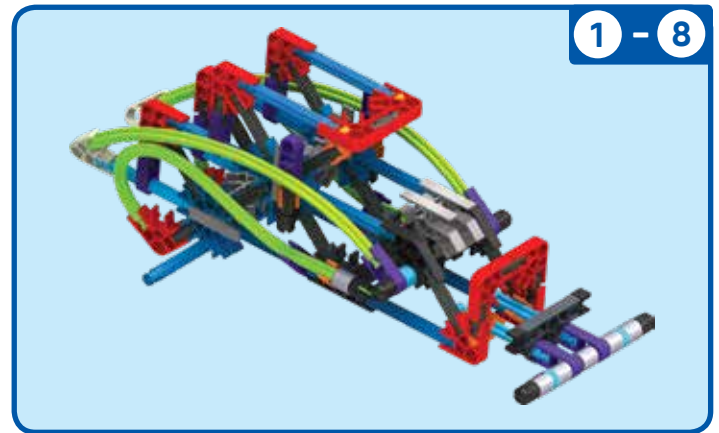



9

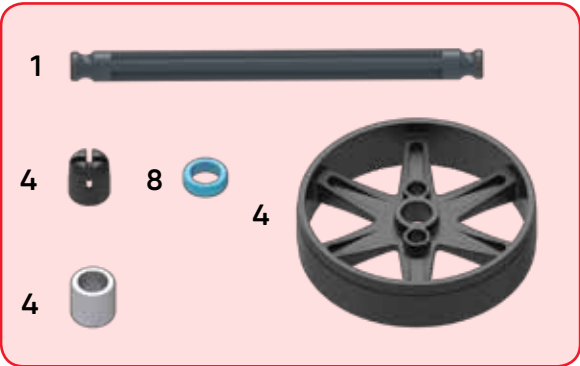
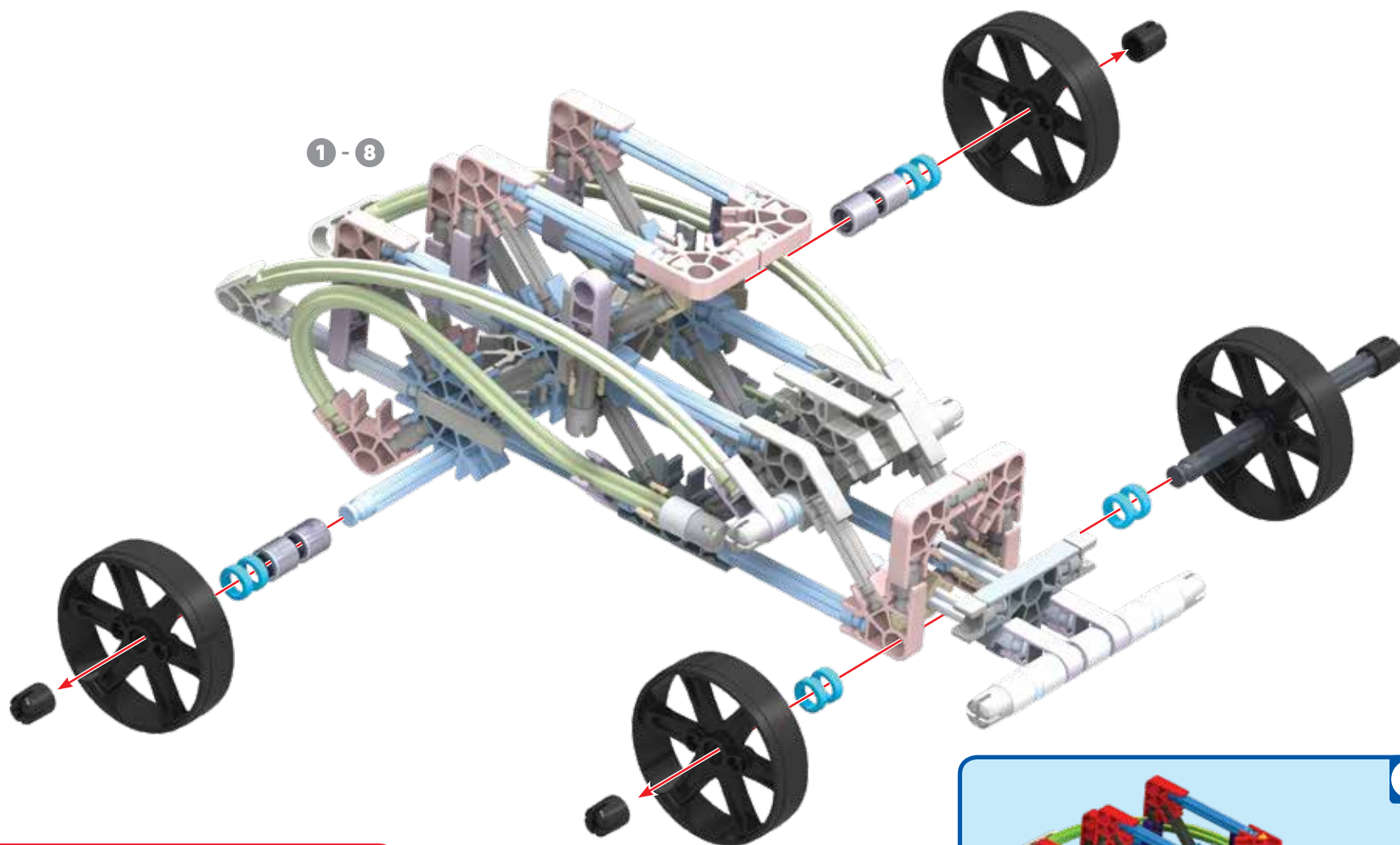

1

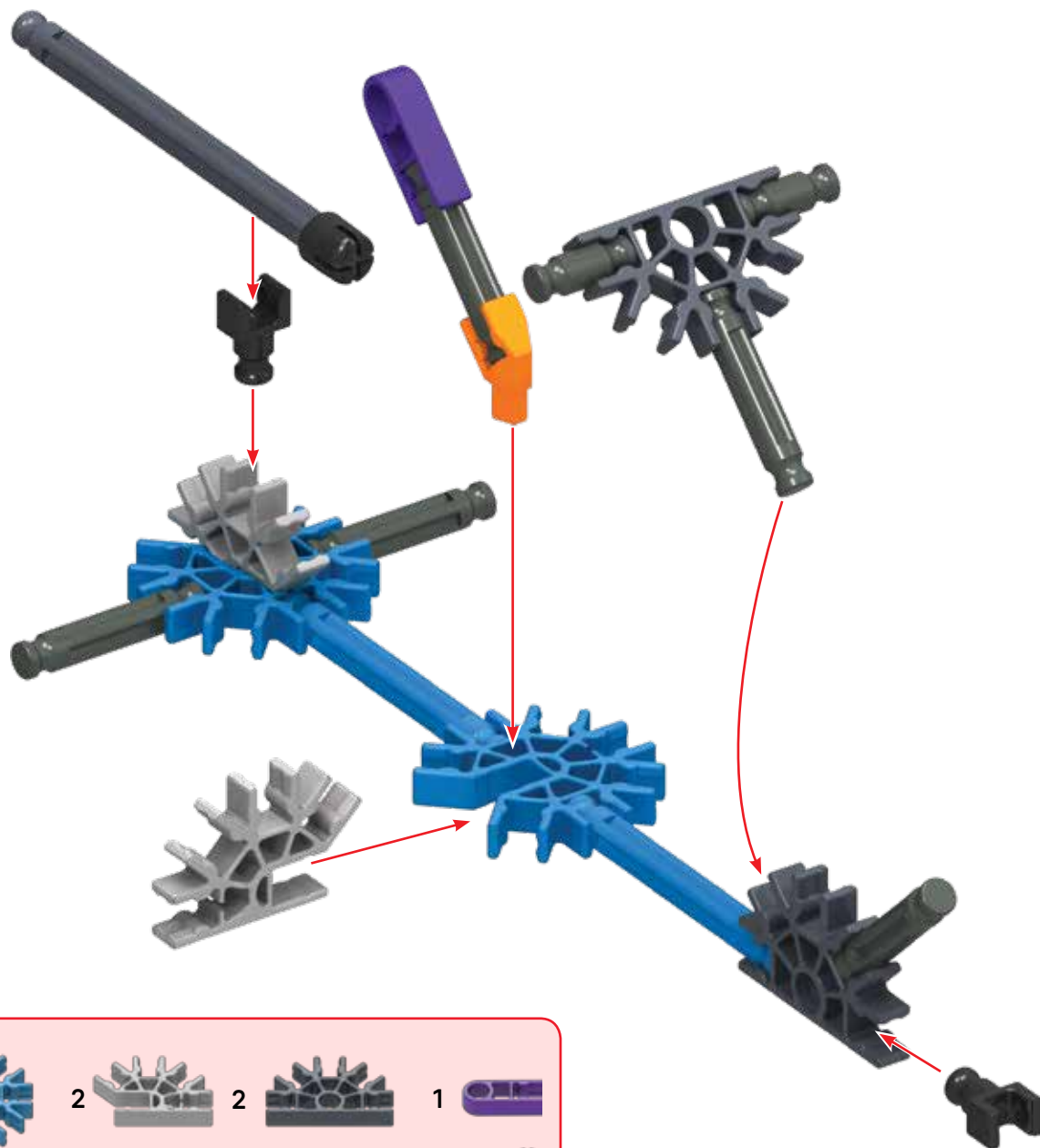

Amphibious Vehicle

- |   |  |   |  |   |  |   |  |
|---|--|---|--|---|--|---|--|
| 2 |  | 2 |  | 2 |  | 1 |  |
| 2 |  | 5 |  | 2 |  | 1 |  |
| 1 |  | 1 |  | 2 |  |   |  |



2

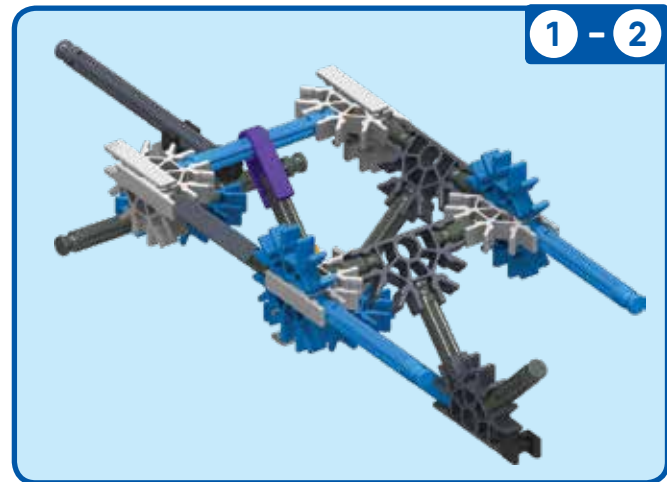
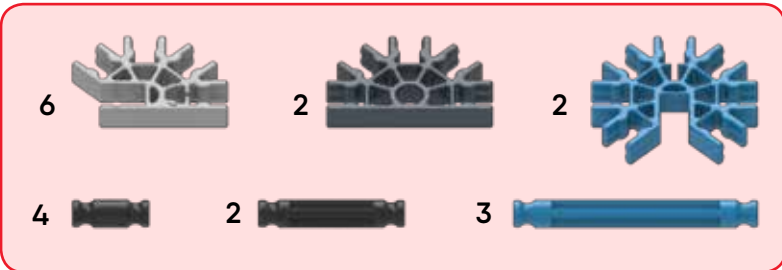
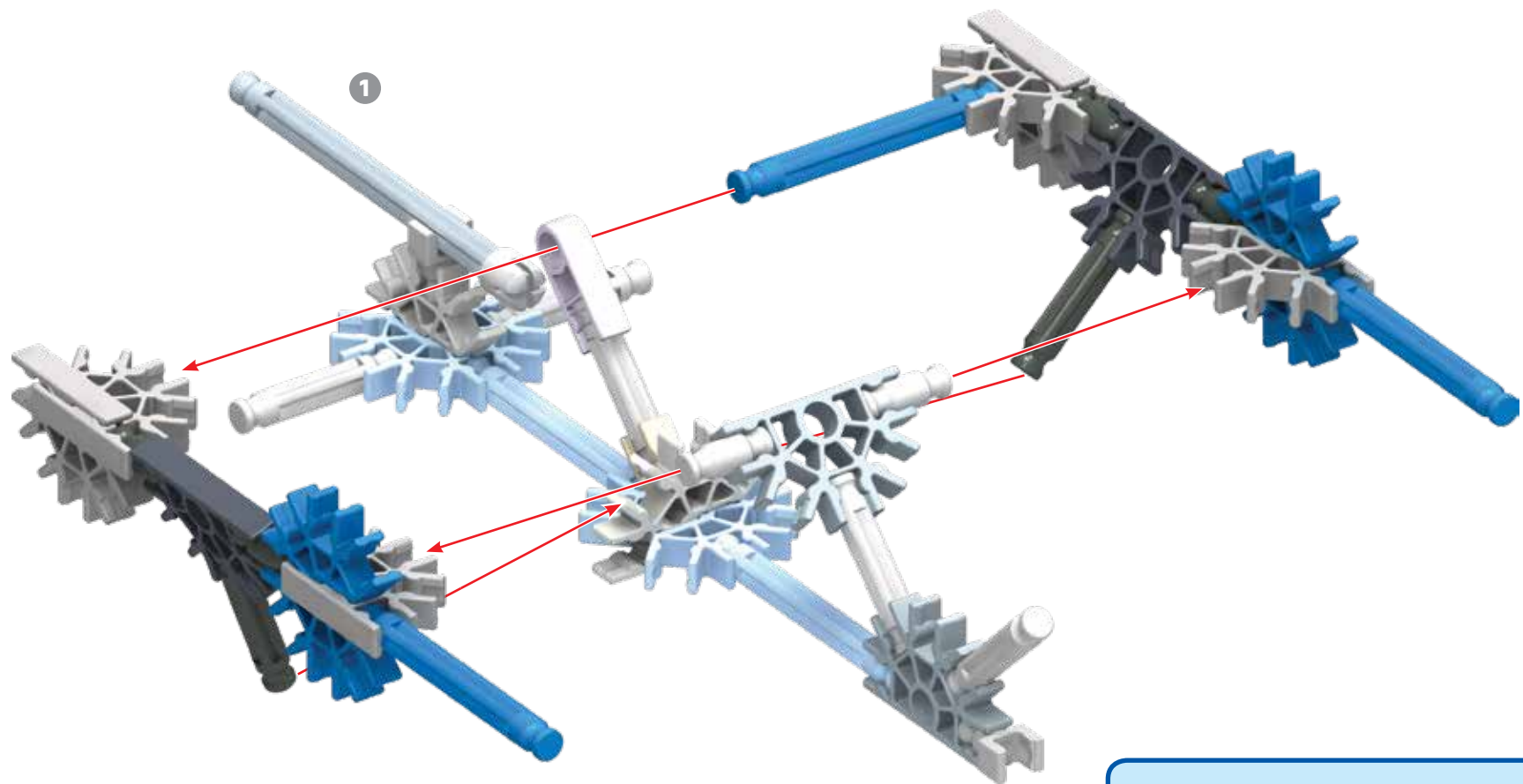

3

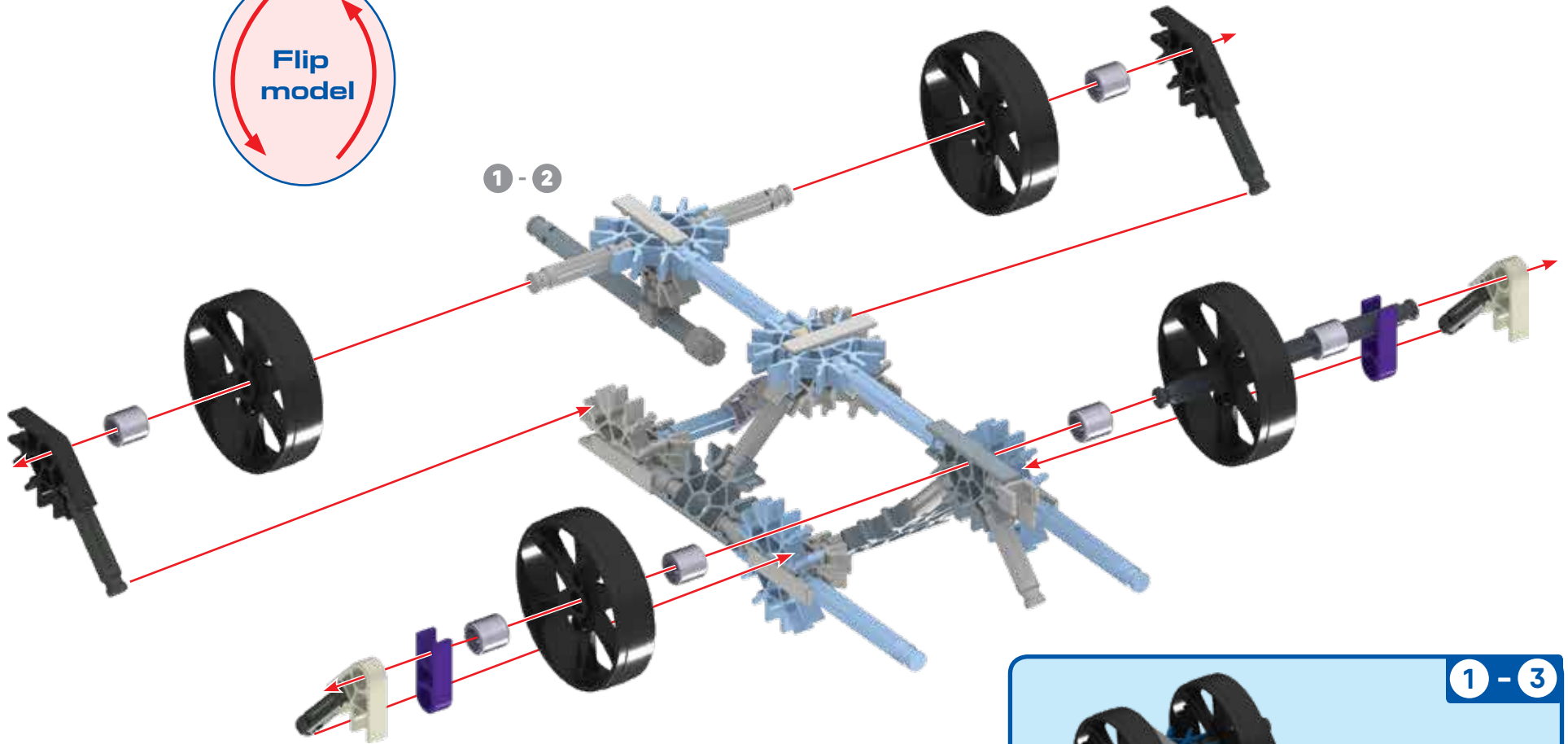
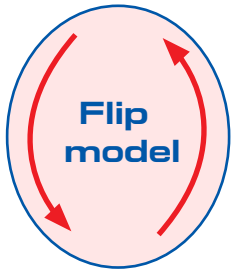

1 - 2



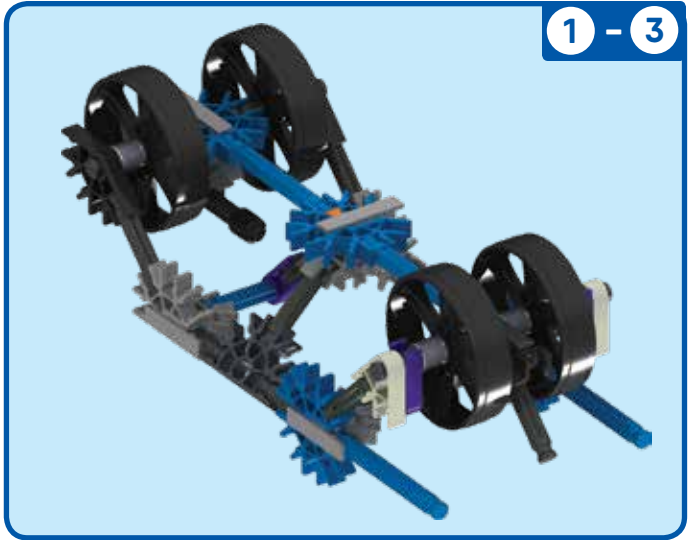
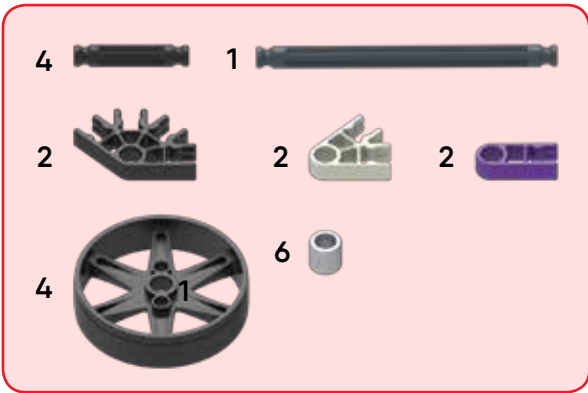

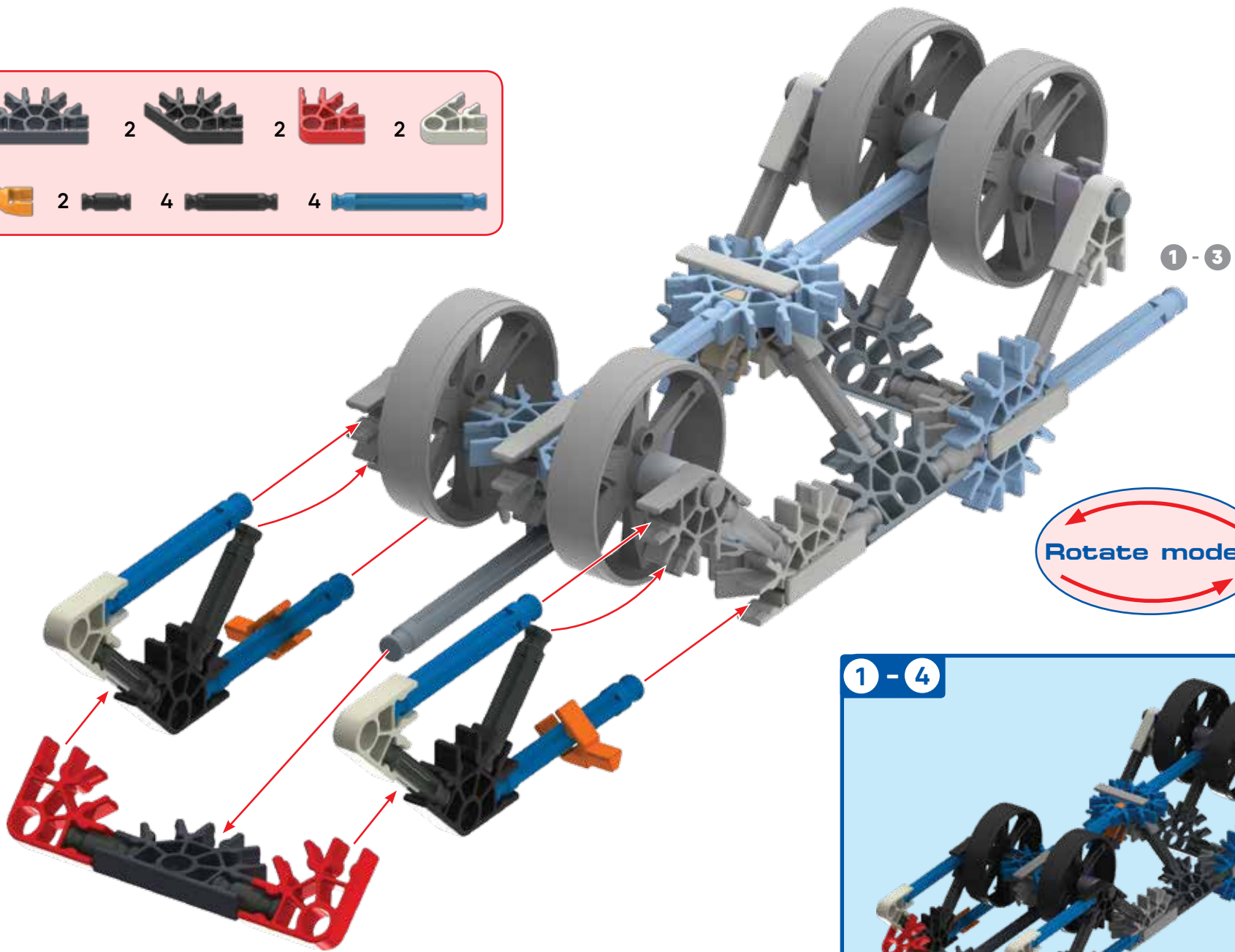
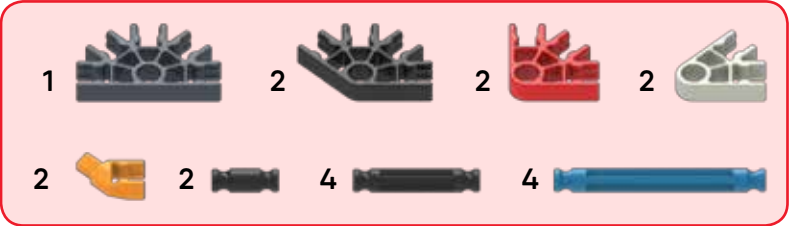

1 - 3



4



5

- 1 
- 2 
- 5 
- 4 
- 6 
- 2 
- 2 

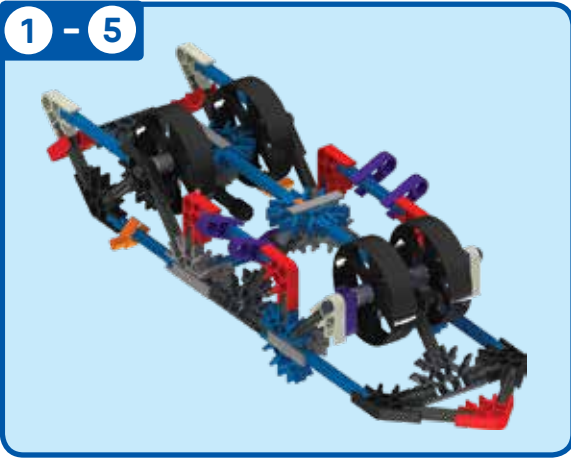
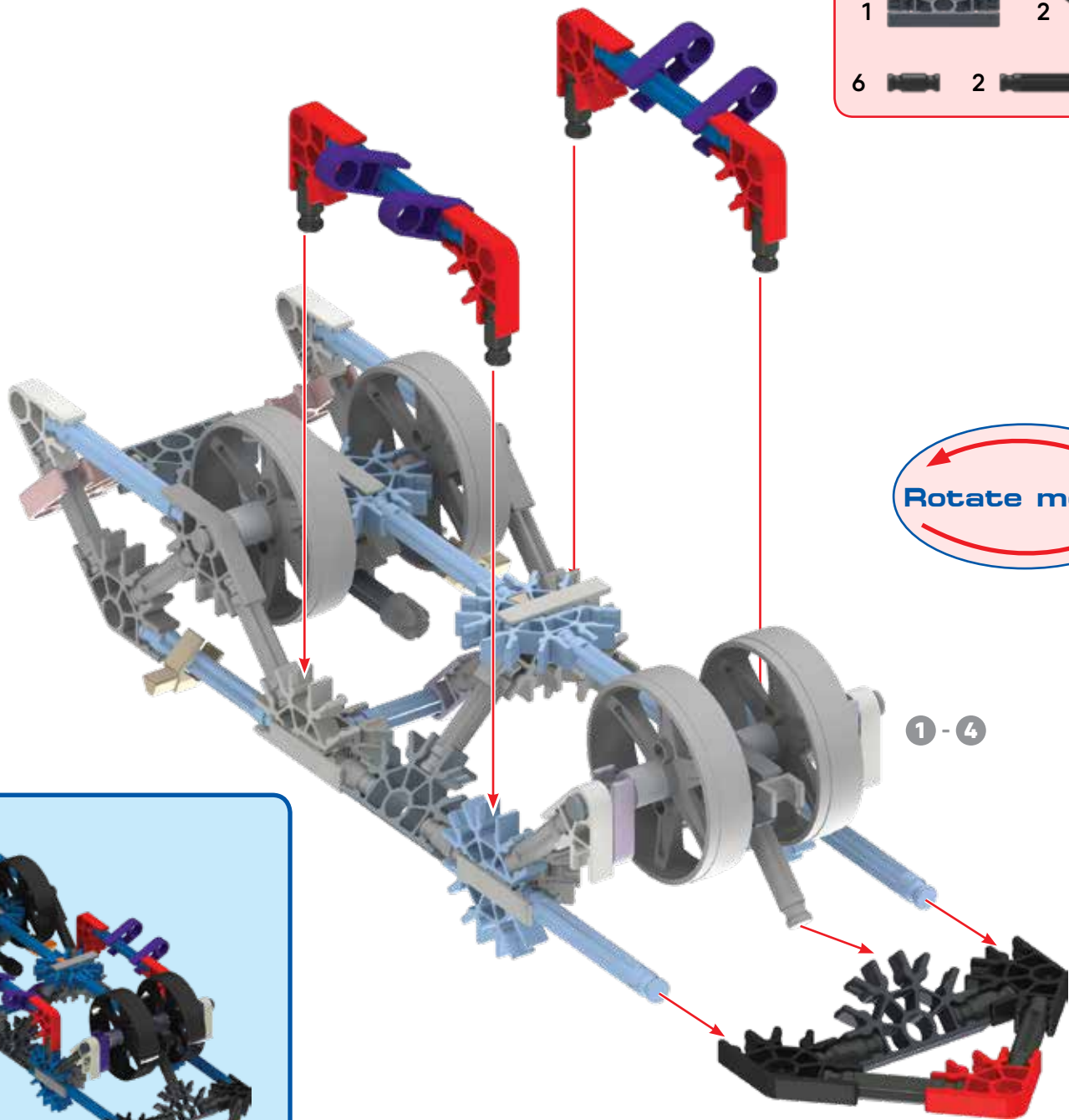

6

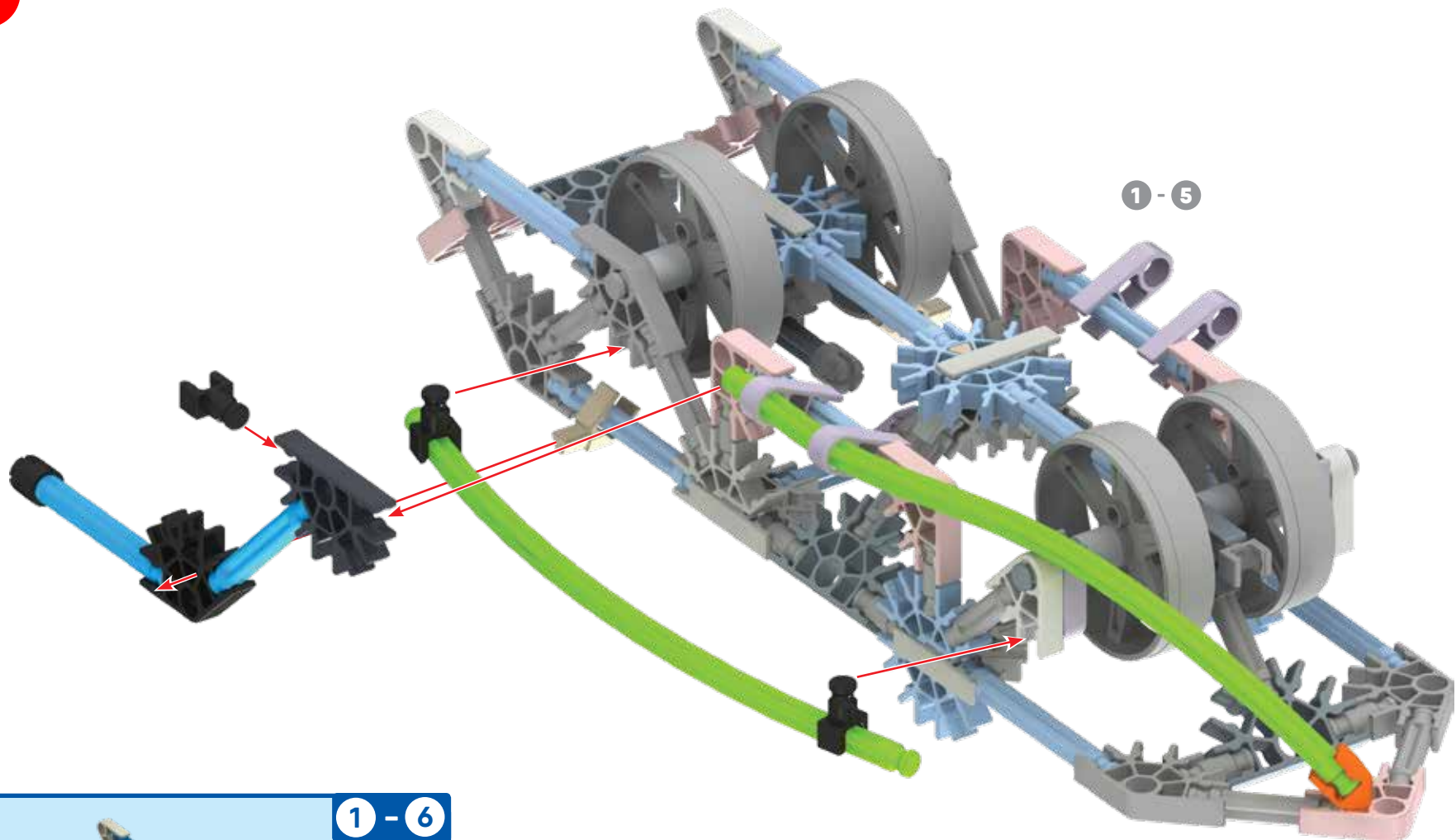

- 2 
- 2  1  3  1 
- 1  1 

7

Rotate model

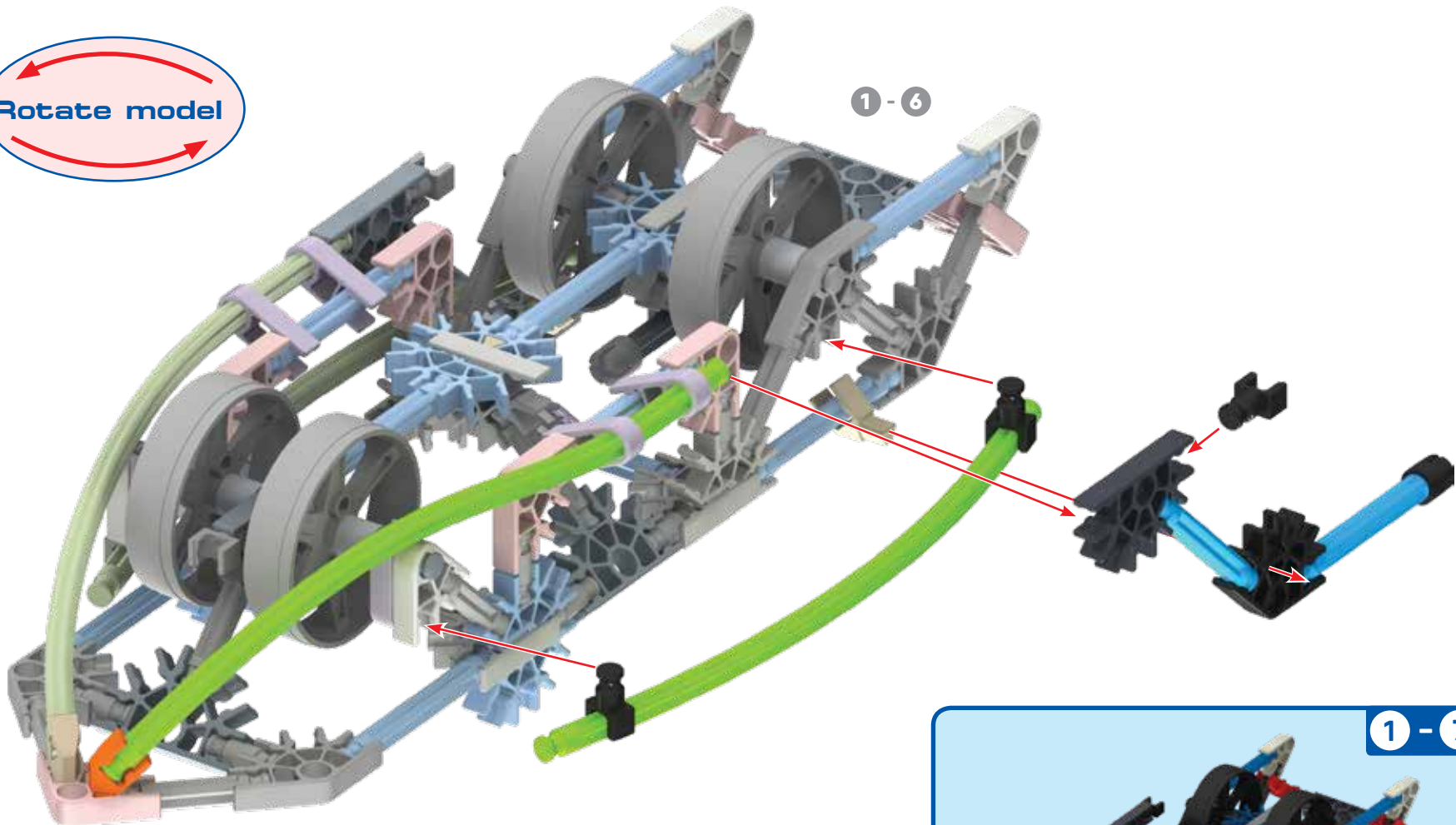

- 2
- 2 1 3 1
- 1
- 1

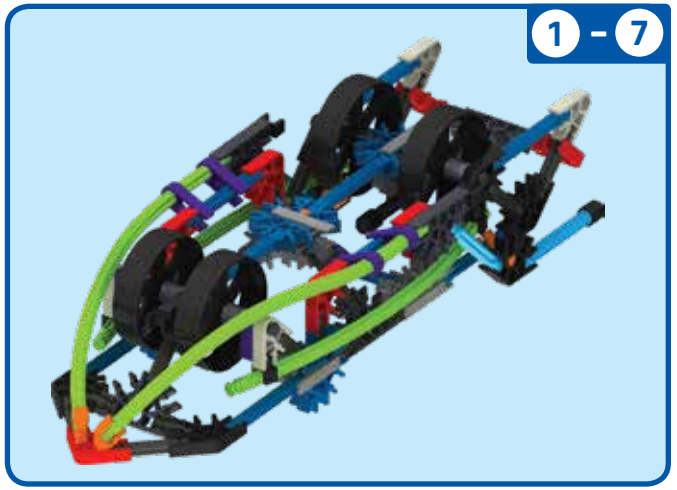



8

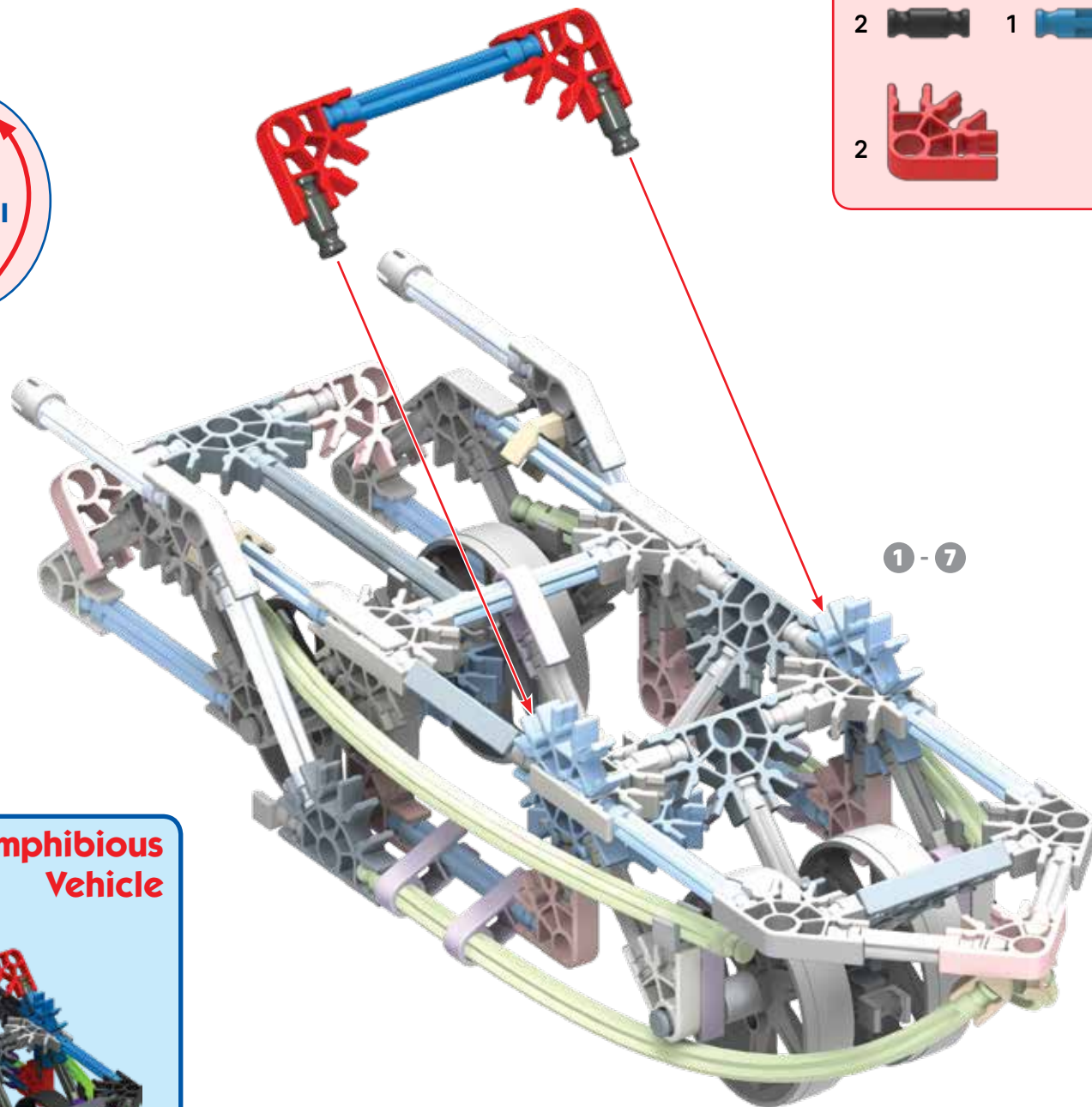
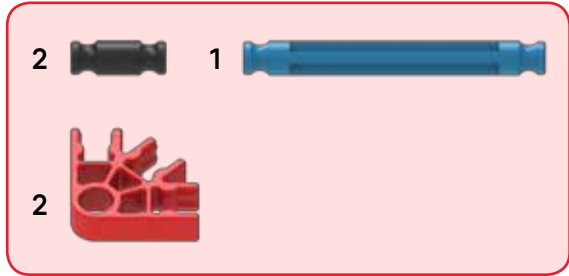
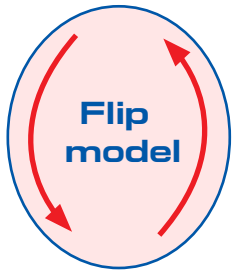

1 - 8

Amphibious  
Vehicle



1

X2

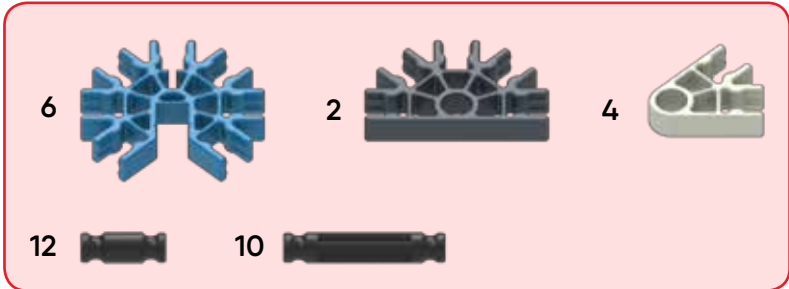
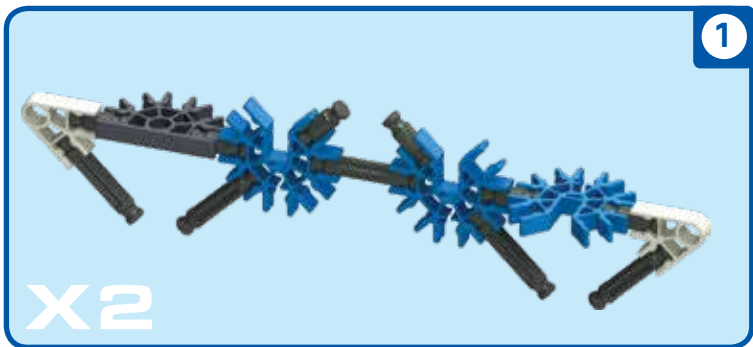
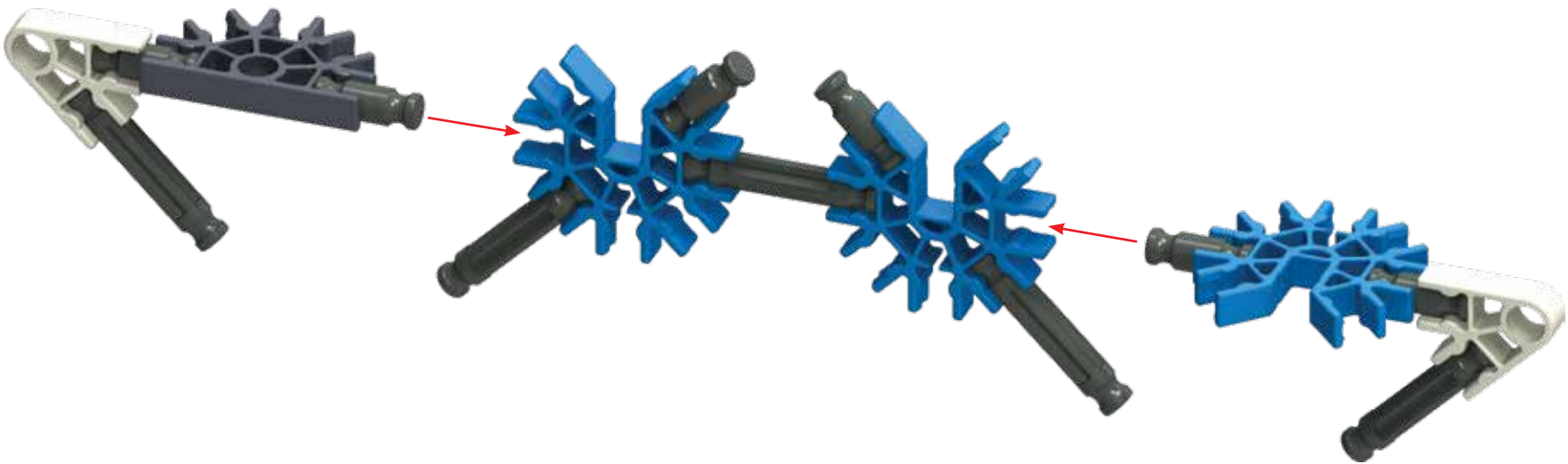

2

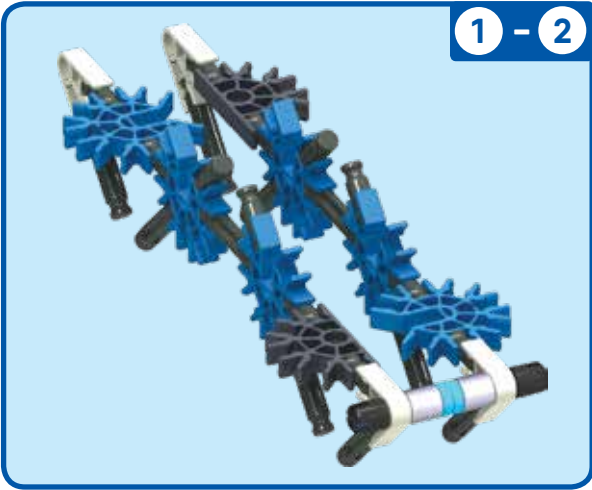
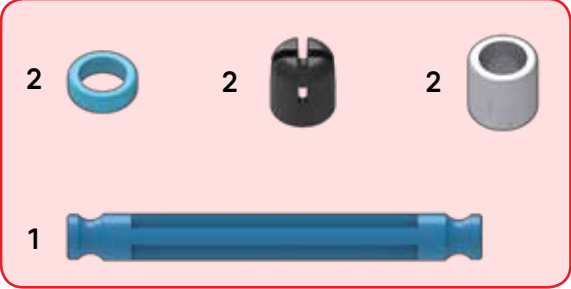
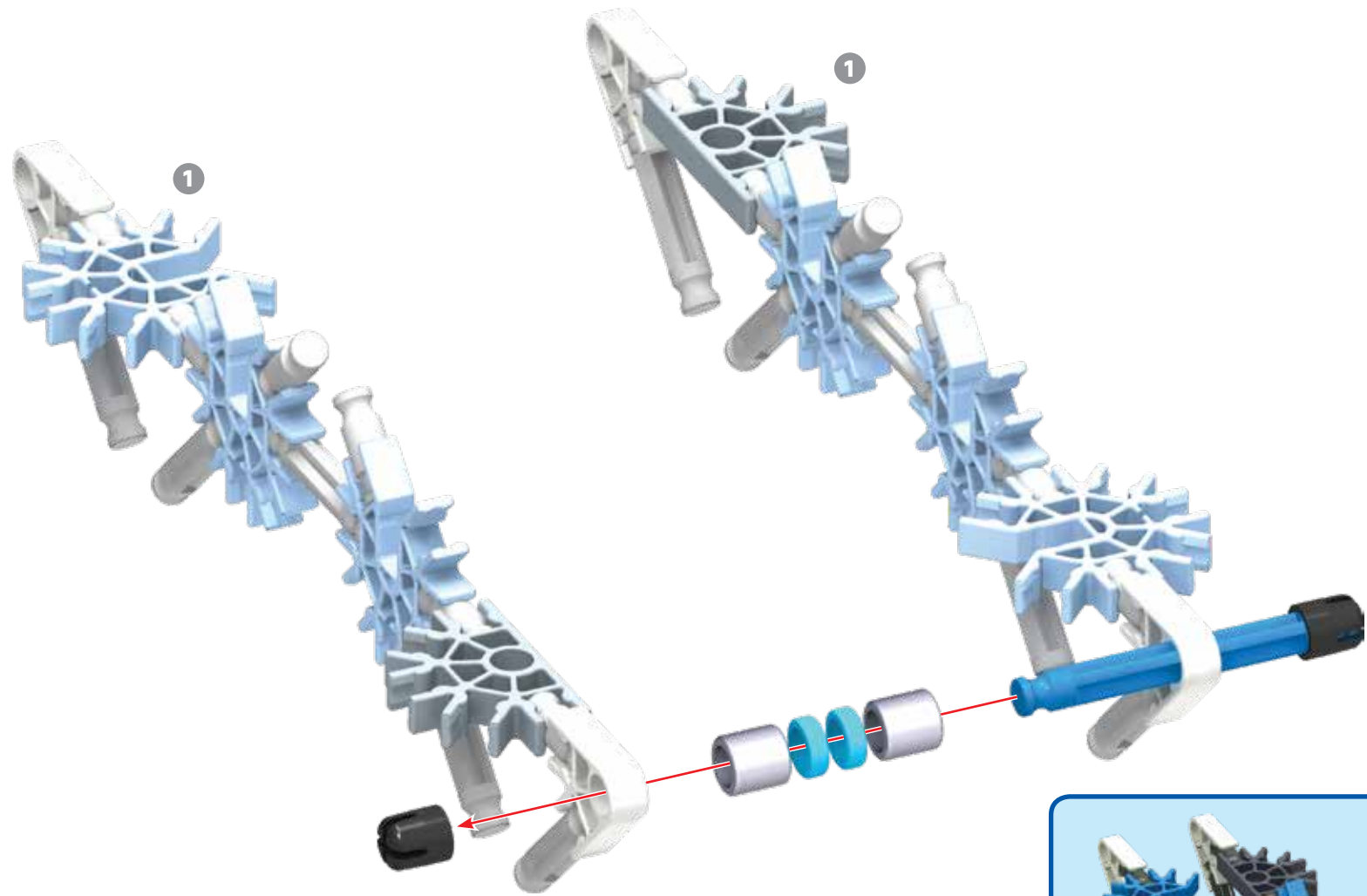

3

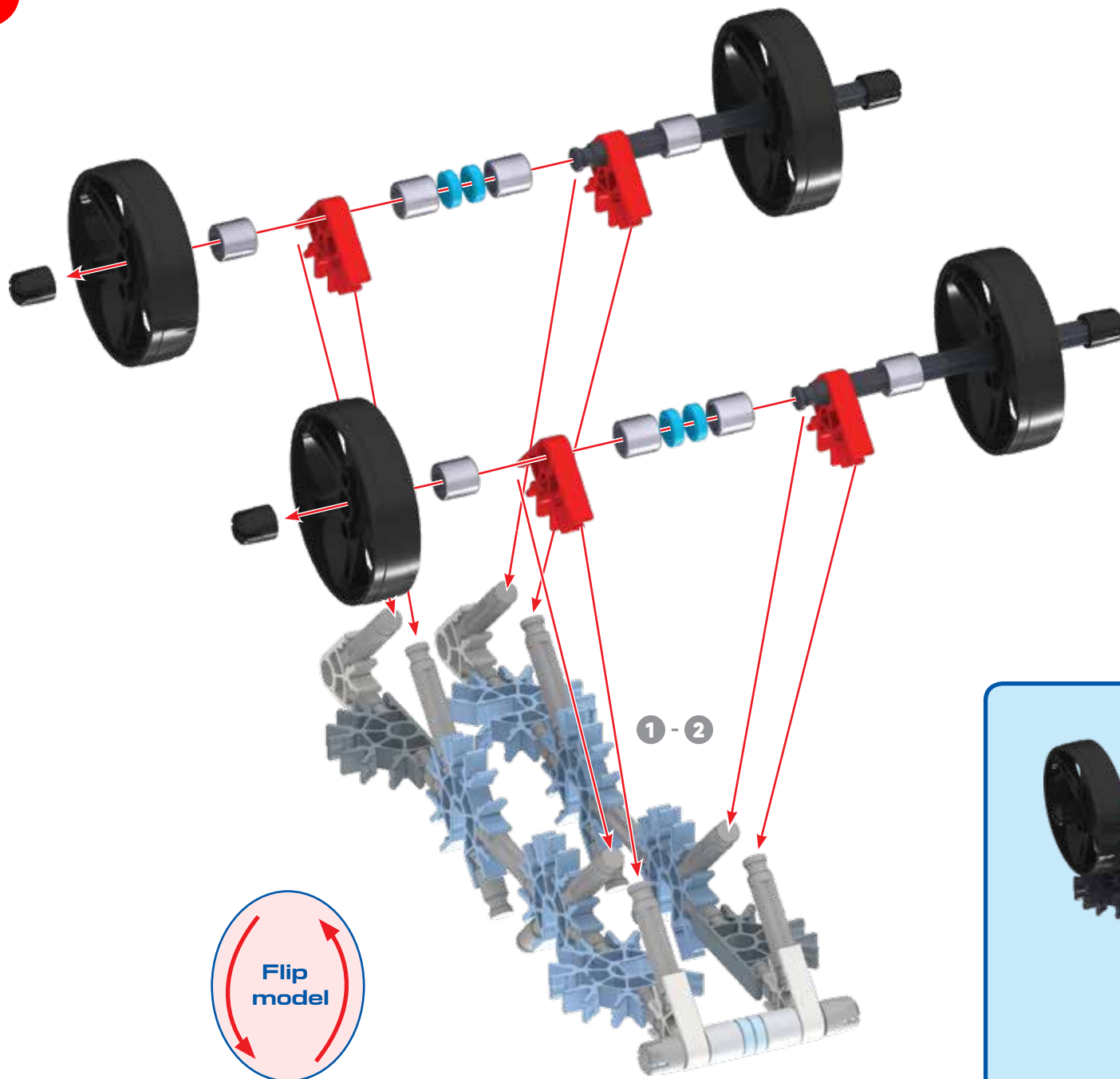

- 4 8 4 4

- 2

- 4

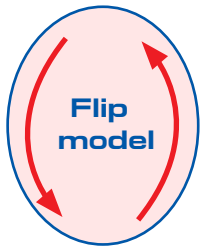

1 - 2

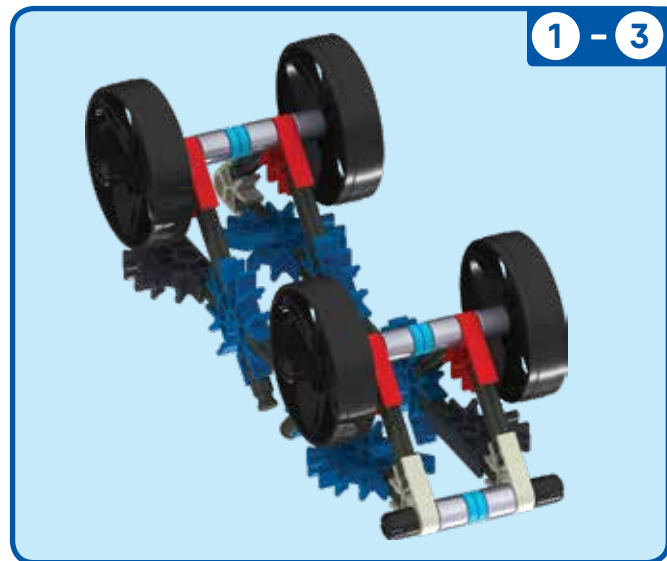





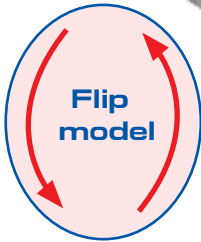
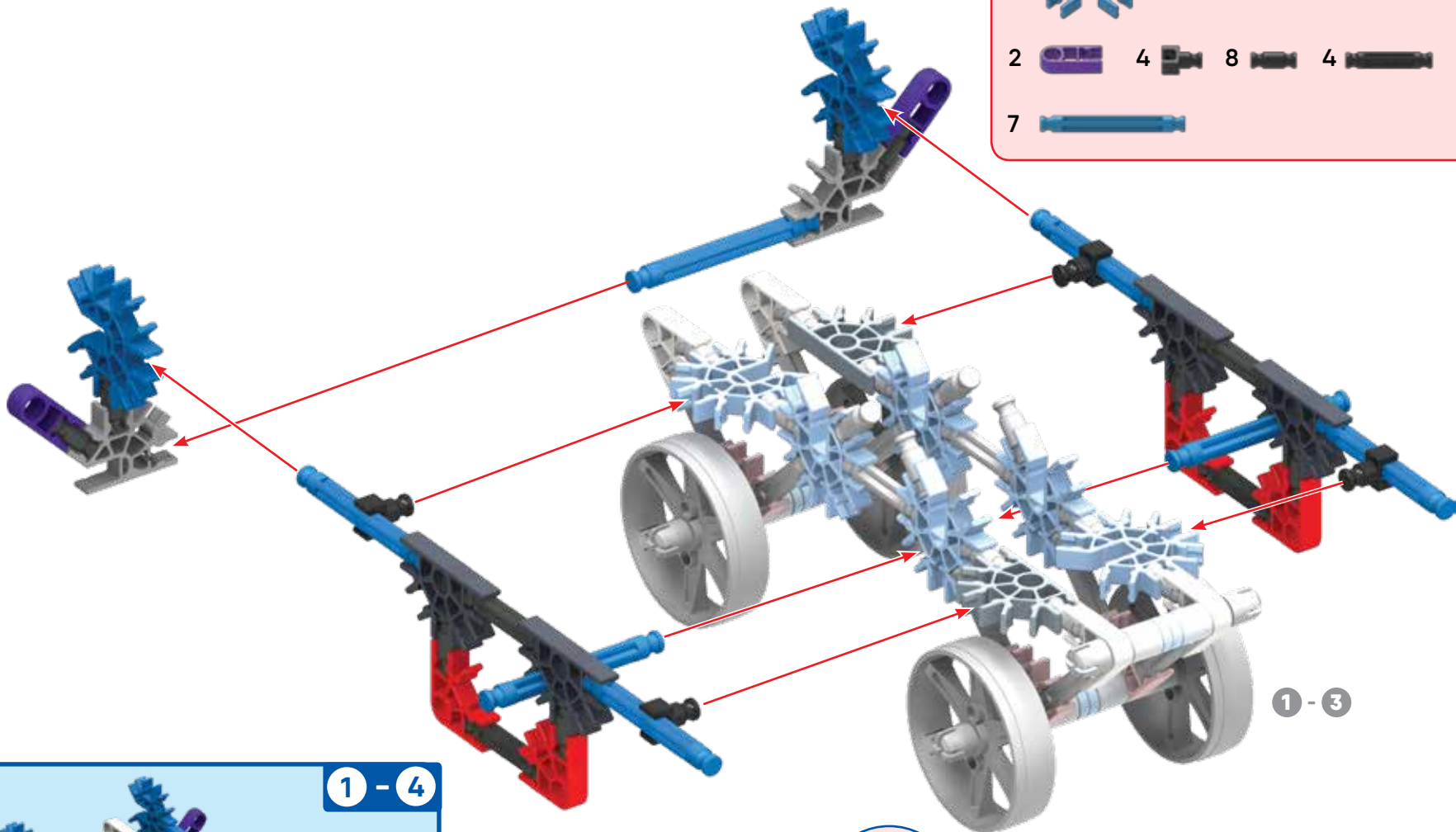





4

- 2
- 4
- 2
- 4
- 2
- 4
- 8
- 4
- 7



5

- 2  2  2  6 
- 4  2  2  2 
- 2  2 
- 2 

1 - 4

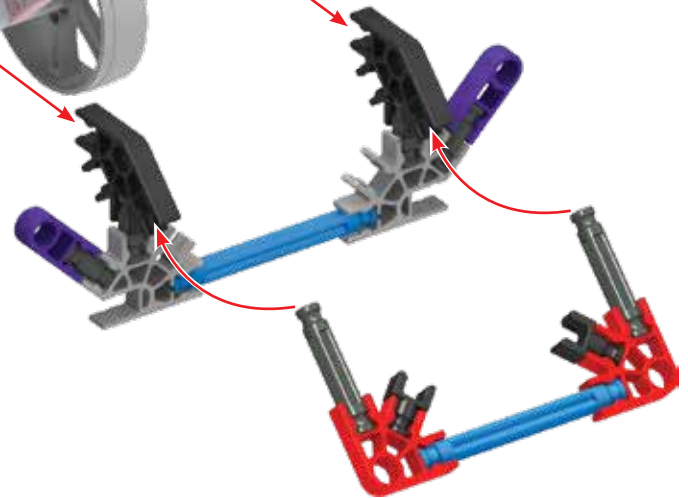
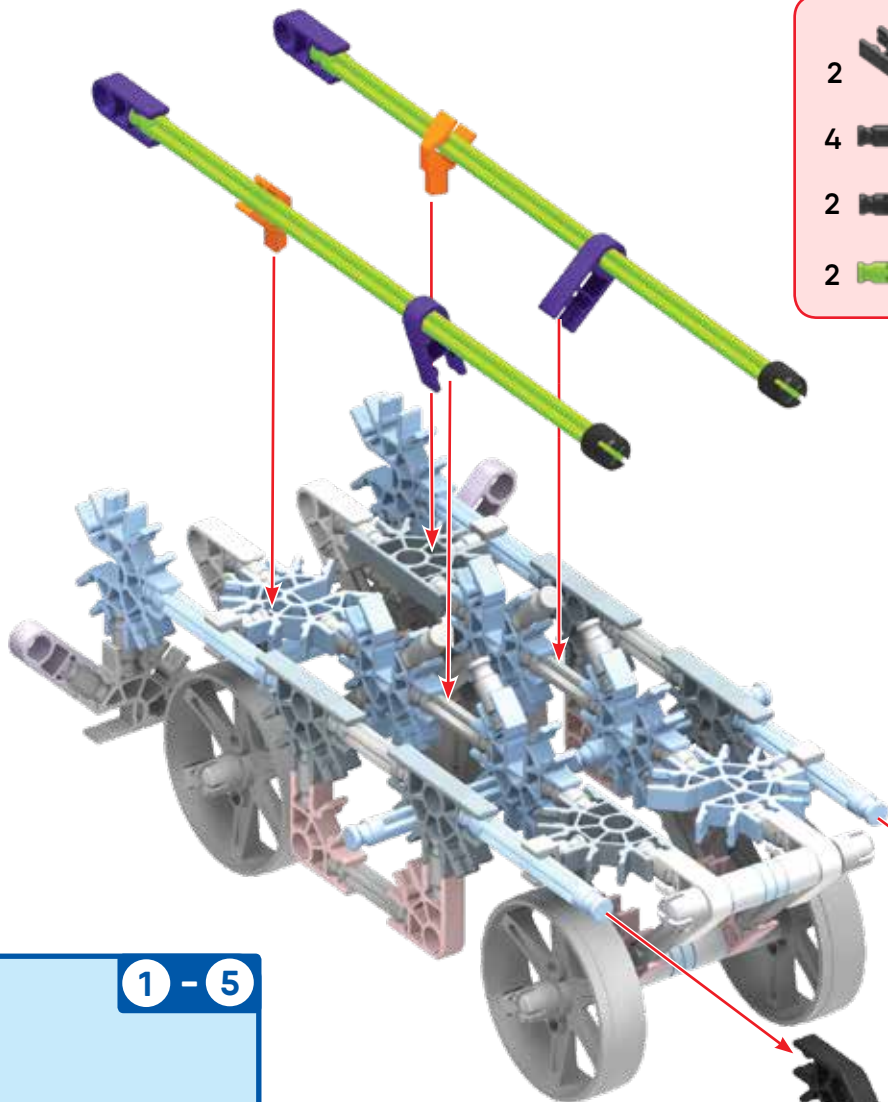

6

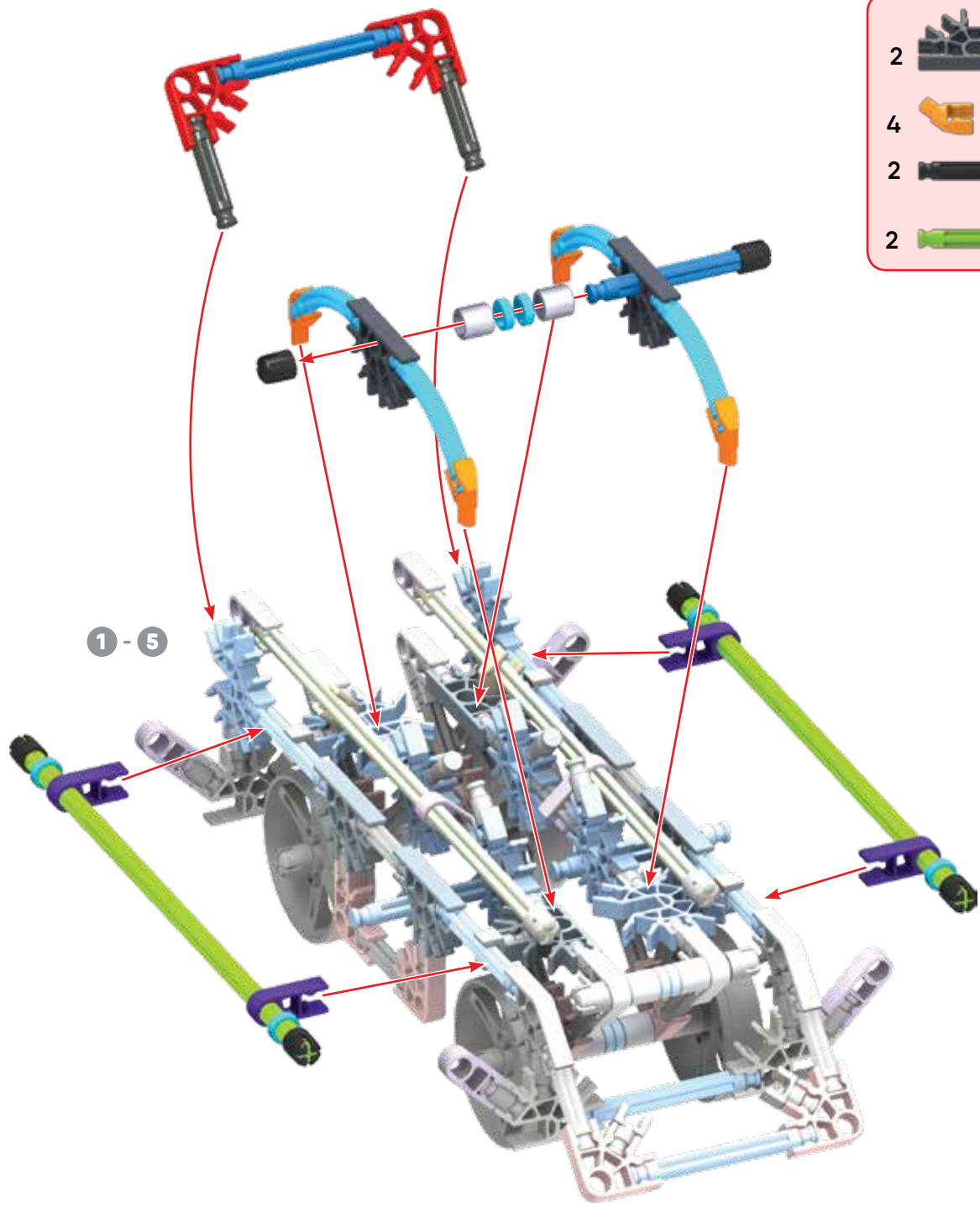







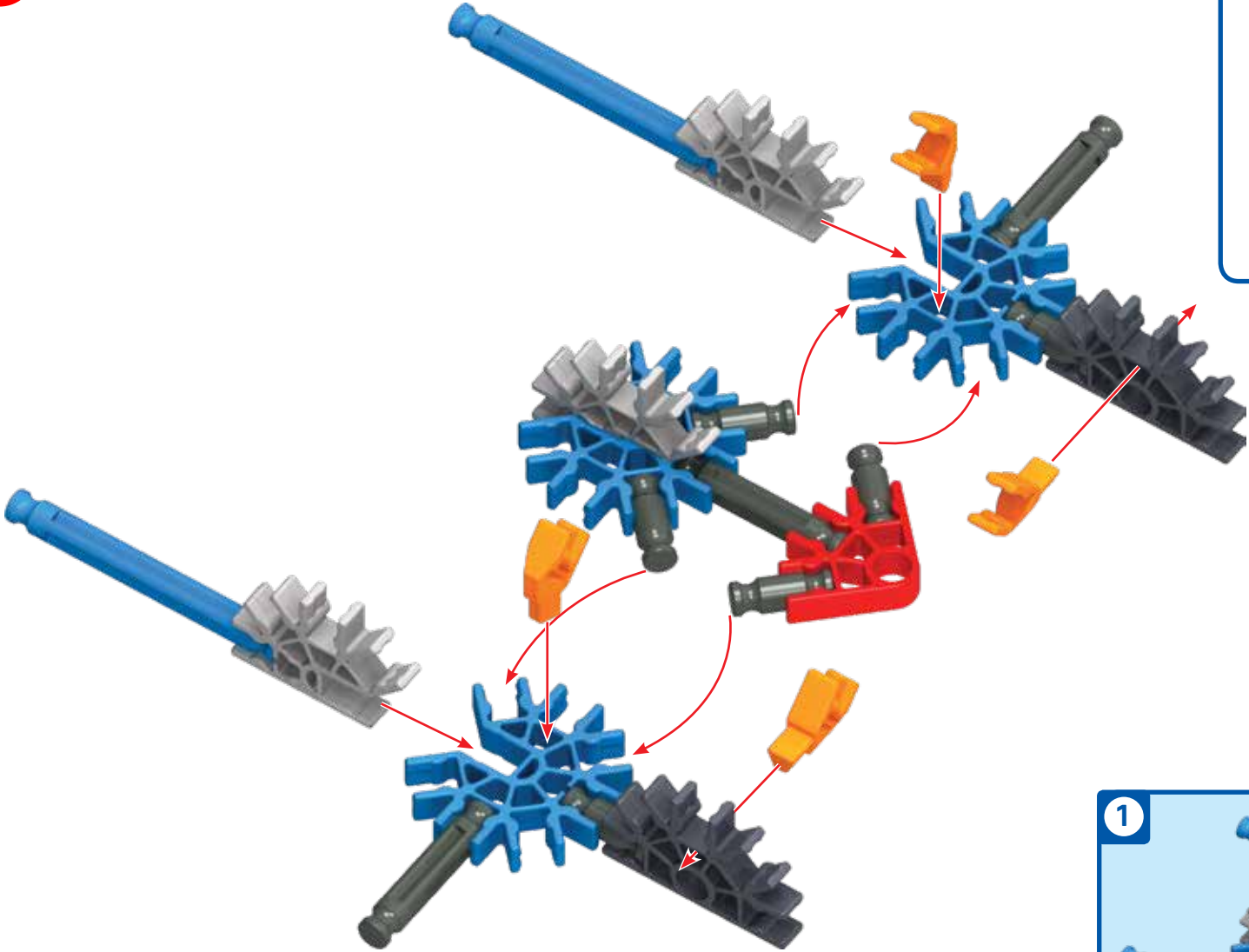

- 2
- 2
- 4
- 4
- 6
- 2
- 6
- 2
- 2
- 4
- 2

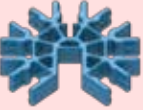

Super Car

1



- 3  2  3  1 
- 6  3  2  4 





2

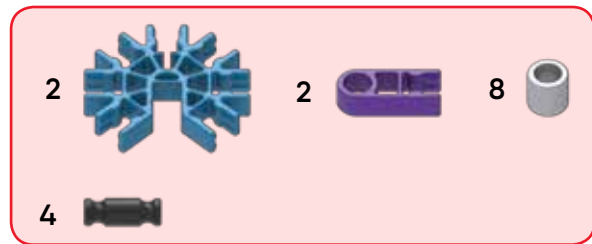
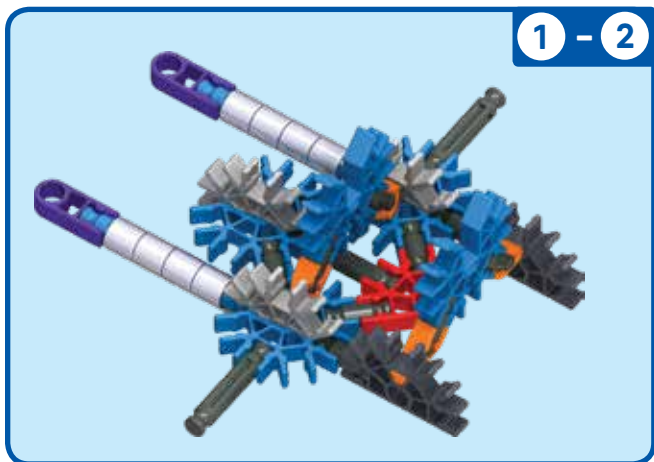
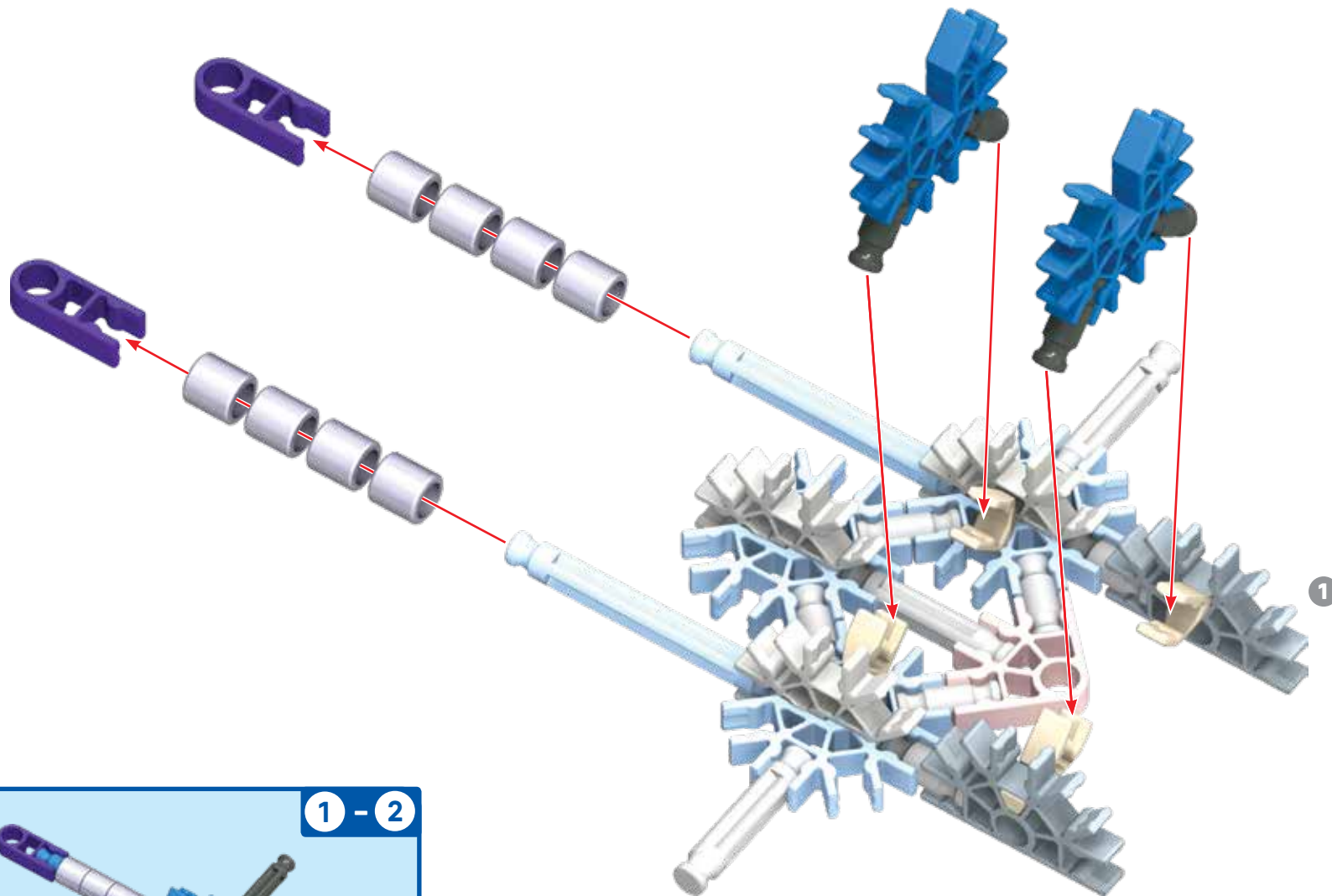





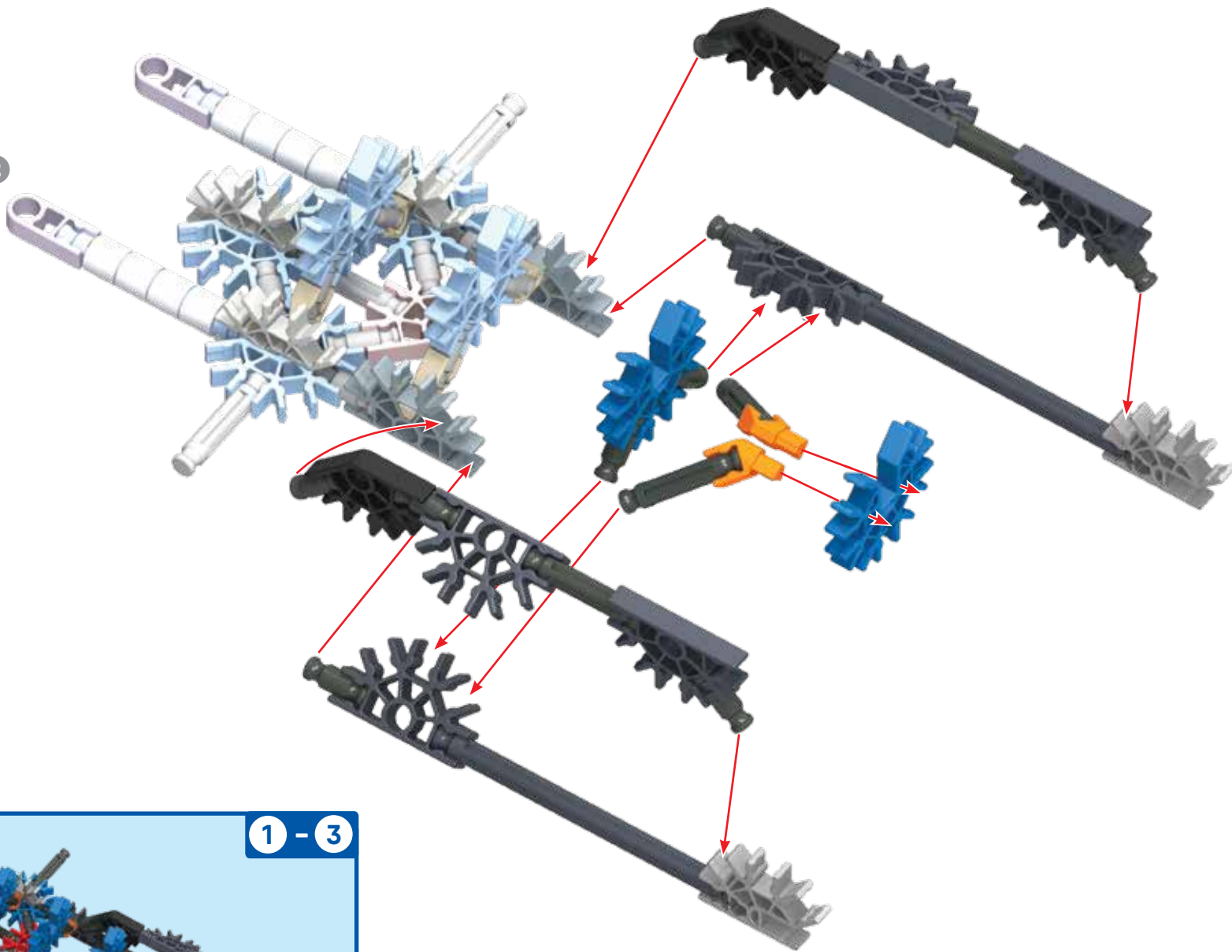



3

1 - 2



1 - 3



- 2 
- 6 
- 2 
- 2 
- 2 
- 10 
- 4 
- 2 

4

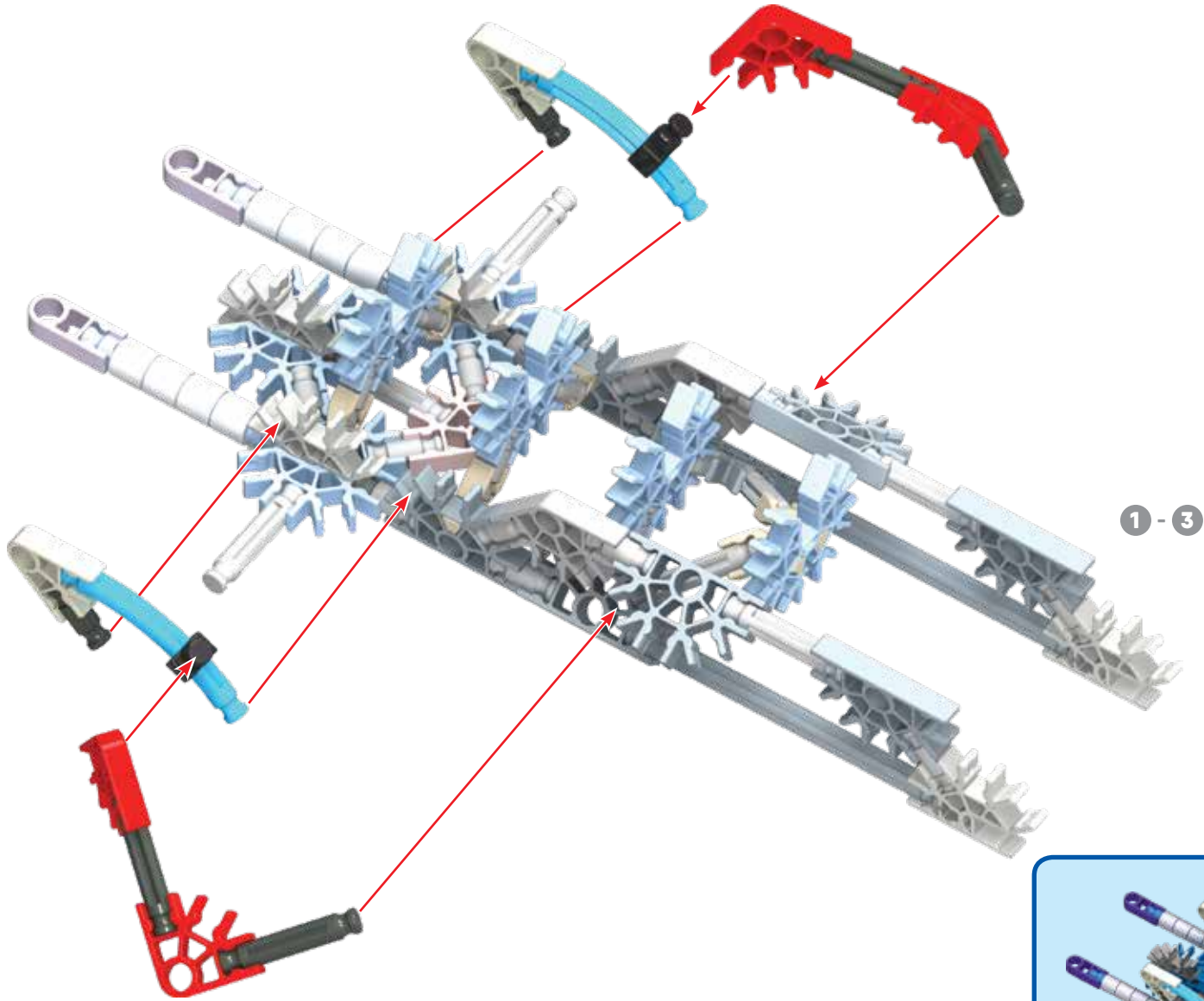







1 - 3

- |   |   |   |  |   |   |
|---|---|---|--|---|---|
| 4 |  | 2 |  | 2 |  |
| 2 |  | 4 |  | 2 |  |



1 - 4

5

- 1 
- 1 
- 2 
- 3 
- 1 
- 1 
- 4 

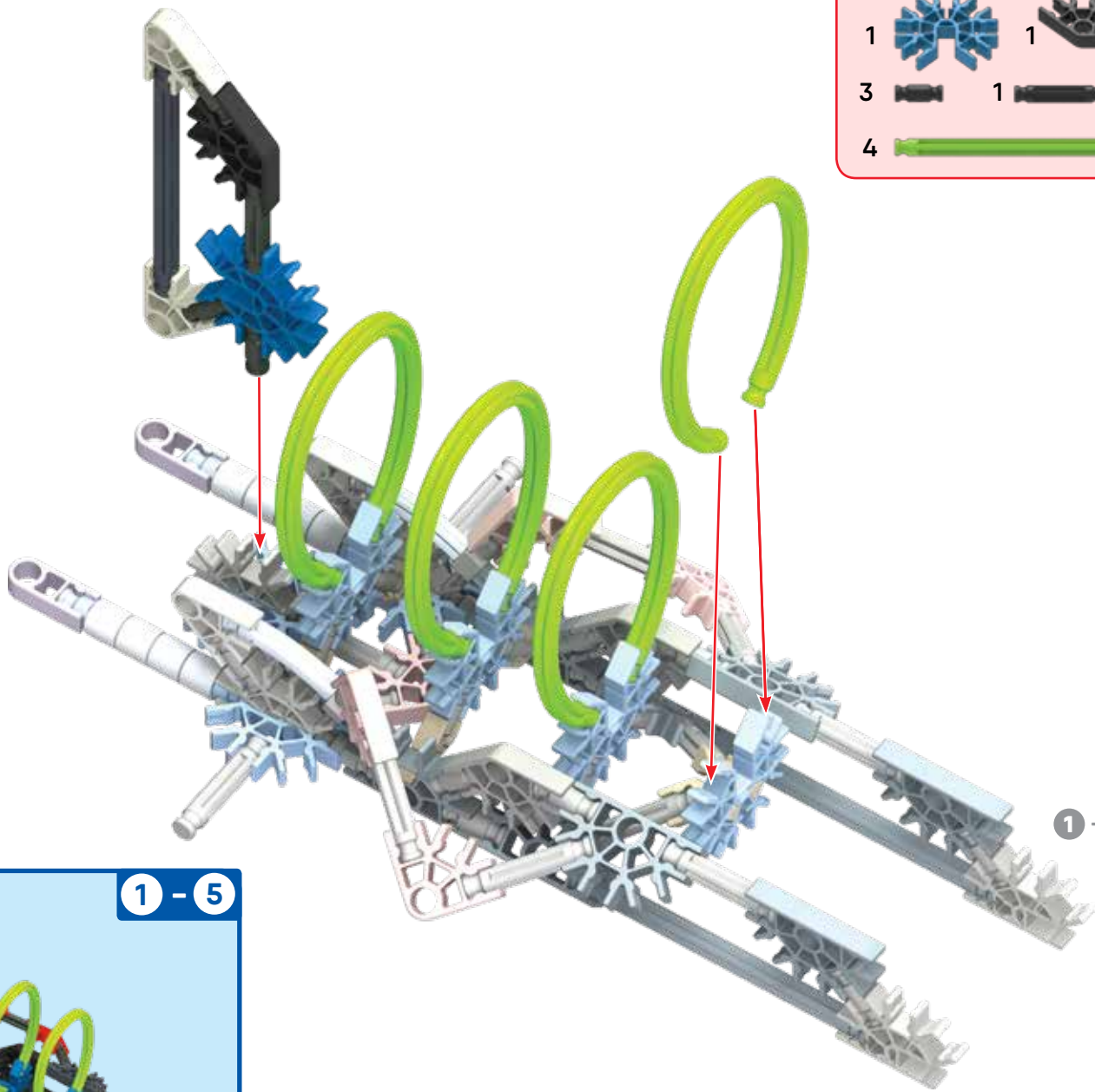

6

- 2
- 2
- 2
- 2
- 2
- 2
- 1
- 2
- 3

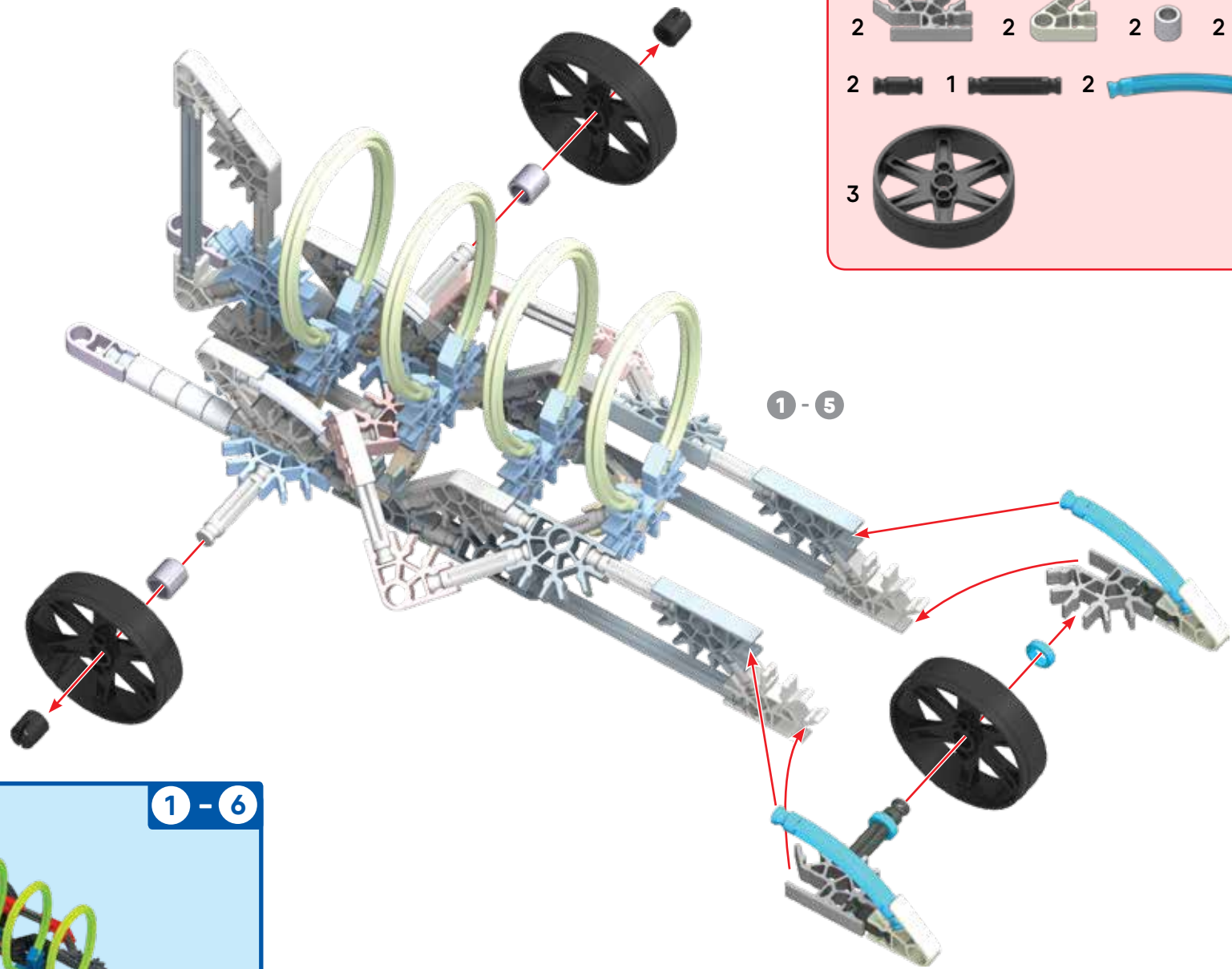



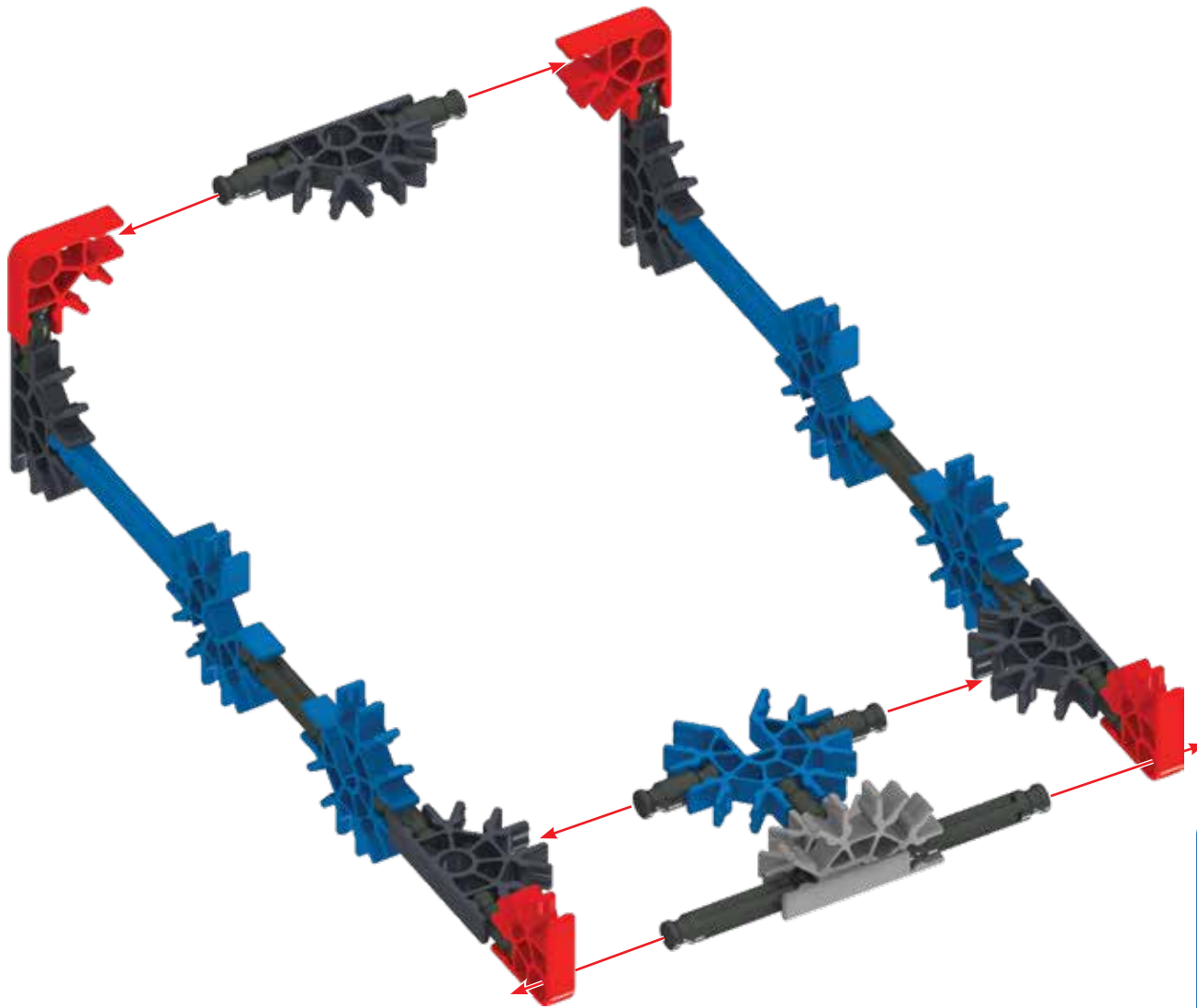

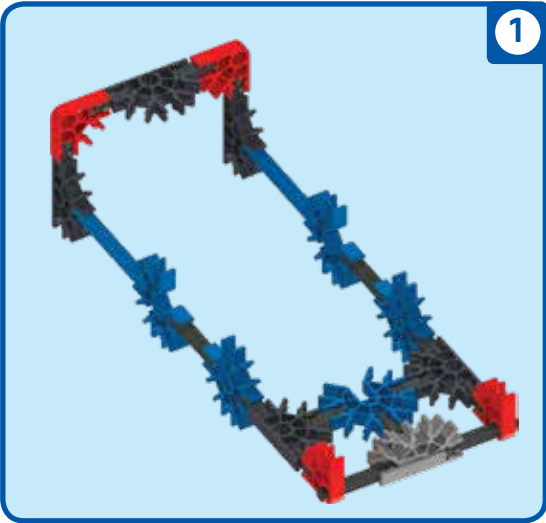

1



SUV



1

- 5 
- 5 
- 2 
- 4 
- 11 
- 4 
- 2 

2

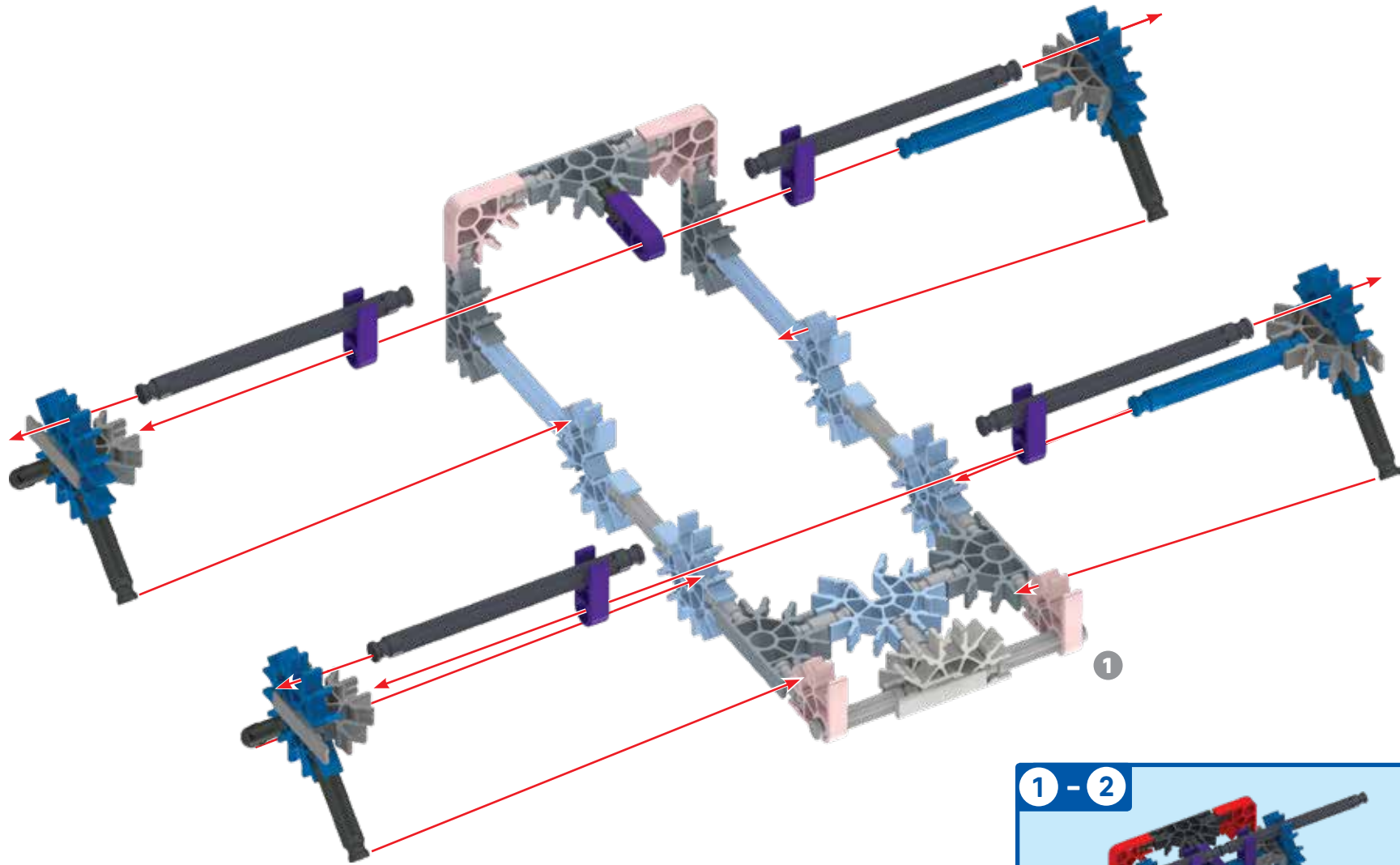

4		4		5		1	
8		2					
4							

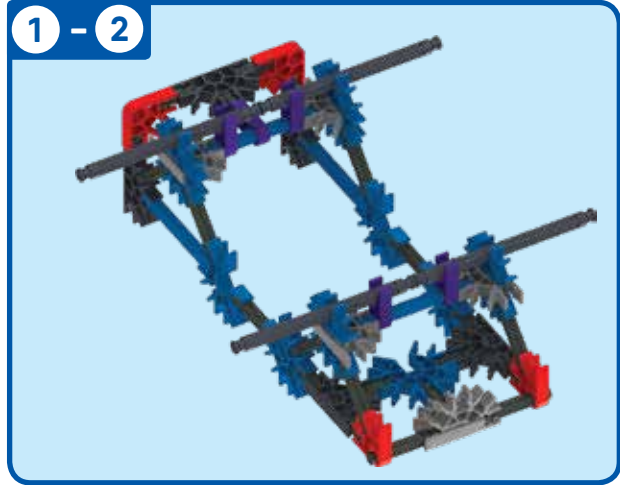

3

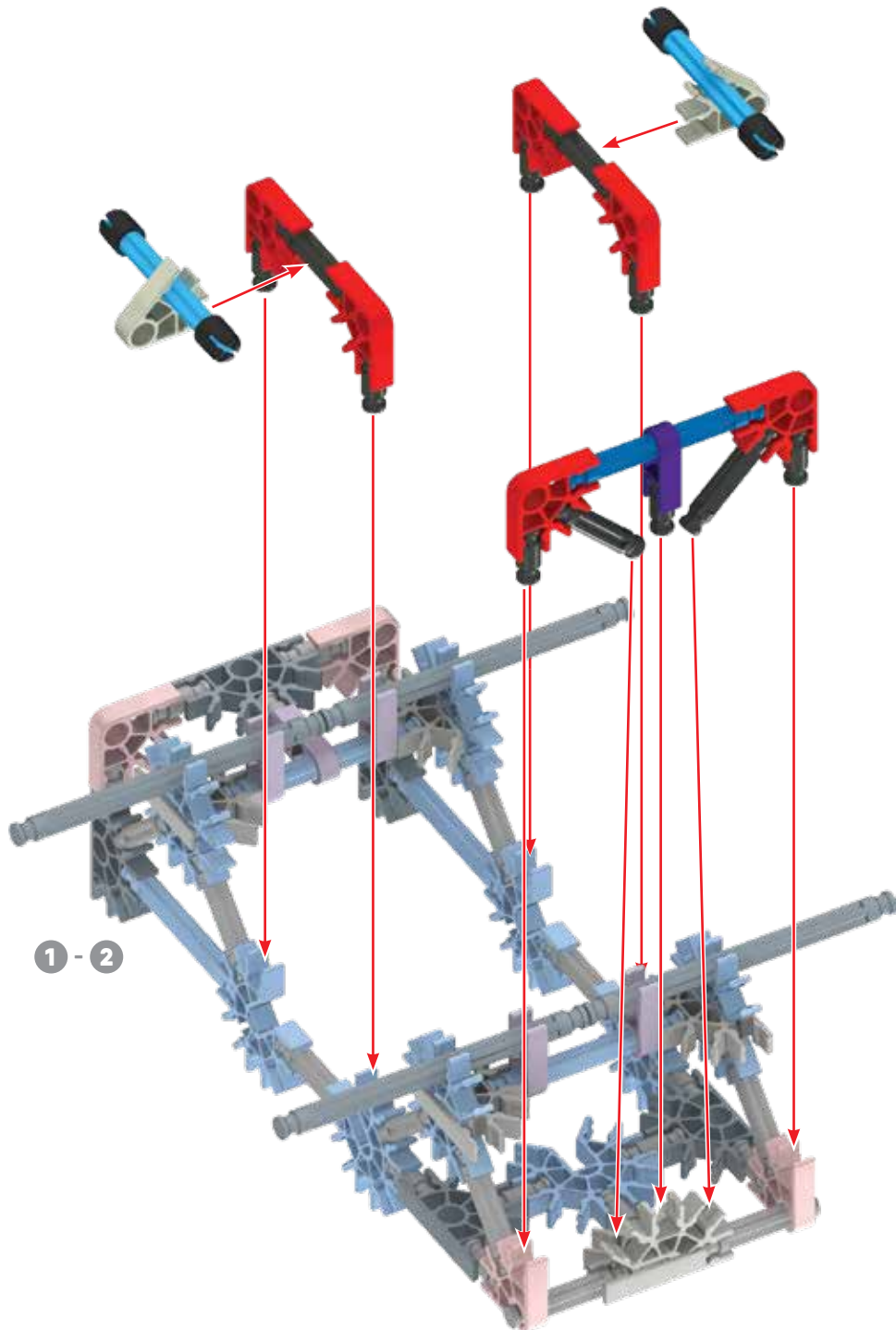

6		2		1		4	
7		4		2			
1							

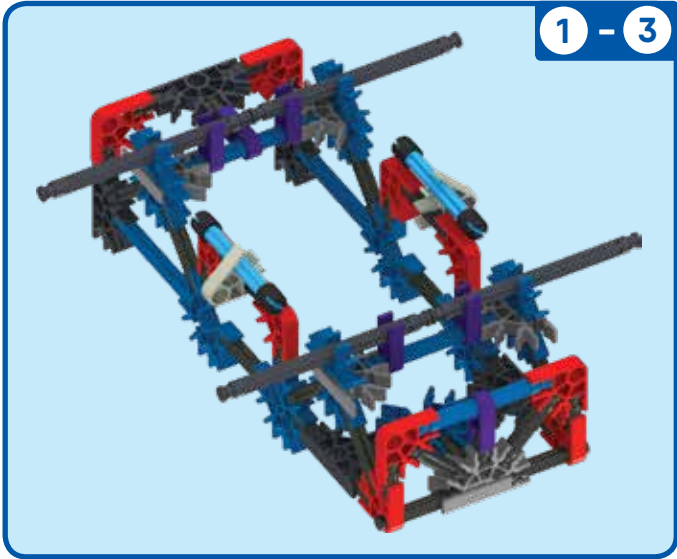



4

- 3
- 2
- 2
- 2
- 2
- 2
- 8
- 2
- 4

Flip model

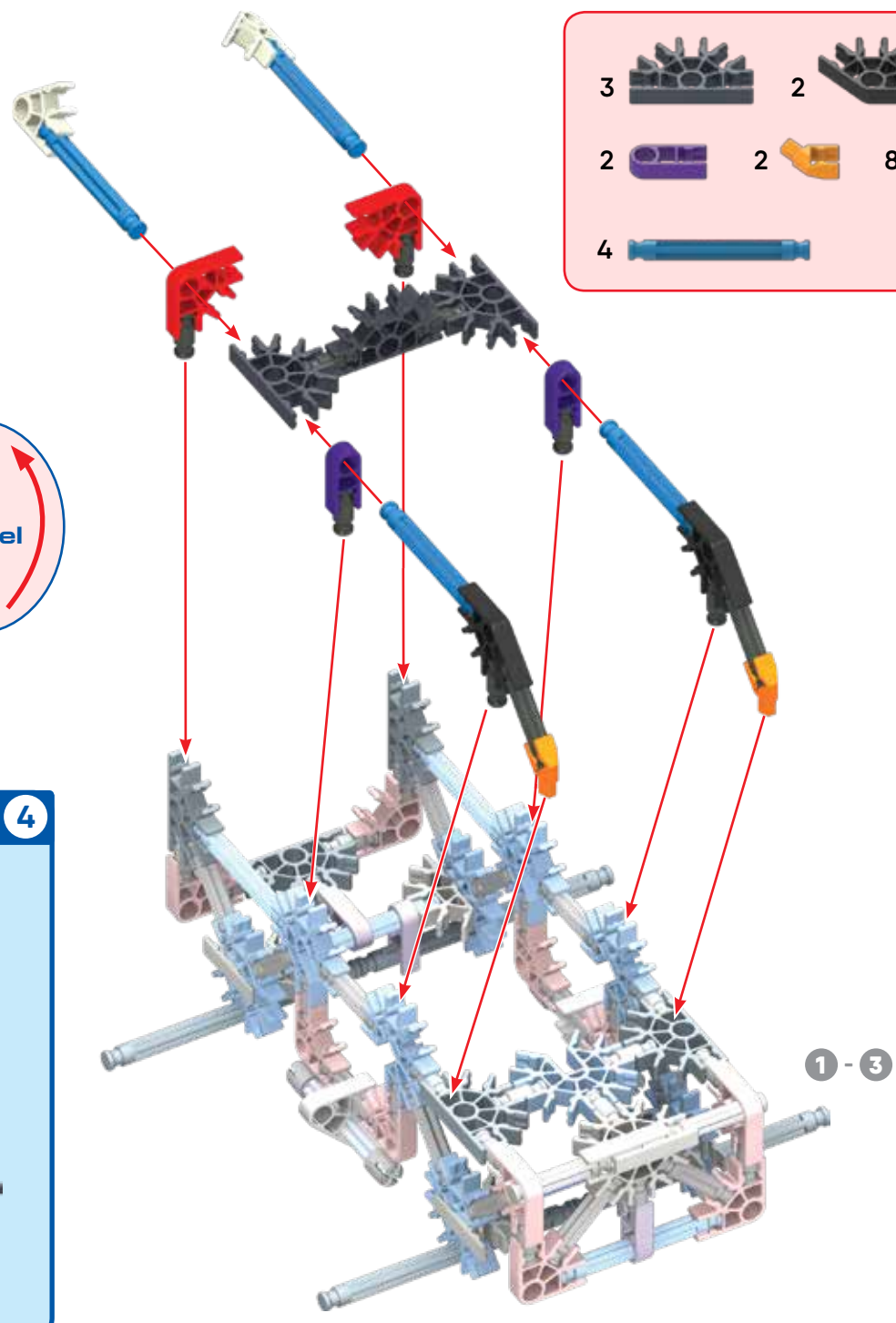
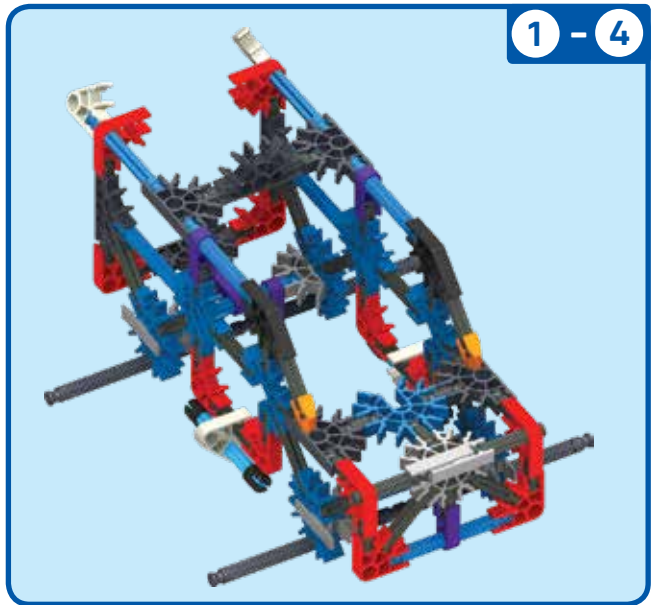

5

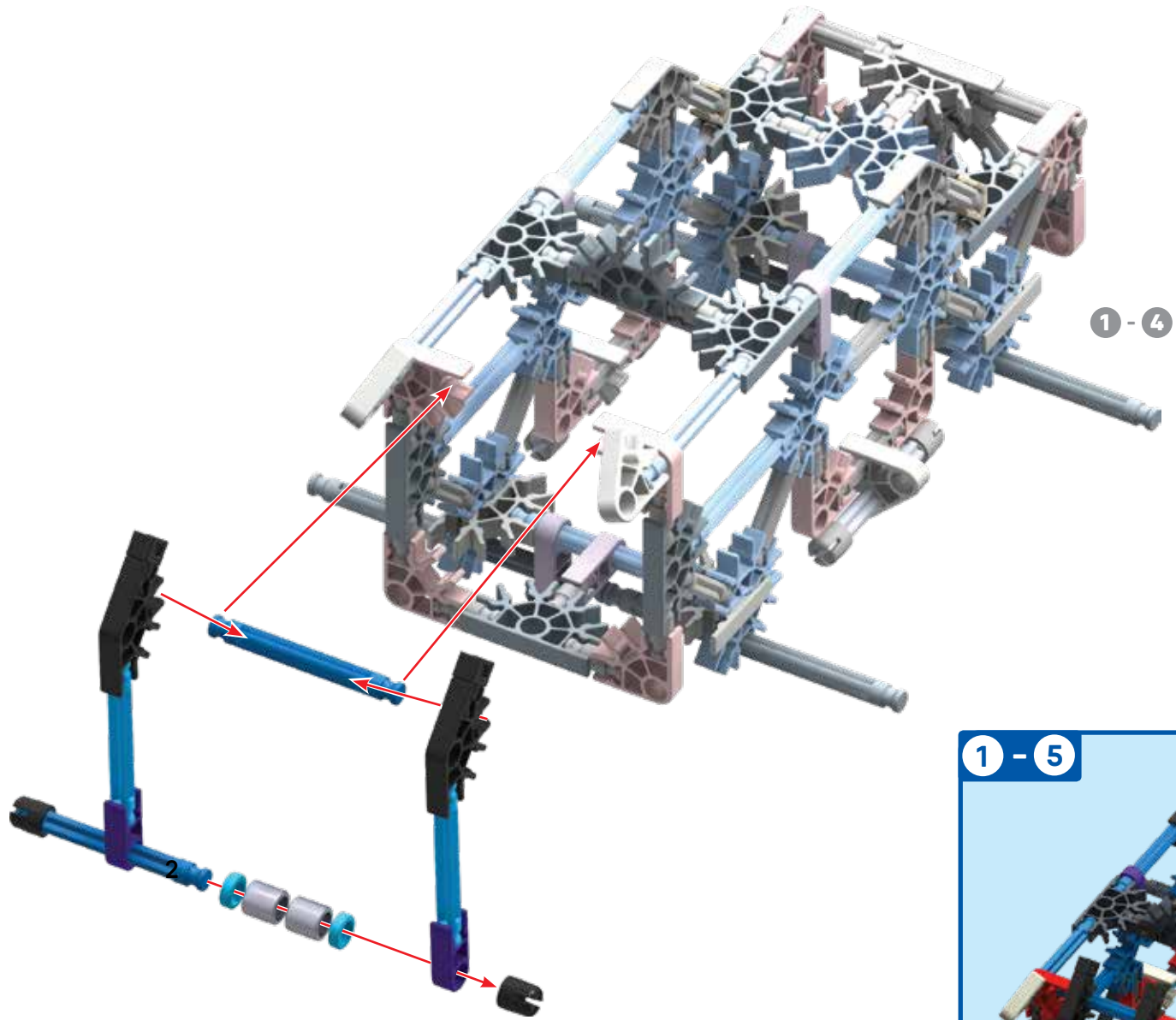

1 - 4

1 - 5

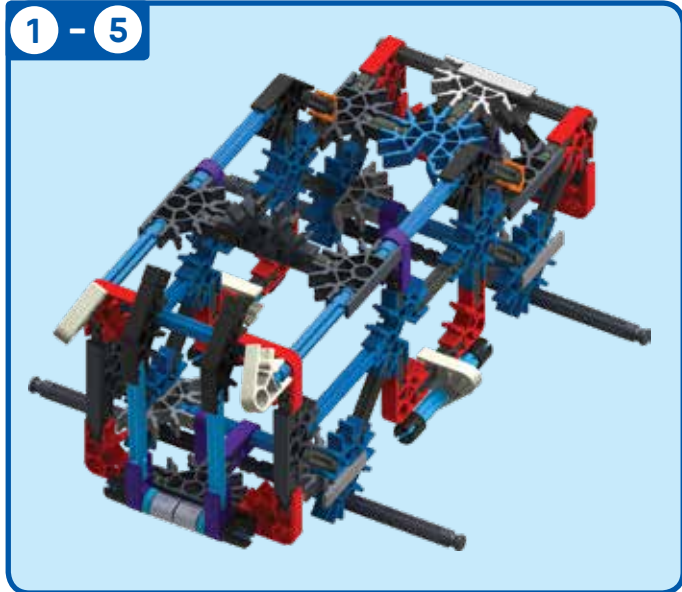

- 2
- 2
- 1
- 2
- 2
- 2
- 2
- 2

6

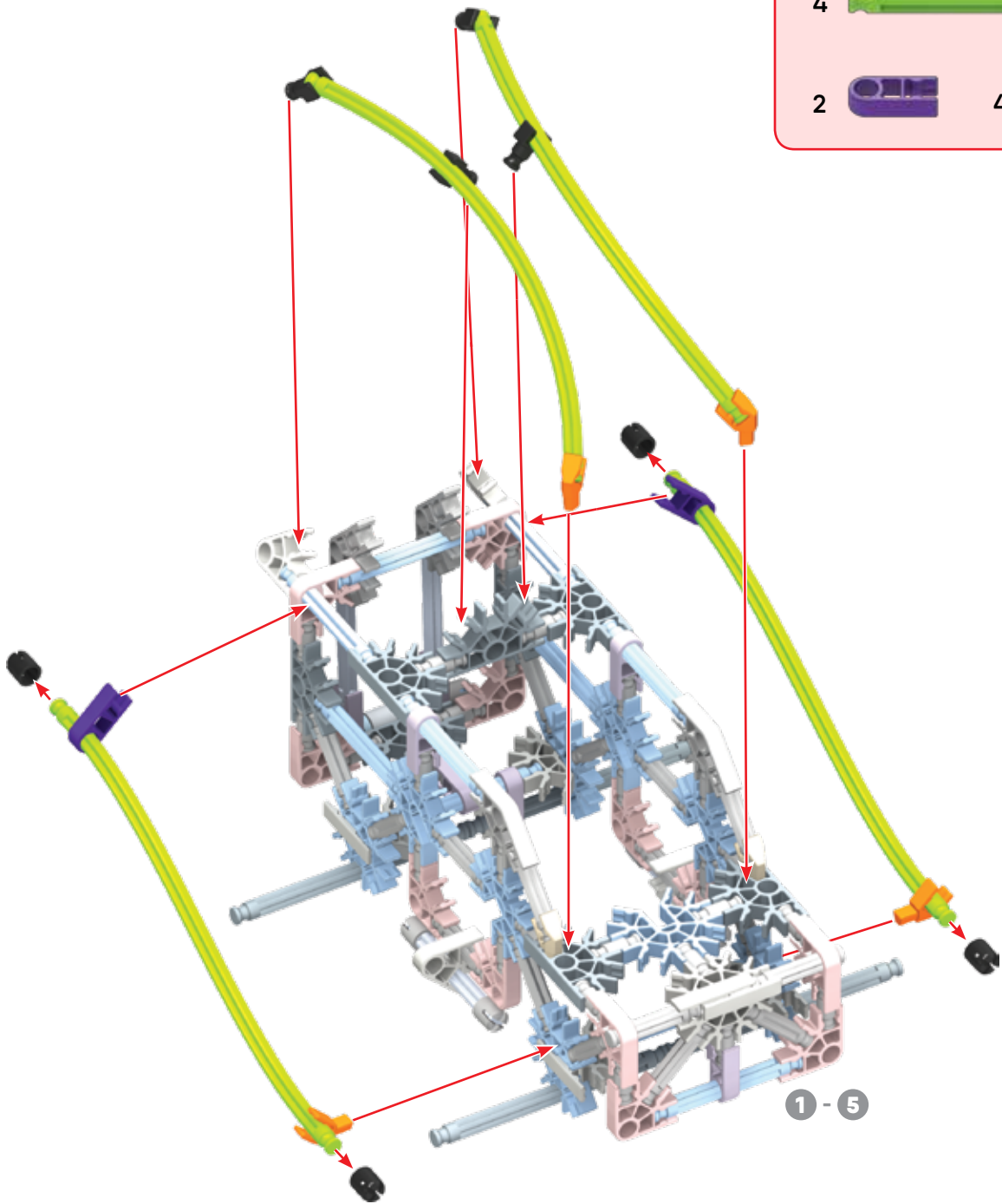

- 4
- 2
- 4
- 4
- 4

1 - 5





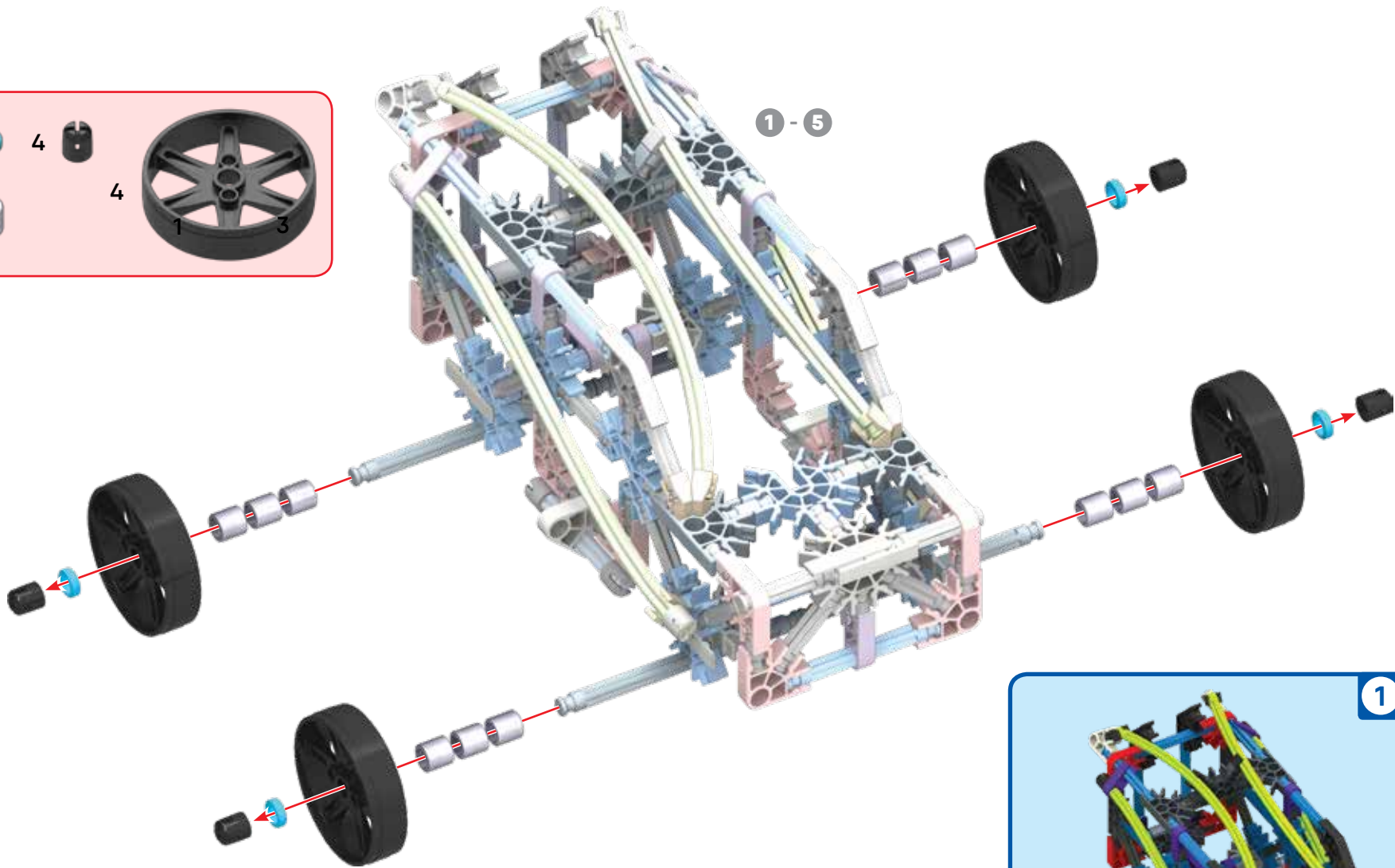
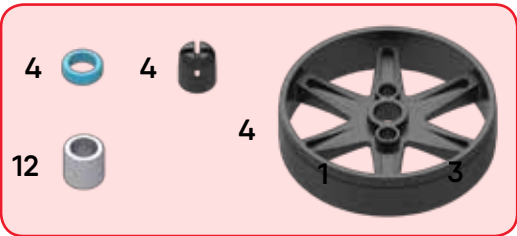



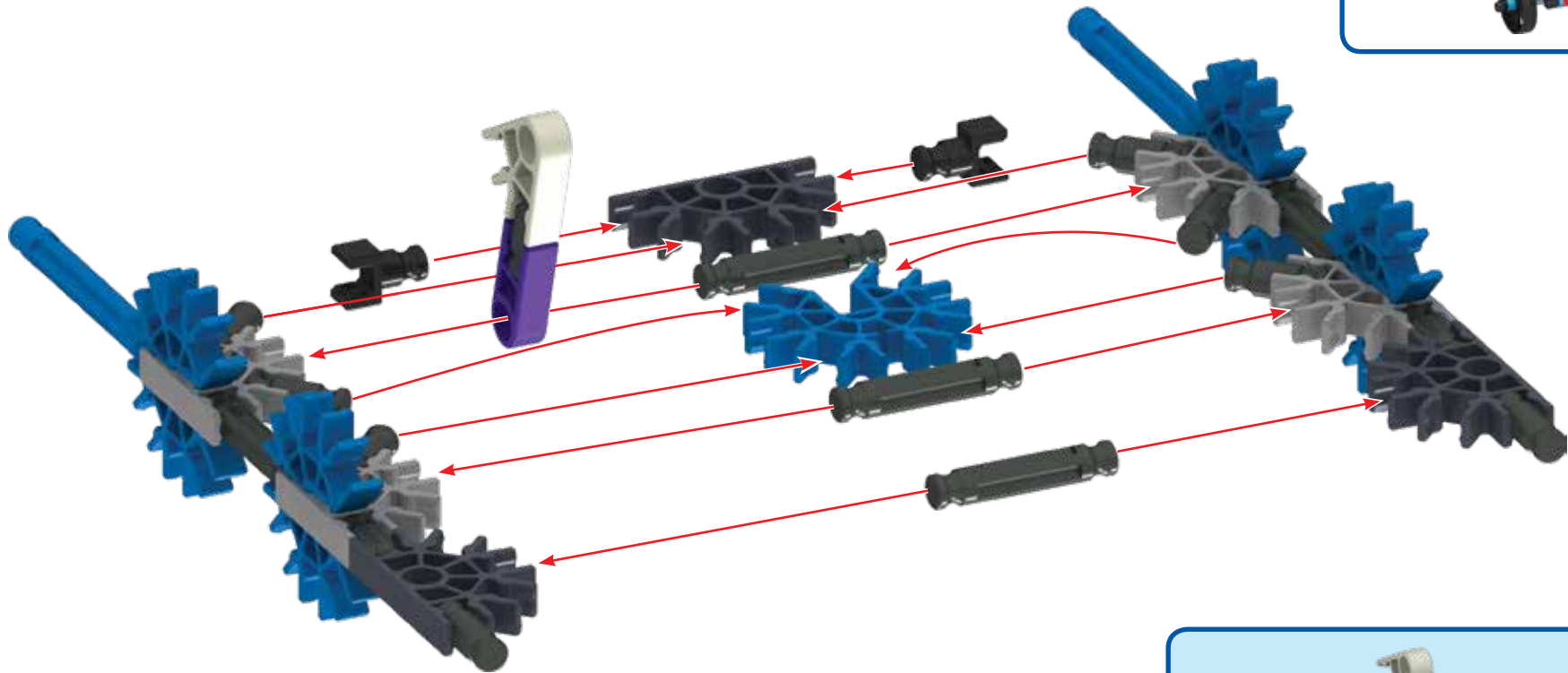

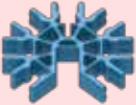
7

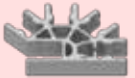

1



- 5  3  4  1 
- 1  2  11  5 
- 2 

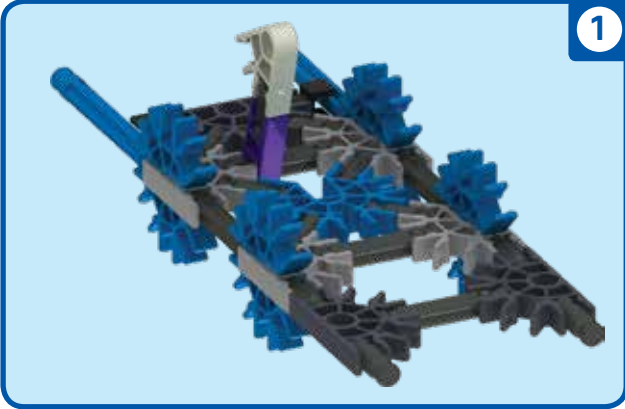

2

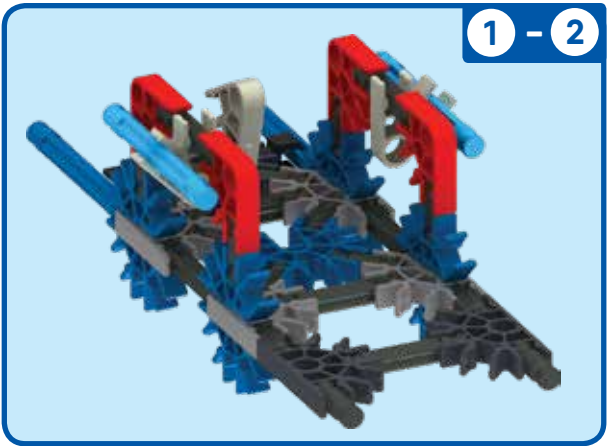
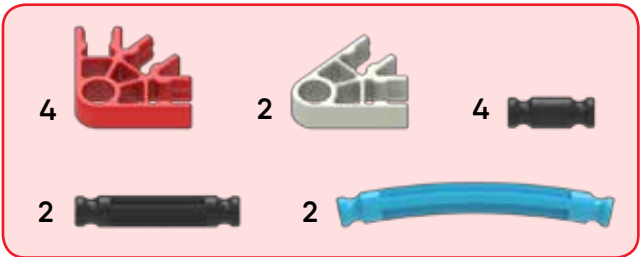
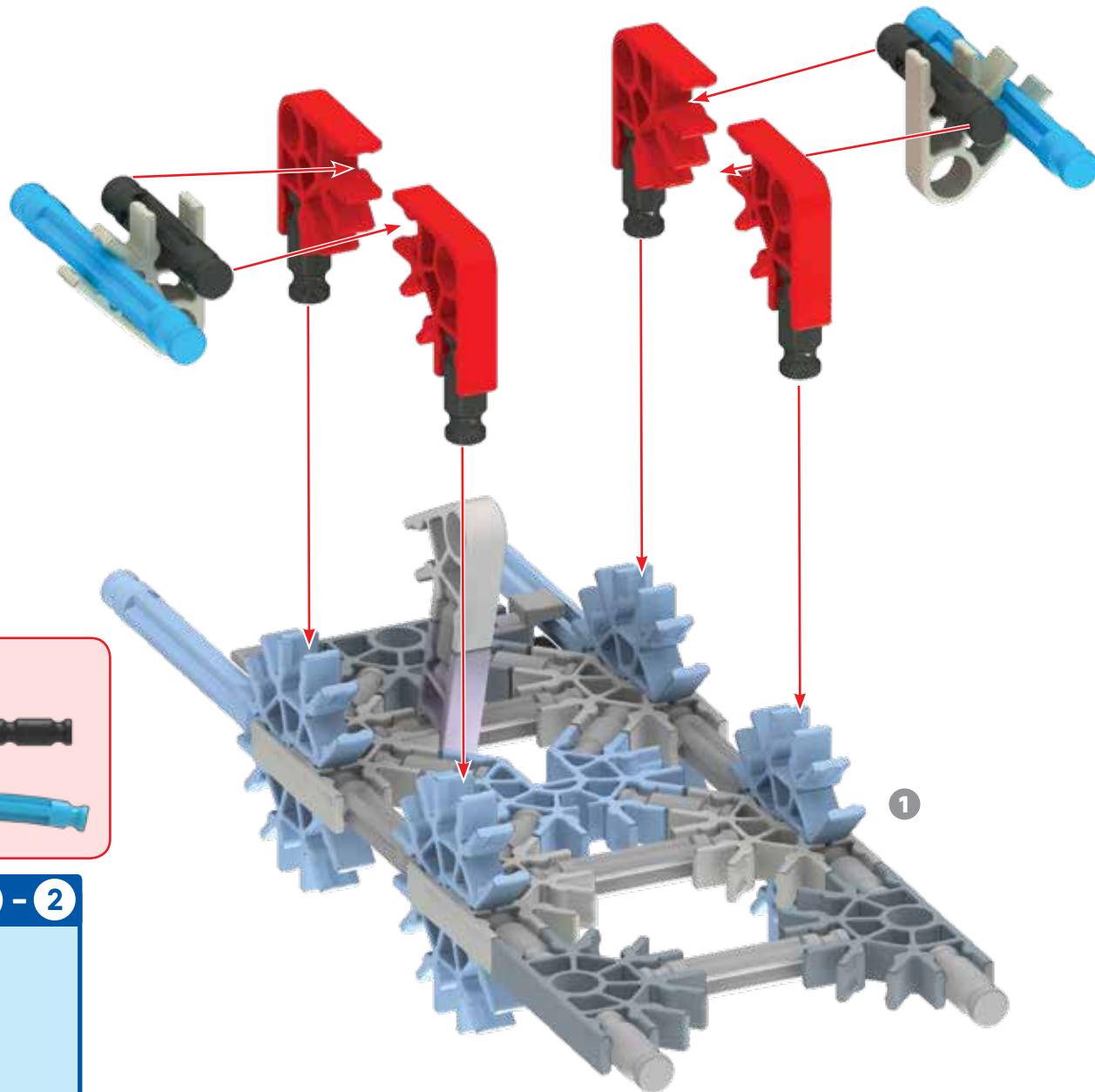

3

- 4
- 4
- 1
- 2
- 7
- 4
- 2

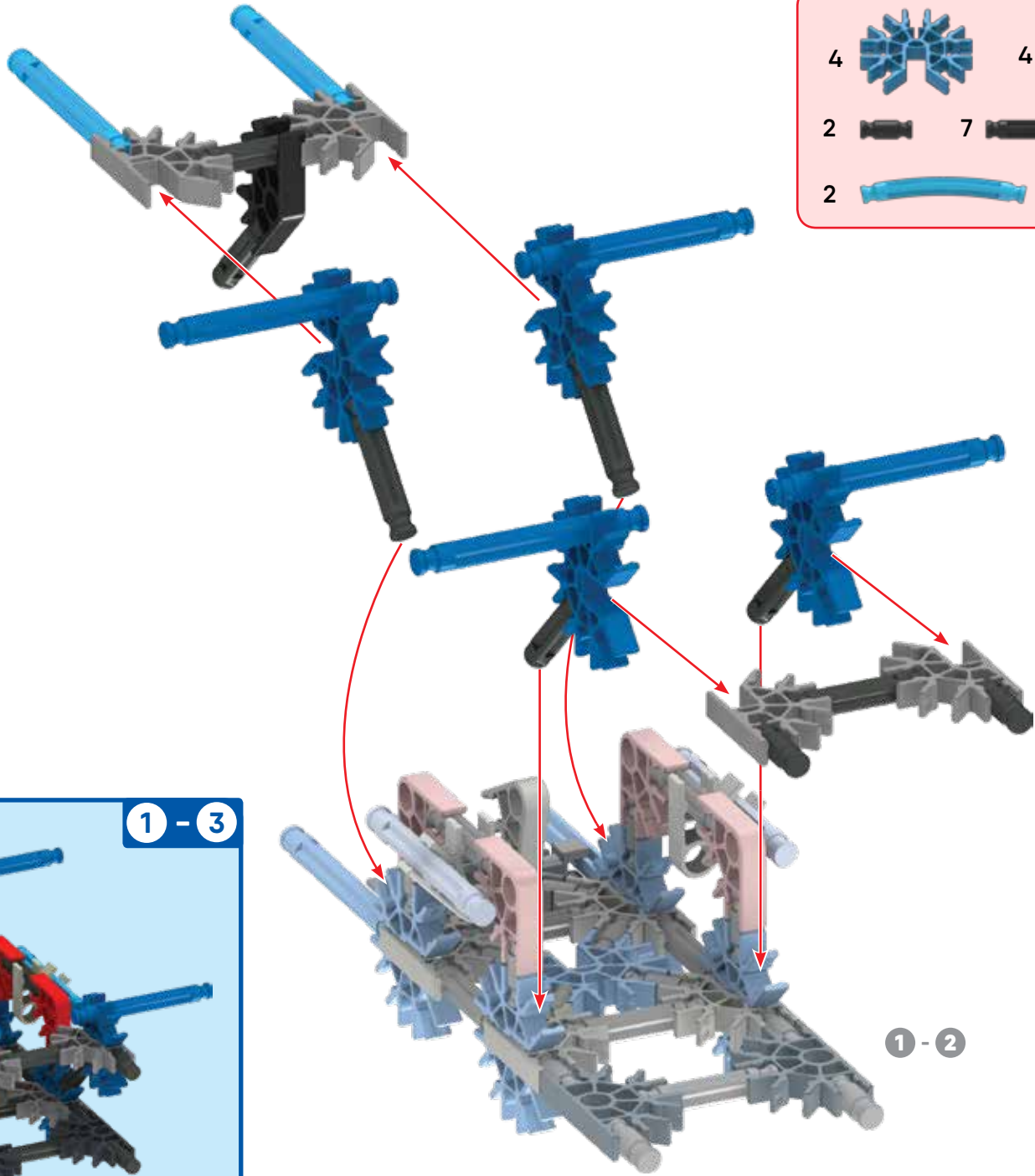

1 - 2

4

Flip model

1 - 3

Rotate model

1 - 4

- |   |  |   |  |   |  |   |  |   |  |
|---|--|---|--|---|--|---|--|---|--|
| 3 |  | 2 |  | 2 |  | 4 |  | 2 |  |
| 2 |  | 1 |  | 1 |  |   |  |   |  |
| 1 |  |   |  |   |  |   |  |   |  |

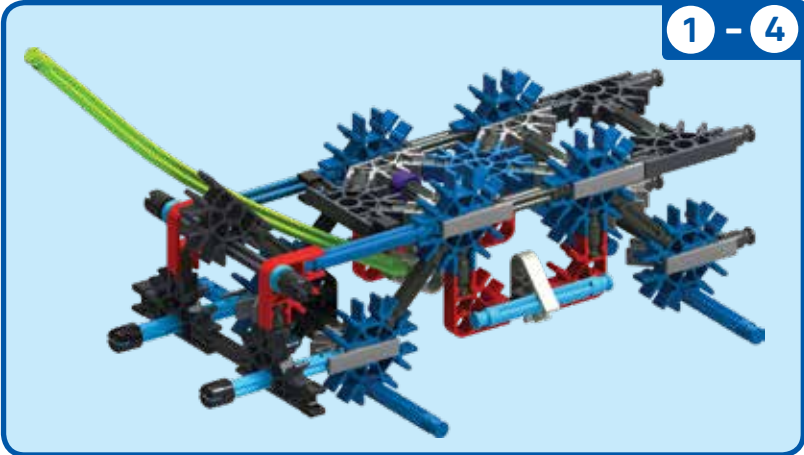



5

- 4
- 2
- 3
- 4
- 4
- 1
- 2
- 2
- 1
- 3

Rotate model

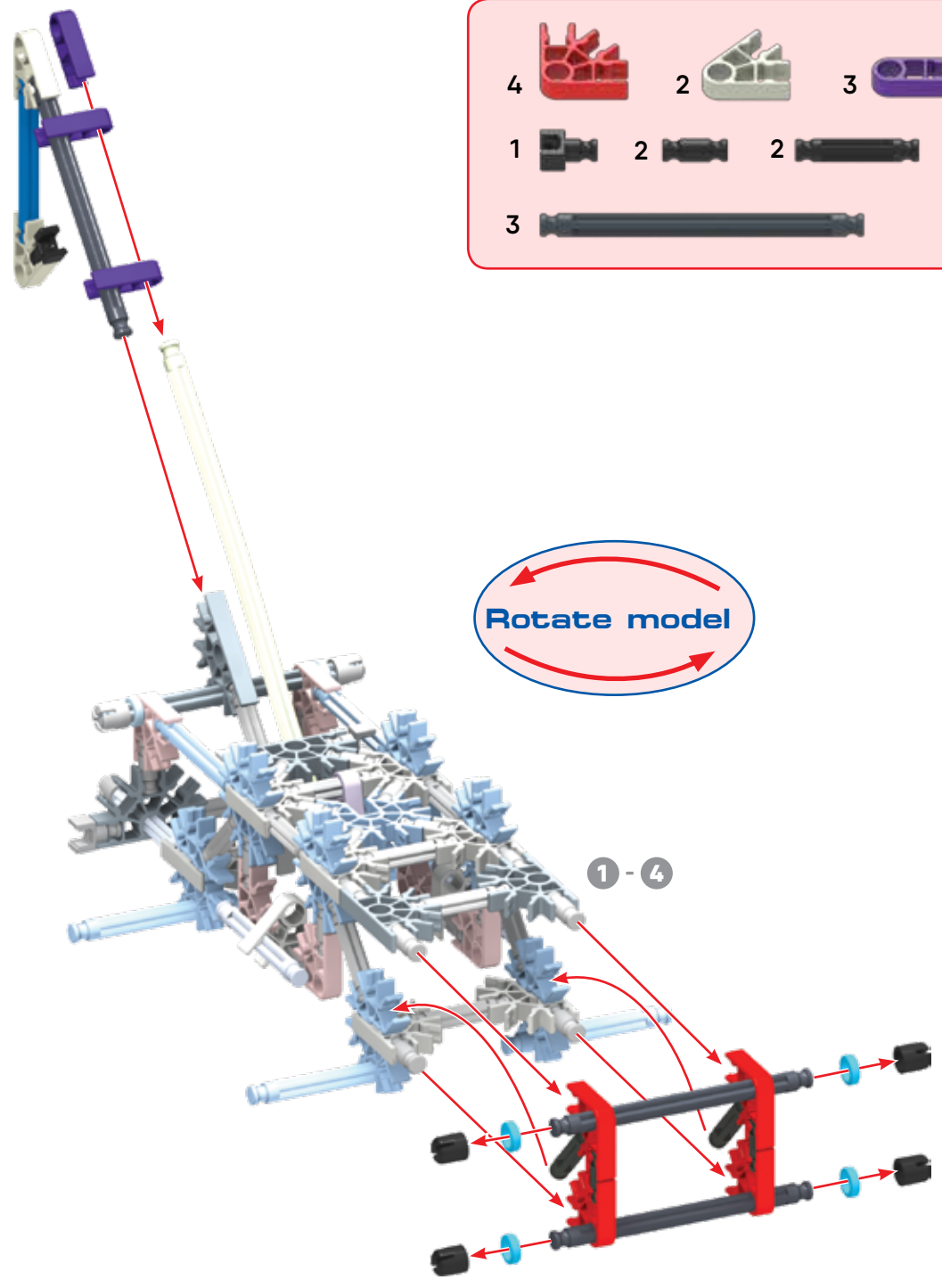

1 - 5

1 - 4

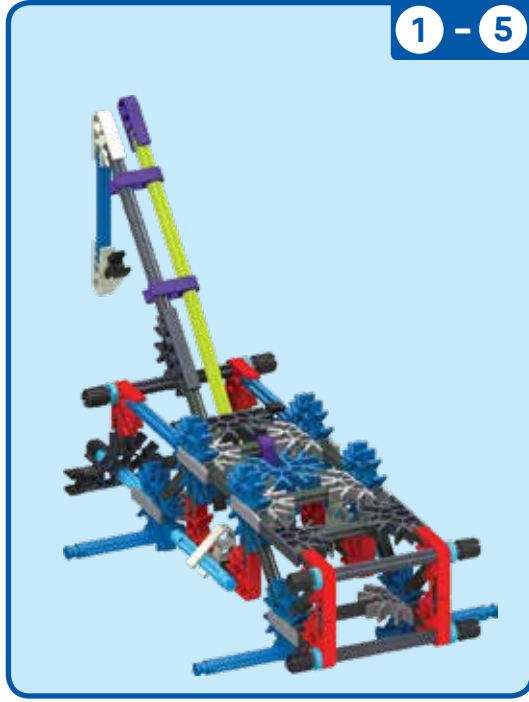

6

- 2 
- 2 
- 2 
- 6 
- 2 
- 4 
- 3 
- 2 
- 2 

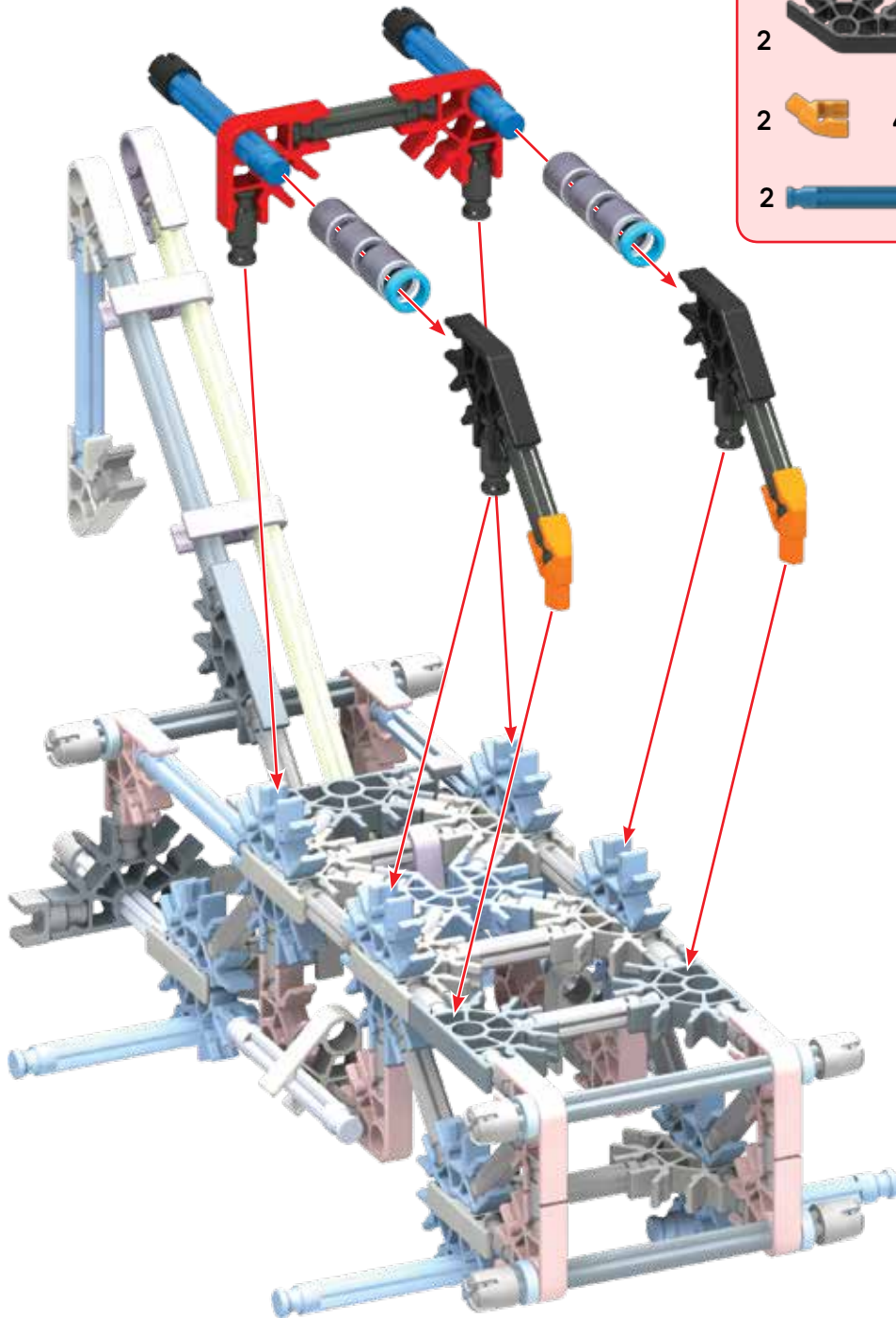

1 - 5

7

2 

4  4 

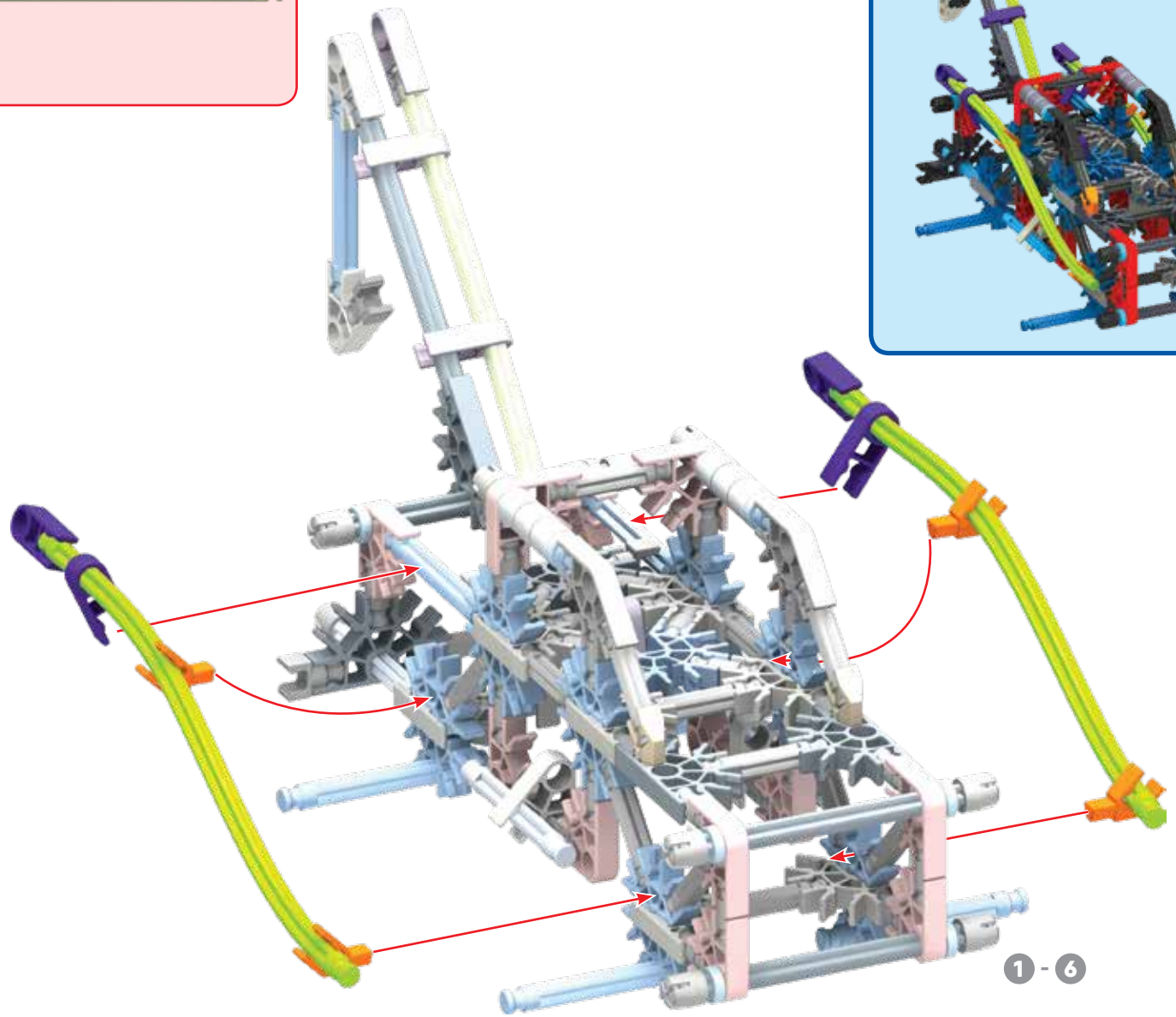

1 - 6

8

1 - 7

