

# K'nex

**SUPER VALUE TUB**  
Building Set

**MEGA BOX**  
Jeu de construction

**35** BUILDS  
MODÈLES

Ages  
**7-12**

12575

**⚠ WARNING:**  
CHOKING HAZARD – Toy contains small parts.  
Not for children under 3 years.

**⚠ ATTENTION :**  
RISQUE D'ÉTOUFFEMENT – Pièces de petite taille.  
Ne convient pas aux enfants de moins de 3 ans.



# IMAGINE™

\*\*Modelos  
Modelle  
Modelli  
Modelo  
Modellen

## Building Basics

## Bases de Construction

### Start Building

Each K'NEX piece has its own shape and color. Try to position your model in the same direction as the instructions. Faded colors show you this section is already built.

### Démarre ta Construction

Chaque K'NEX pièce a sa propre forme et sa propre couleur. Pour te faciliter la tâche, oriente le modèle dans le même sens que les instructions. Les pièces ayant une couleur estompée sont celles déjà assemblées.

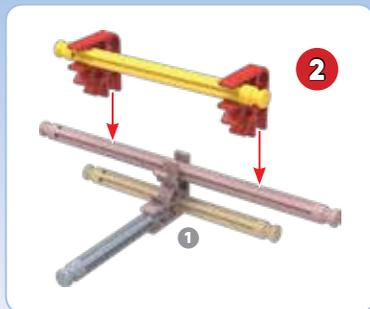
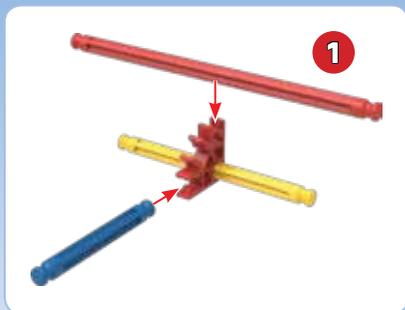

### Connectors

Push these special connectors together tightly until you hear a "click".

### Connecteurs

Pousse connecteurs spéciaux fort jusqu'à entendre un « clic ».

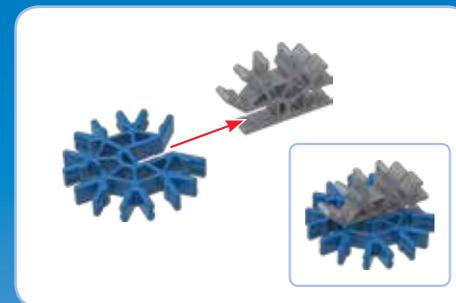
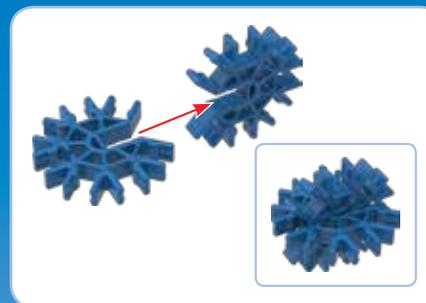

### Spacers

Be sure to use the correct color and number of spacers shown.

### Séparateurs

Assure toi d'utiliser la bonne nombre de séparateurs.



### Flexible Rods

You can bend a flexible rod to make curved shapes. It will be easier to attach to your model if you bend it back and forth a few times first.

### Tiges flexibles

Un Flexi-rod est une tige que tu peux courber pour faire des courbes. Elle pourra être attachée plus aisément à ton modèle si tu la plies en avant et en arrière plusieurs fois.



# (EN) CONTENTS

PARROT .....	4
BATTLESHIP .....	4
ELEPHANT .....	5
PICK-UP TRUCK.....	6
HELICOPTER .....	7
DINOSAUR .....	10
MOTORCYCLE.....	12
3 WHEELED CYCLE.....	14
HOT ROD.....	17
FERRIS WHEEL.....	22
BUILDING IDEAS.....	26

# (FR) CONTENU

PERROQUET .....	4
NAVIRE CUIRASSÉ .....	4
ÉLÉPHANT.....	5
CAMION DE COLLECTE.....	6
HÉLICOPTÈRE.....	7
DINOSAUR .....	10
MOTO .....	12
CICLETA DE 3 RUEDAS .....	14
HOT-ROD .....	17
GRANDE ROUE .....	22
IDÉES DE CONSTRUCTION .....	26



**WARNING: CHOKING HAZARD** – Small parts. Not for children under 3 years.

**ATTENTION : RISQUE D'ÉTOUFFEMENT** – Pièces de petite taille. Ne convient pas aux enfants de moins de 3 ans.

**ADVERTENCIA: PELIGRO DE ASFIXIA** – Piezas pequeñas. No para niños menores de 3 años.

**ACHTUNG: ERSTICKUNGSGEFAHR** – Kleinteile. Nicht geeignet für Kinder unter 3 Jahren.

**AVVISO: PERICOLO DI SOFFOCARE** – Pezzi piccoli. Non adatto per bambini sotto 3 anni.

**AVISO: PERIGO DE SUFOCAÇÃO** – Peças pequenas. Não se destina a crianças com menos de 3 anos de idade.

**WAARSCHUWING: INSLIKKINGSGEVAAR** – Kleine onderdelen. Niet geschikt voor kinderen jonger dan 3 jaar.

**CAUTION:** Keep hands, face, hair and clothing away from all moving parts.

**ATTENTION :** Garde les cheveux, les doigts, la figure et les vêtements à l'écart de toutes les pièces mobiles.

**PRECAUCIÓN:** Mantén el cabello, los dedos, la cara y la ropa alejada de las piezas móviles.

**VORSICHT:** Haare, Finger, Gesicht und Kleidungsstücke nicht mit beweglichen Teilen in Berührung kommen lassen.

**ATTENZIONE:** Tenere i capelli, le dita, il viso e i vestiti lontano da tutte le parti in movimento.

**CUIDADO:** Mantém o cabelo, os dedos, a cara e a roupa afastados de todas as peças móveis.

**LET OP:** Hou het haar, de vingers, het gezicht en kledij verwijderd van alle bewegende onderdelen.

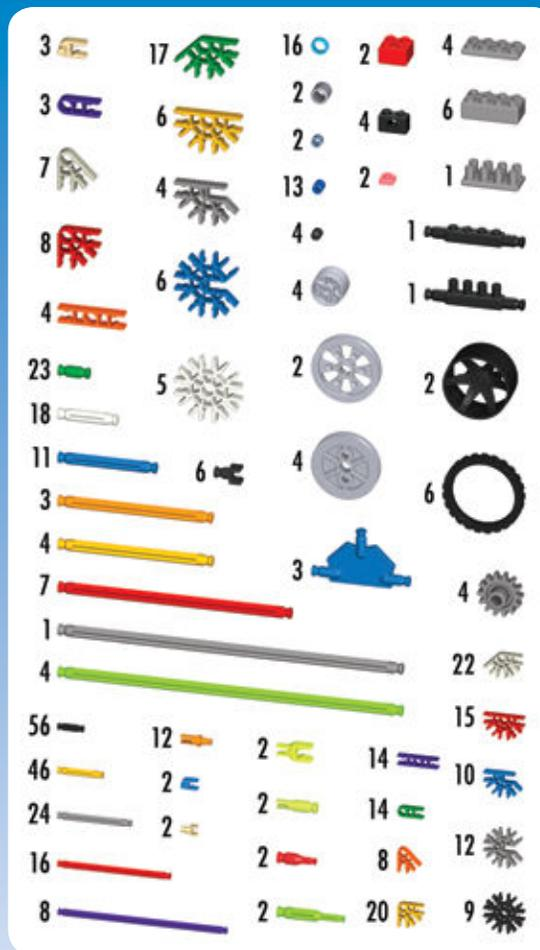

## Parts List

Before you start building, be sure to compare the parts in your set with the parts list here. If anything is missing call or write to us using the information on the back cover. We're here to help you!

## Liste des pièces

Avant de commencer à construire, assure-toi de comparer les pièces dans ta boîte à la liste de pièces fournie ici. S'il manque quelque chose, téléphone-nous ou écris-nous en te servant des informations figurant au verso de la notice. Nous sommes là pour t'aider.

**Parrot**  
**Perroquet**  
**Loro**

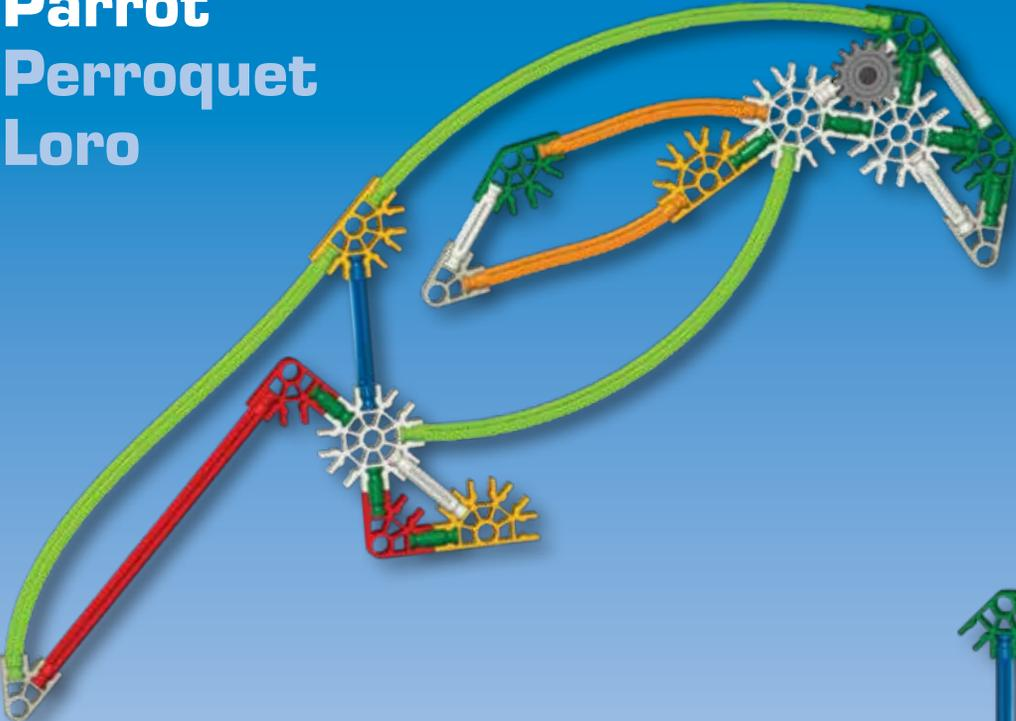

**Battleship**  
**Navire cuirassé**  
**Nave de Batalla**

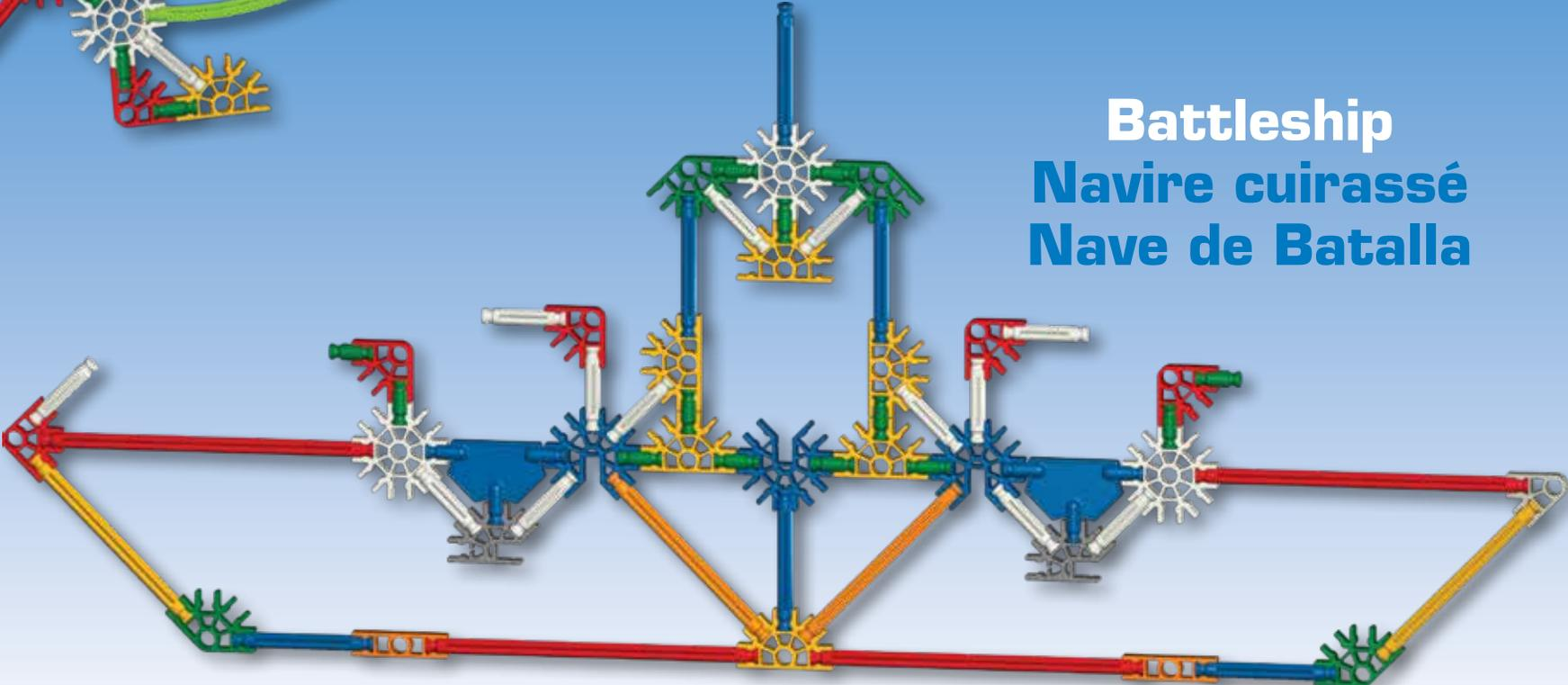

# Elephant Éléphant Elefante

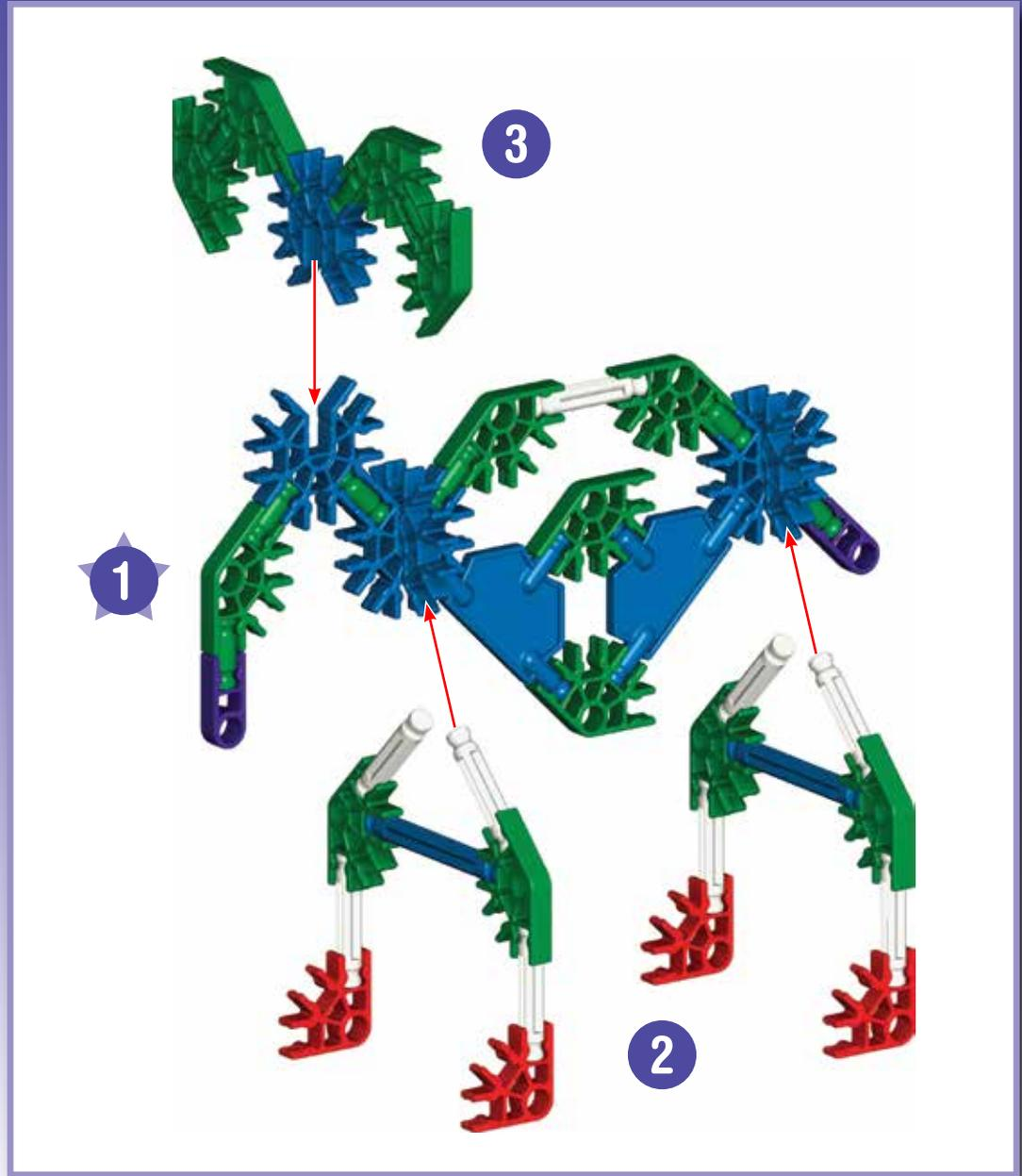
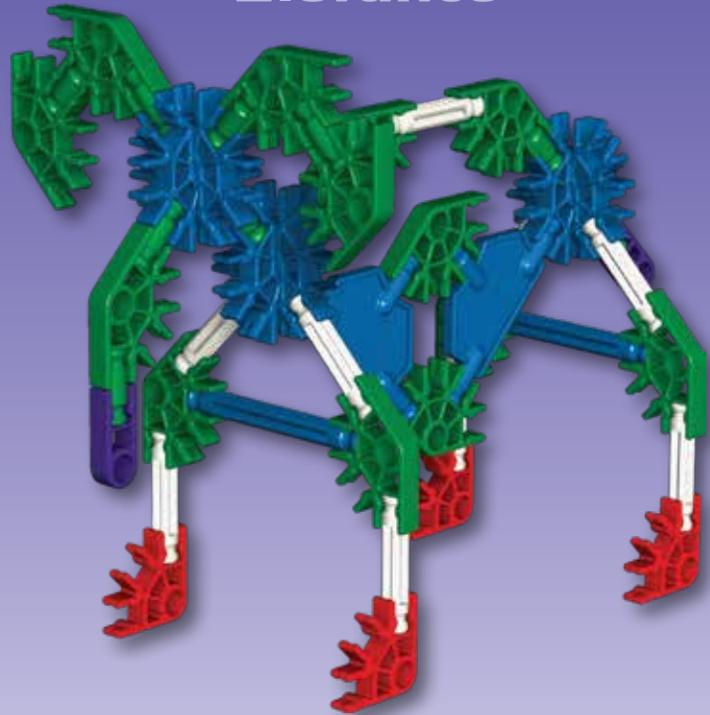

# Pick-Up Truck

## Camion de Colecte

### Carro de Recolección

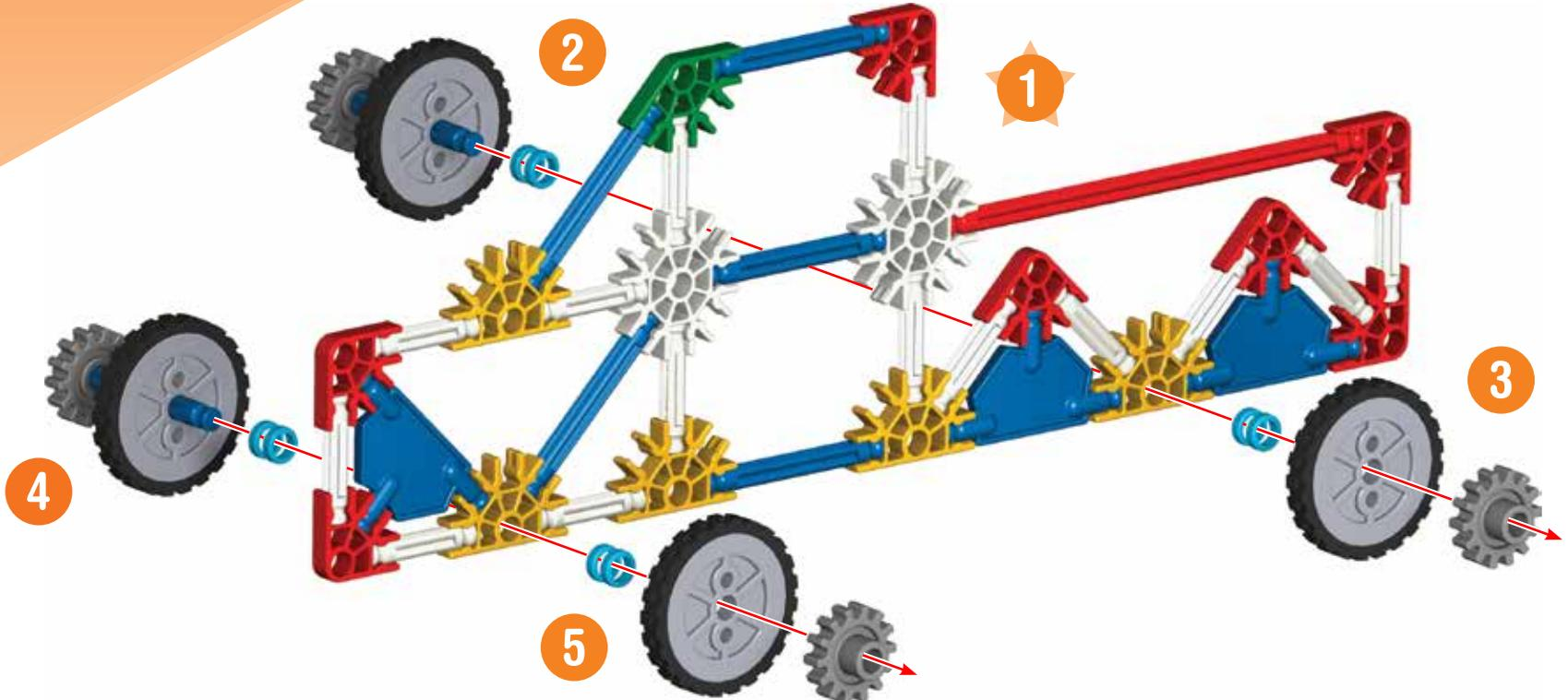



**Helicopter**  
**Hélicoptère**  
**Helicóptero**

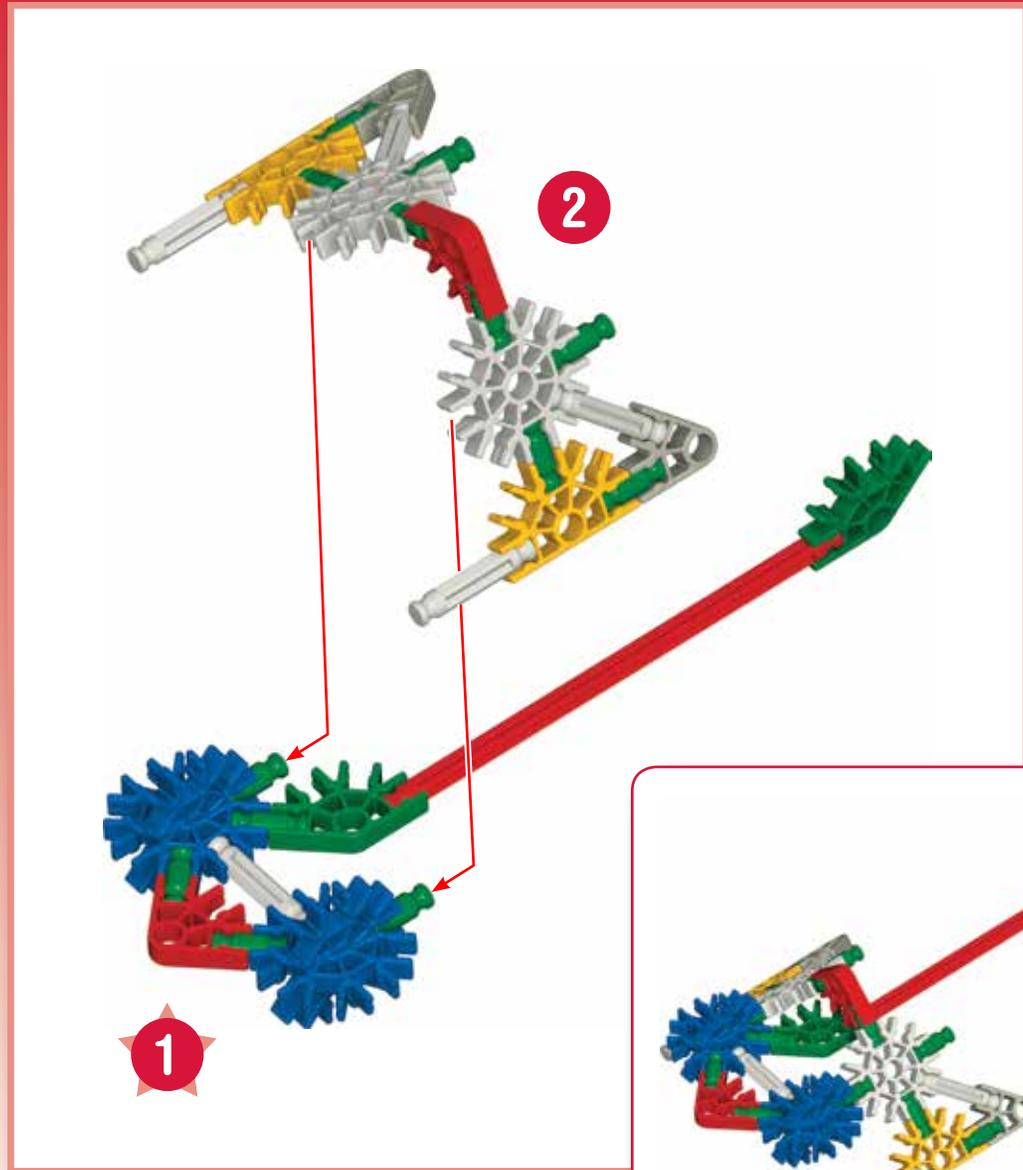

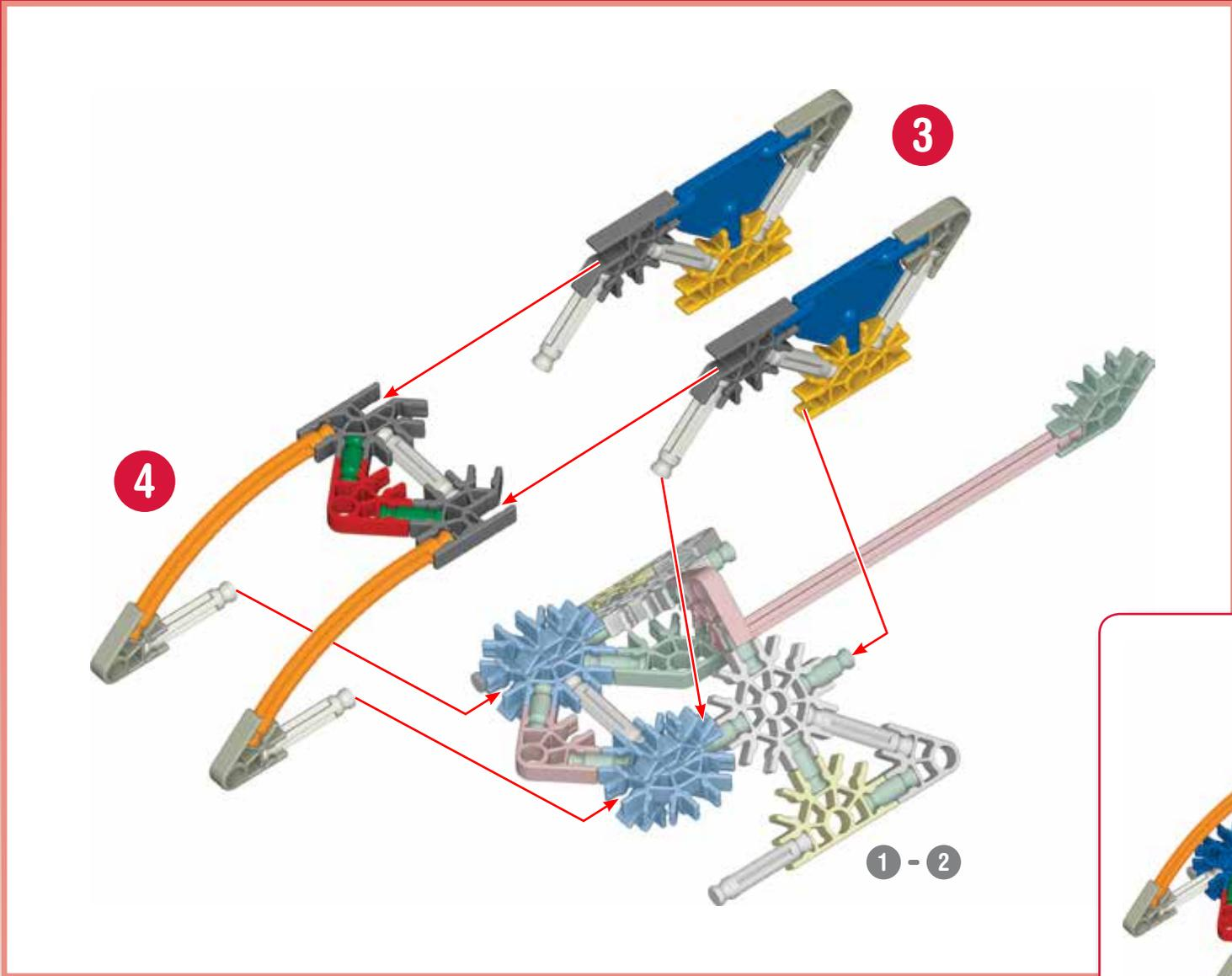

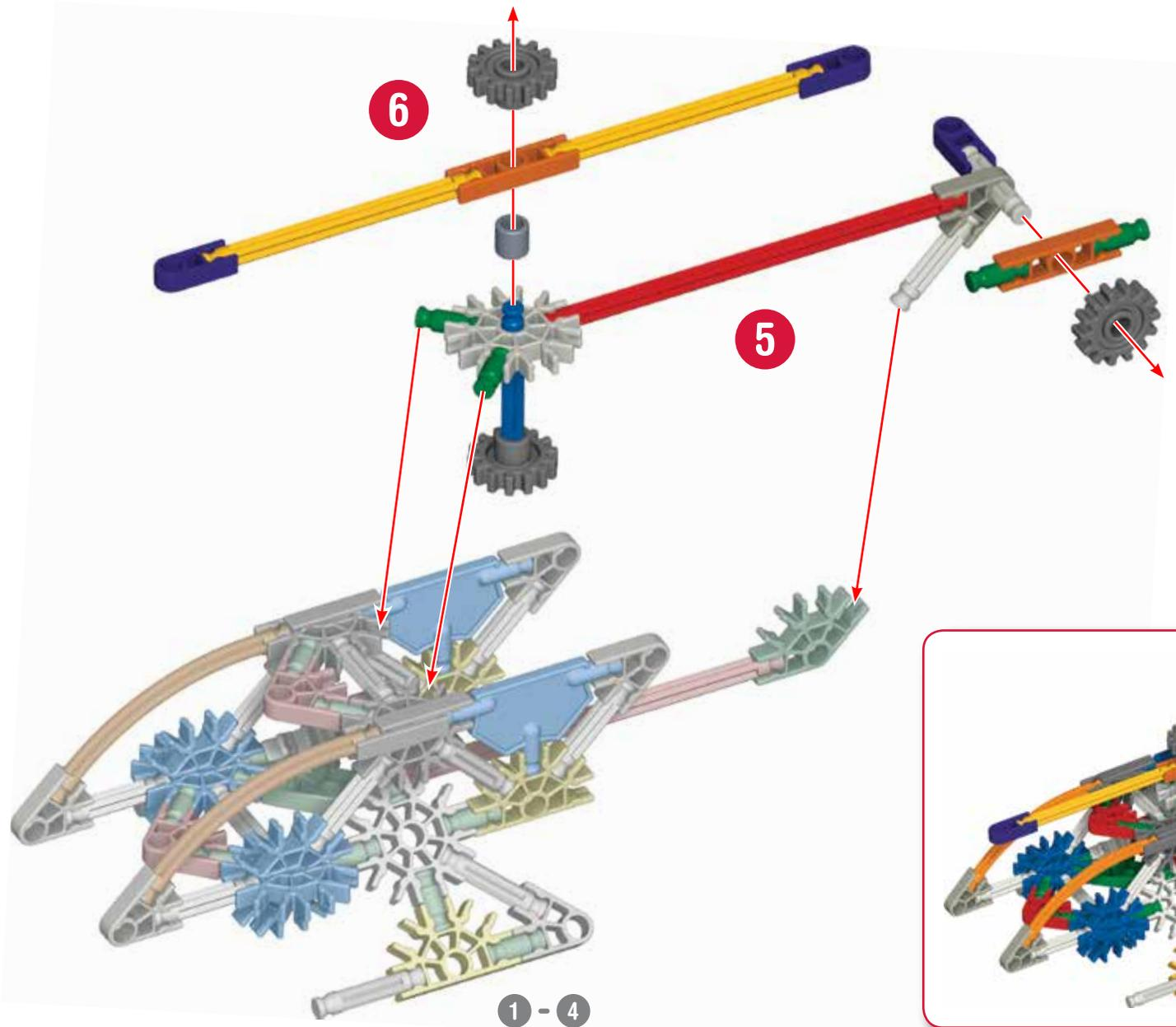

# Dinosaur Dinosaur Dinosaurio

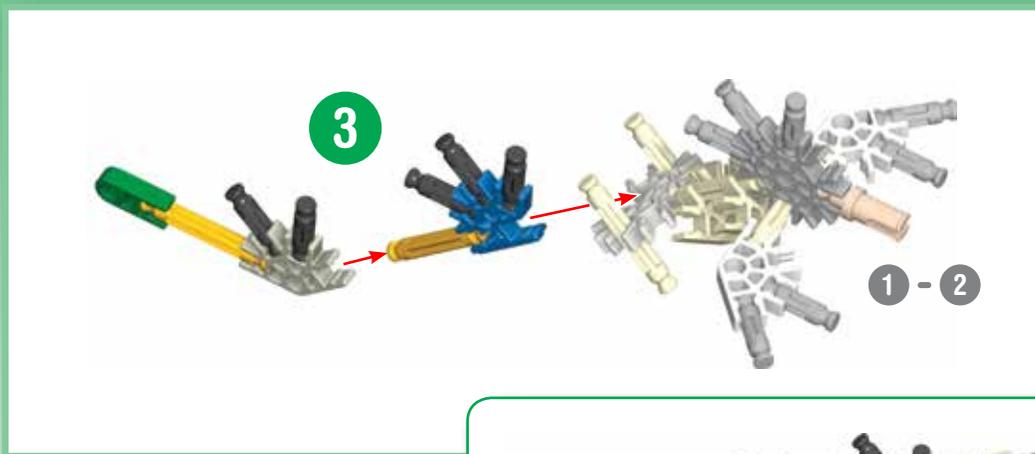
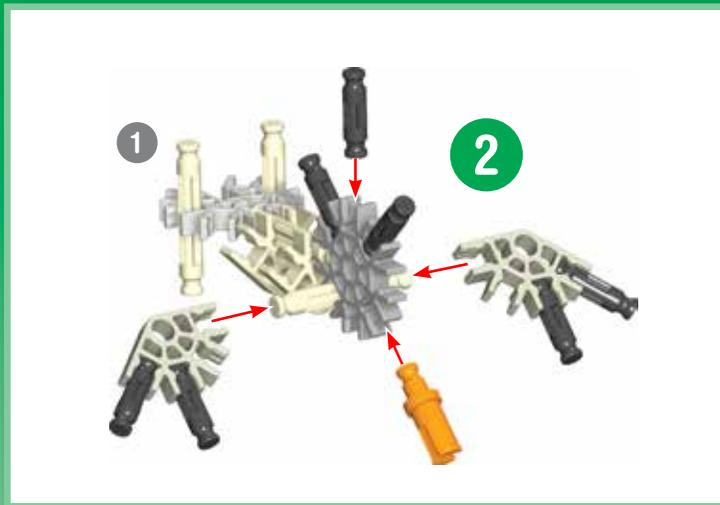
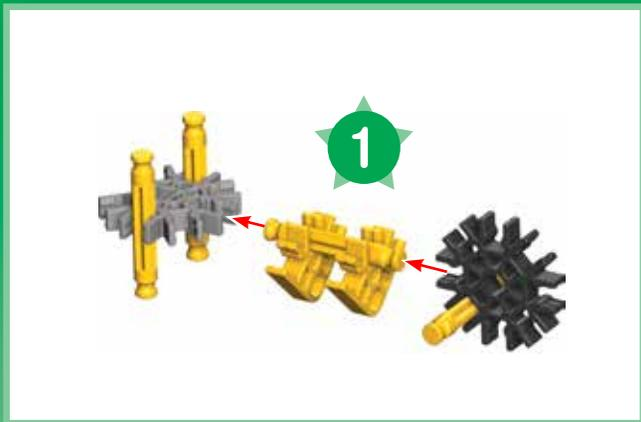
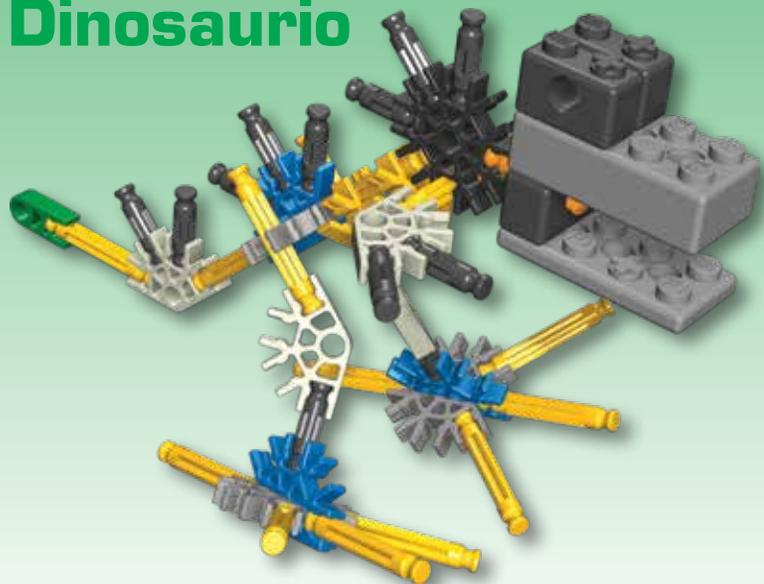

1 - 4



1 - 4

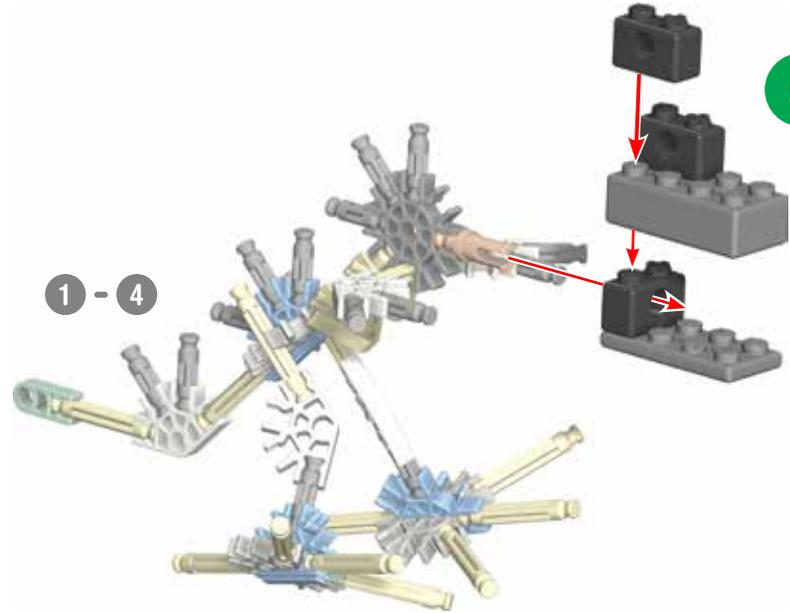

5

1 - 3

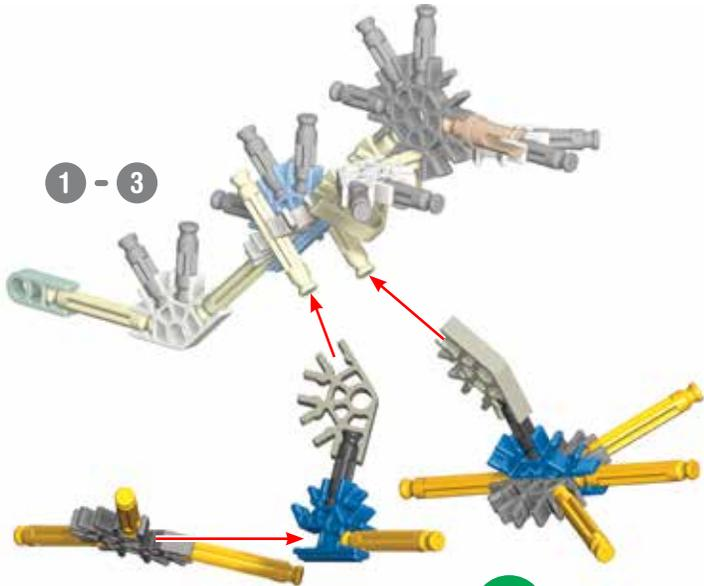

4

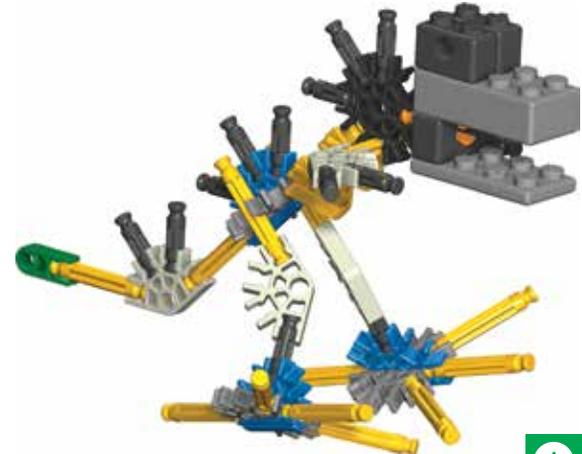

1 - 5

# Motorcycle

## Moto

## Motocicleta

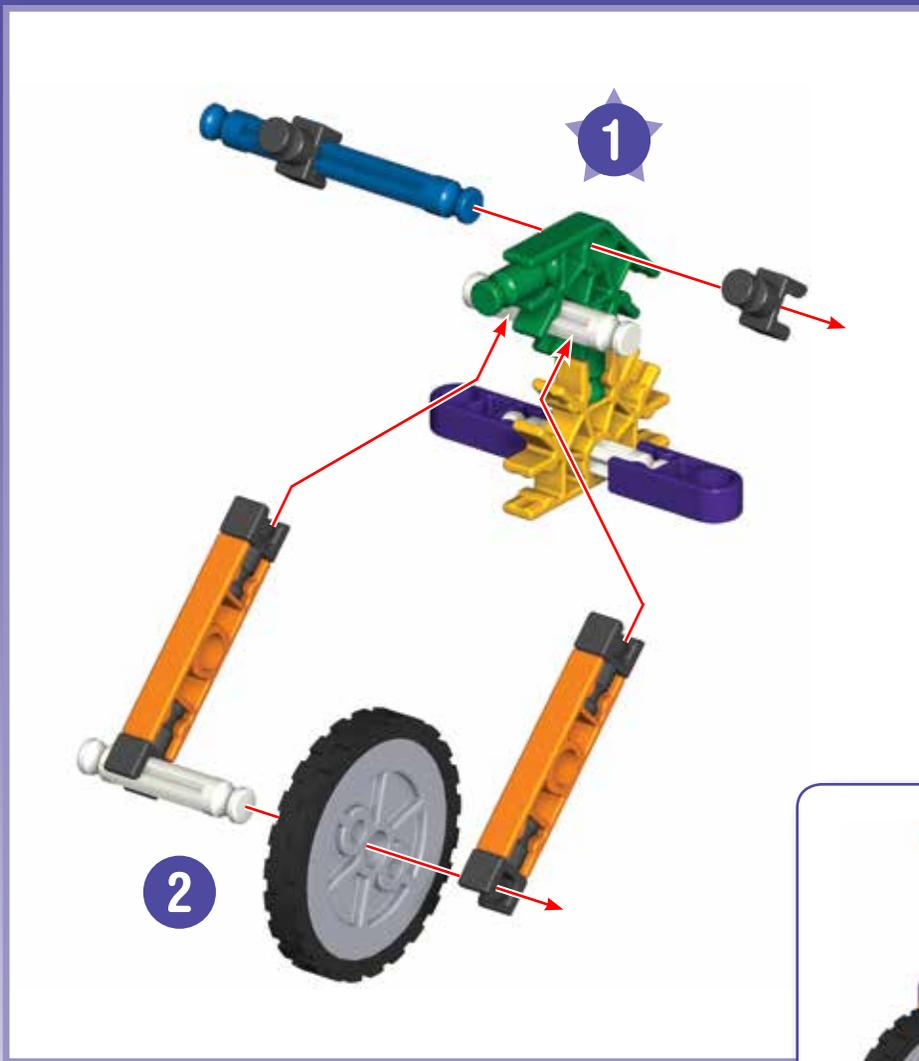
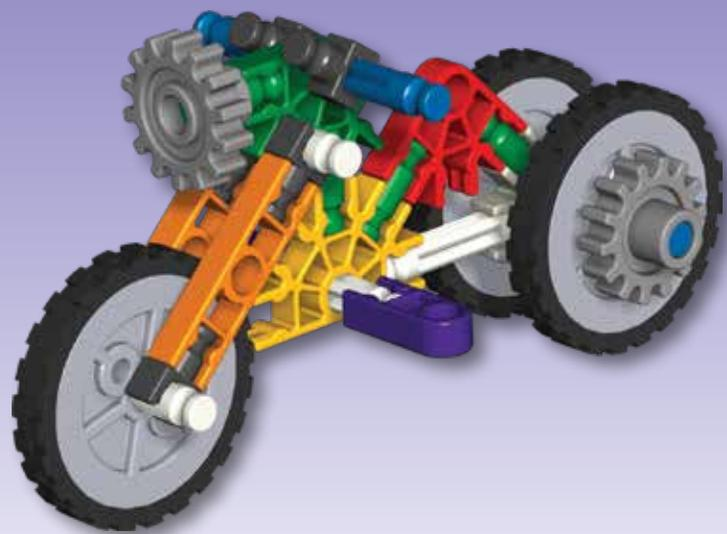

2



1 - 2

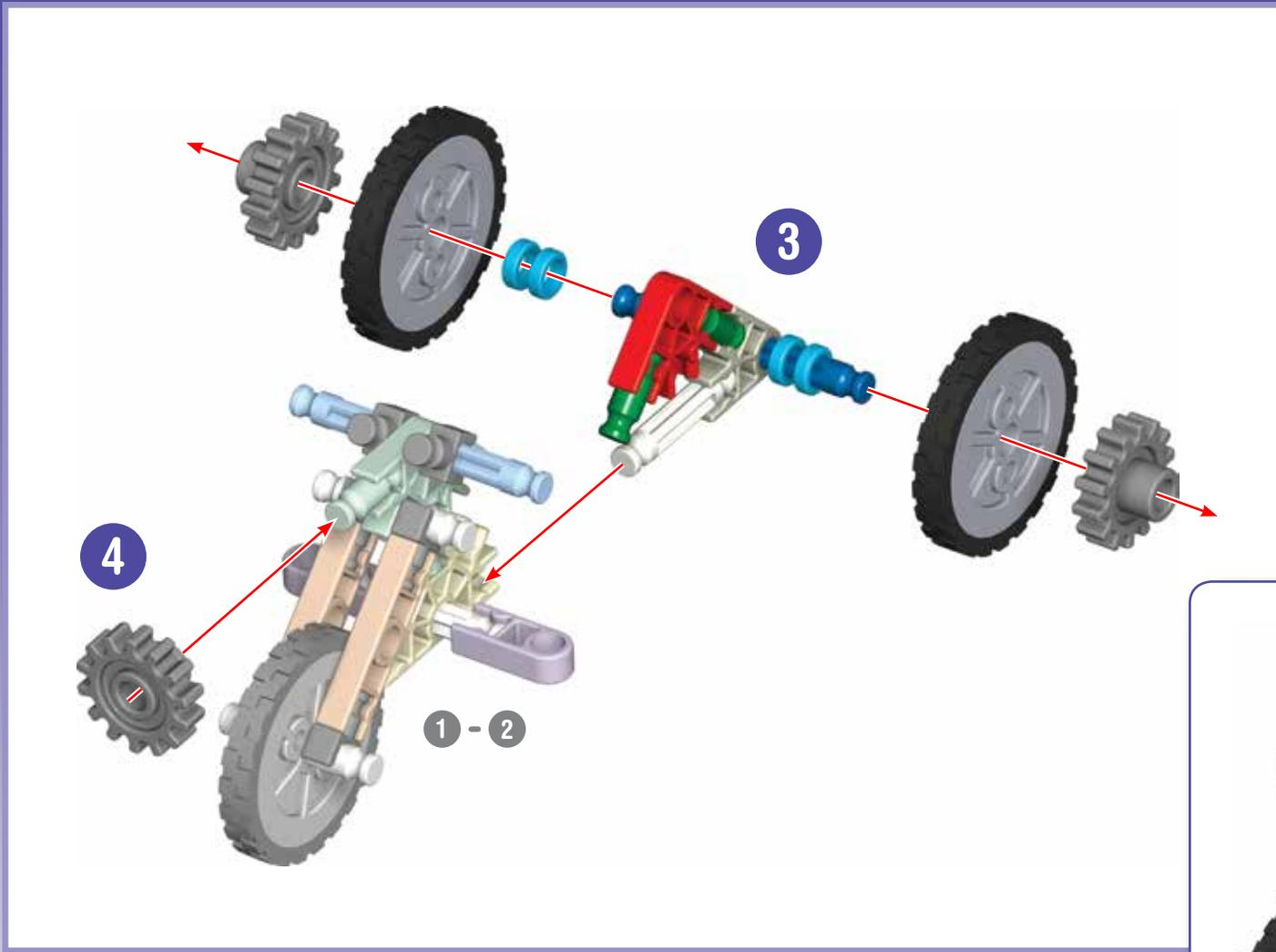

# 3 Wheeled Cycle

Cicleta de 3 Ruedas  
Moto de 3 Roues

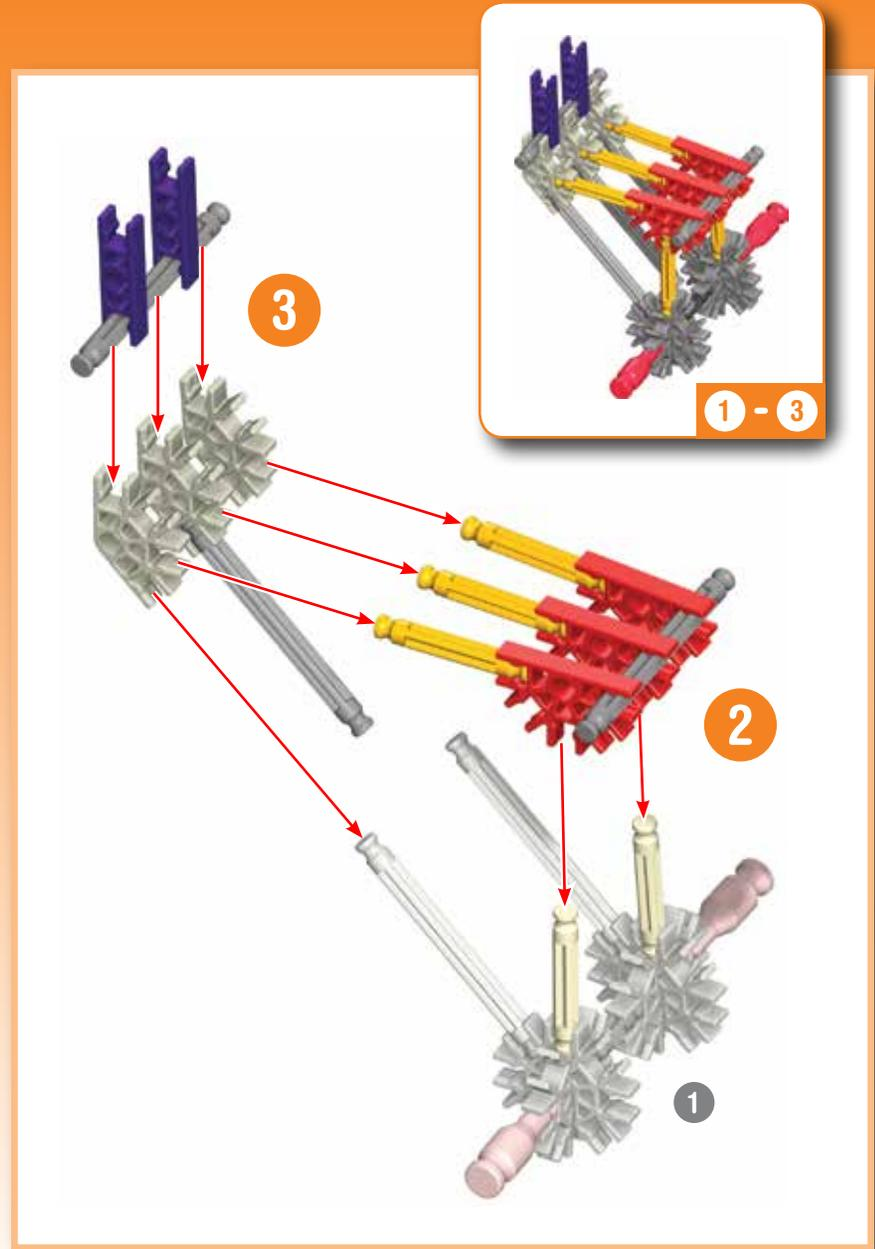
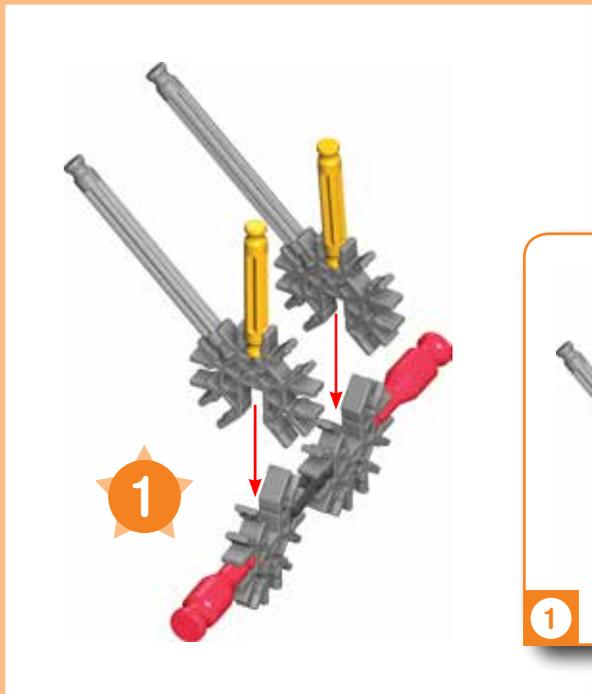

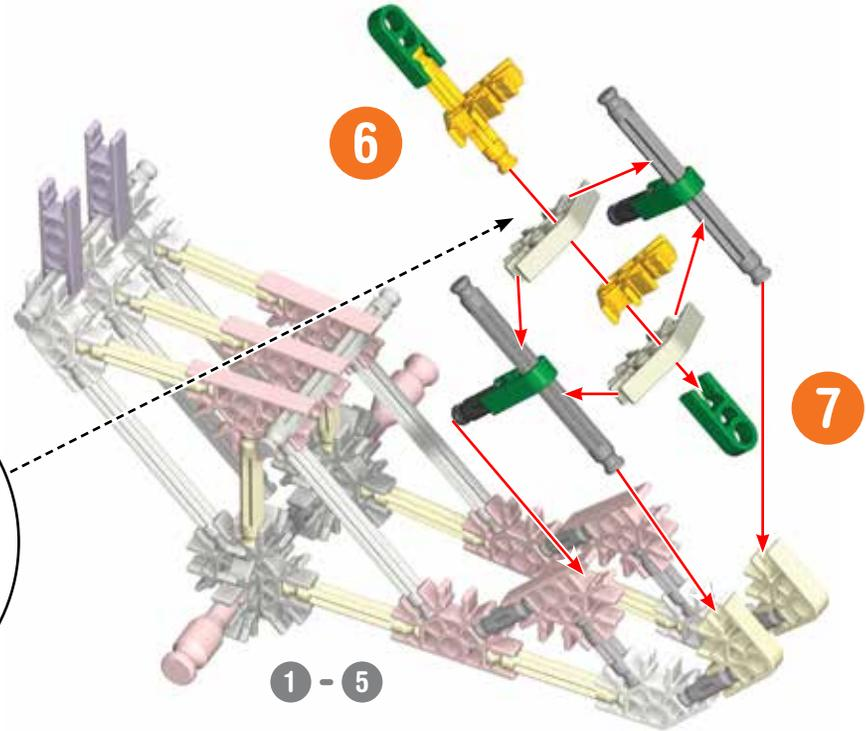
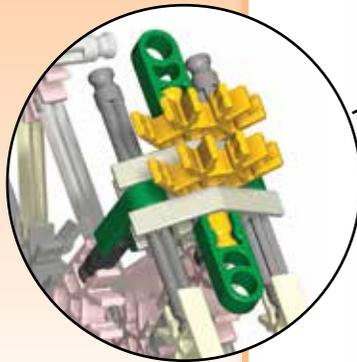
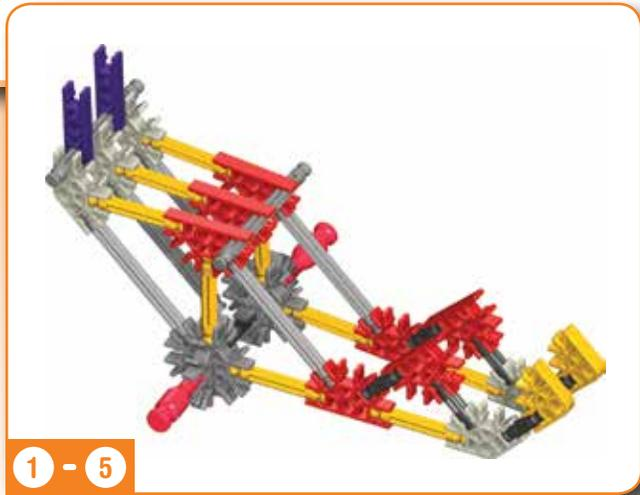
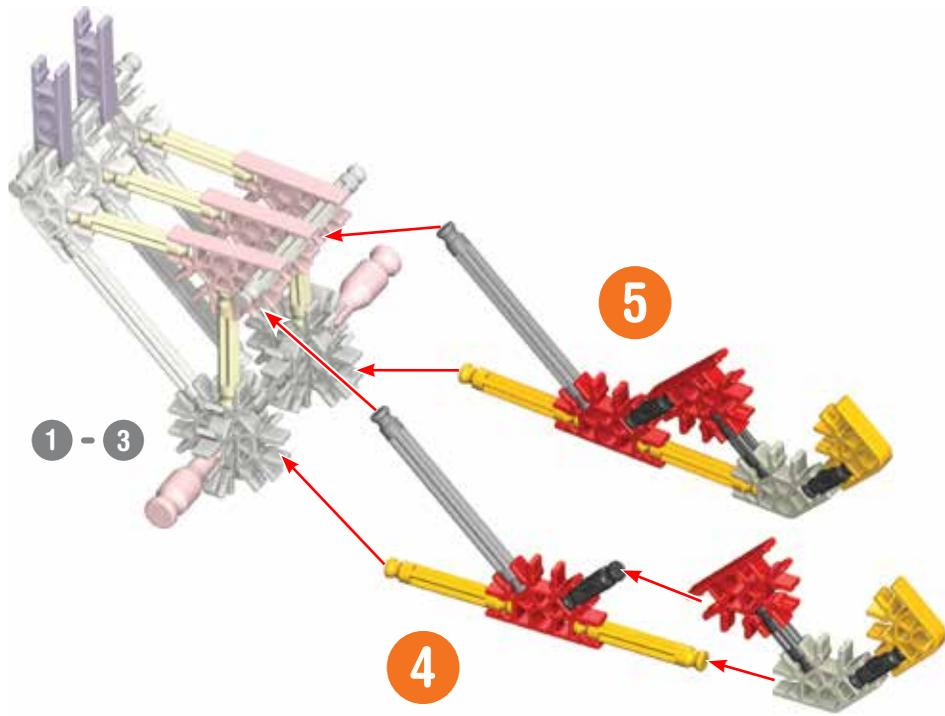

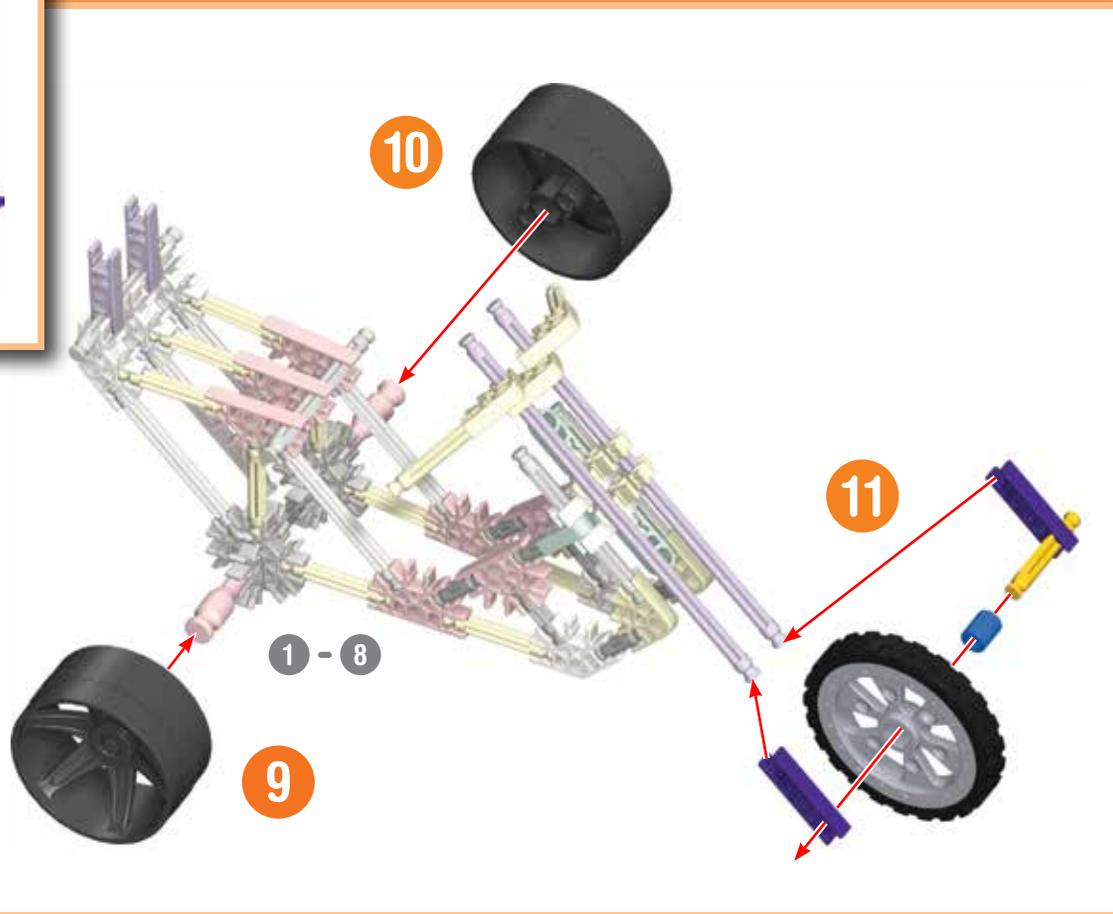
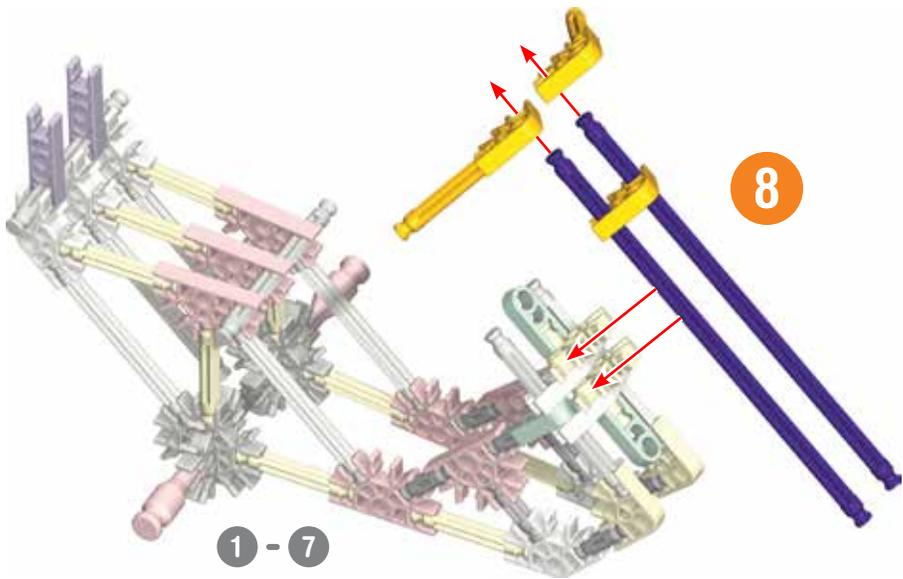

# Hot Rod Hot-Rod Bólide

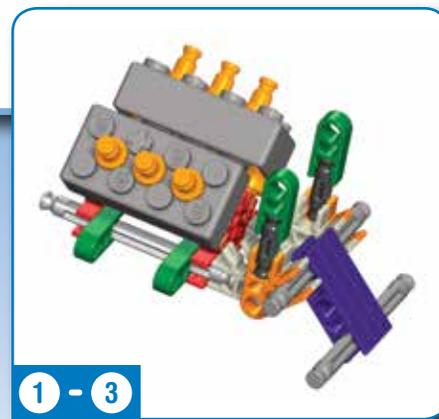
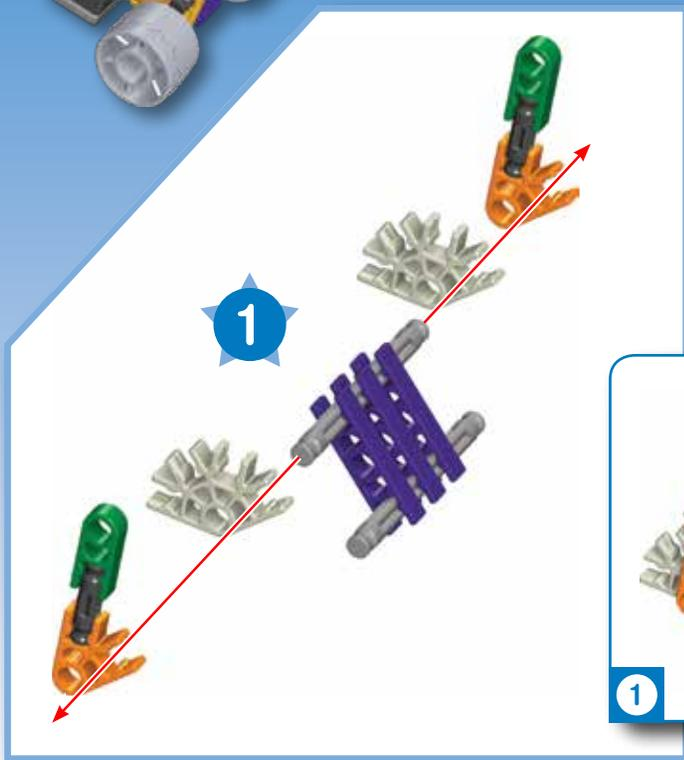
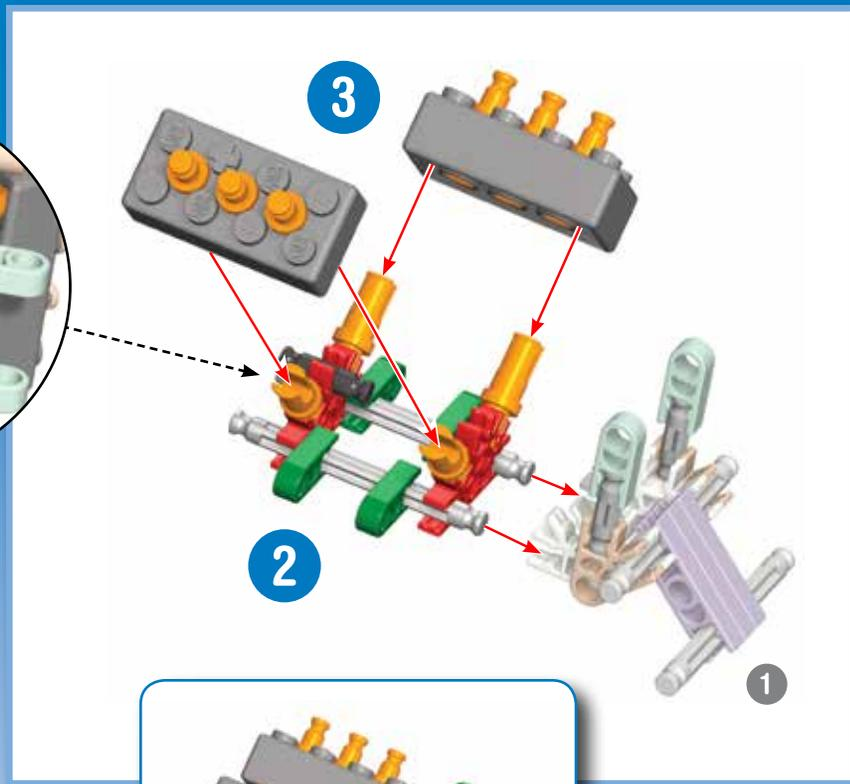
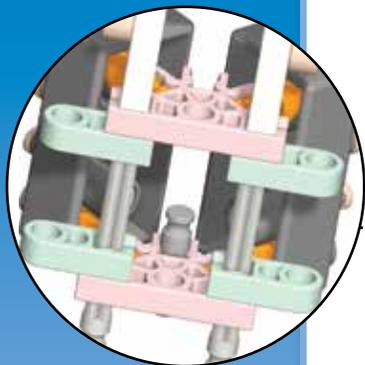

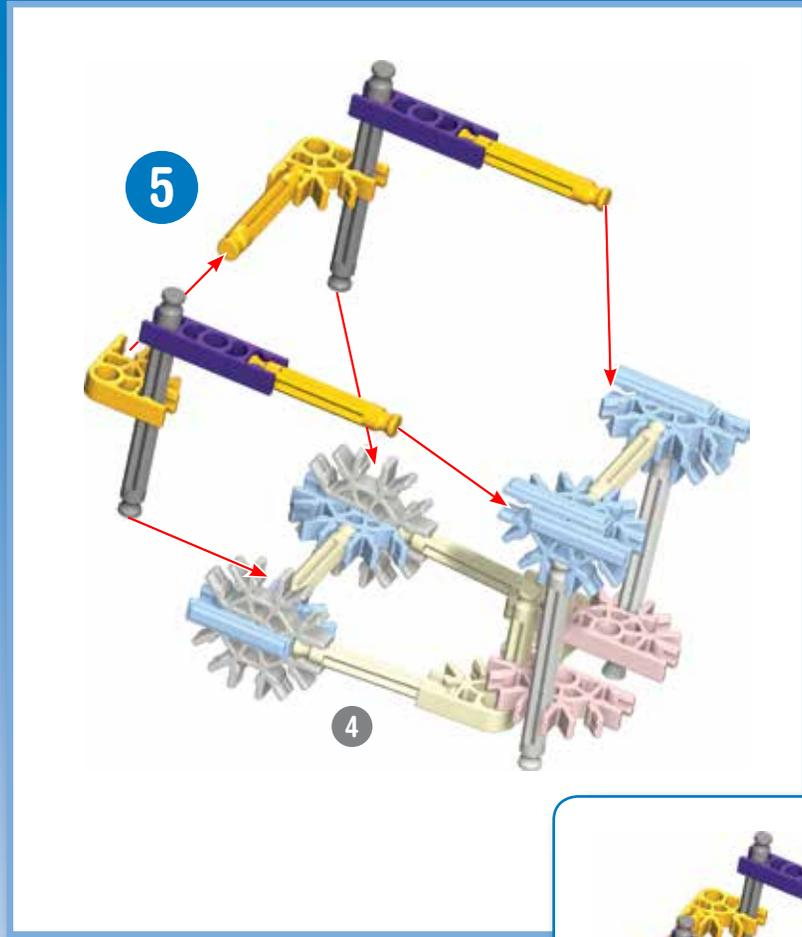
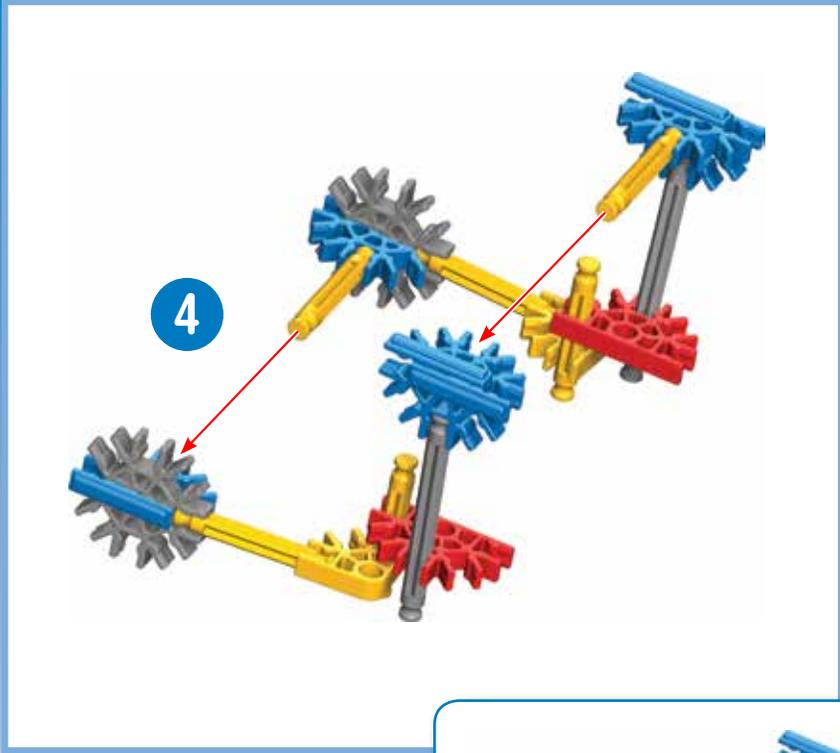

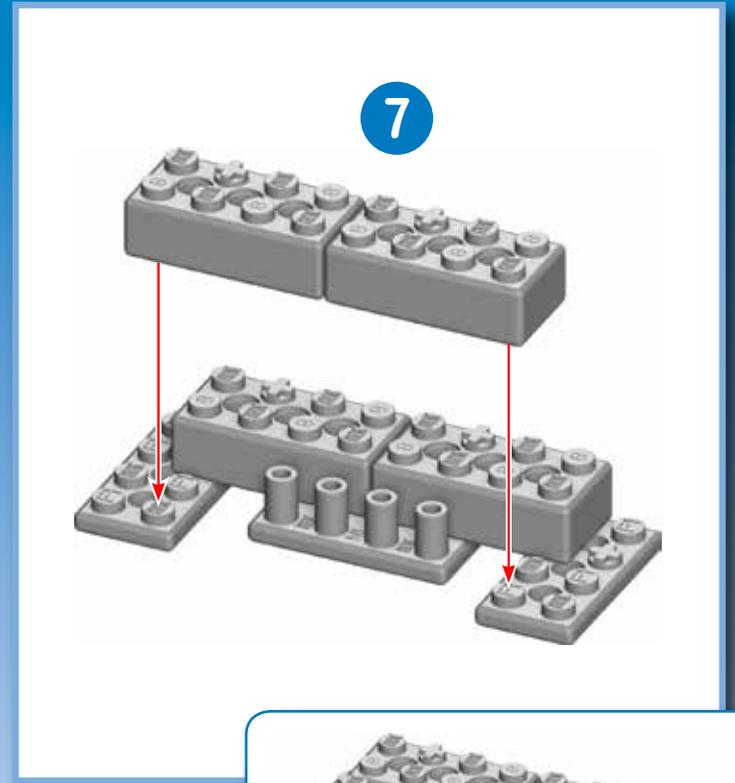
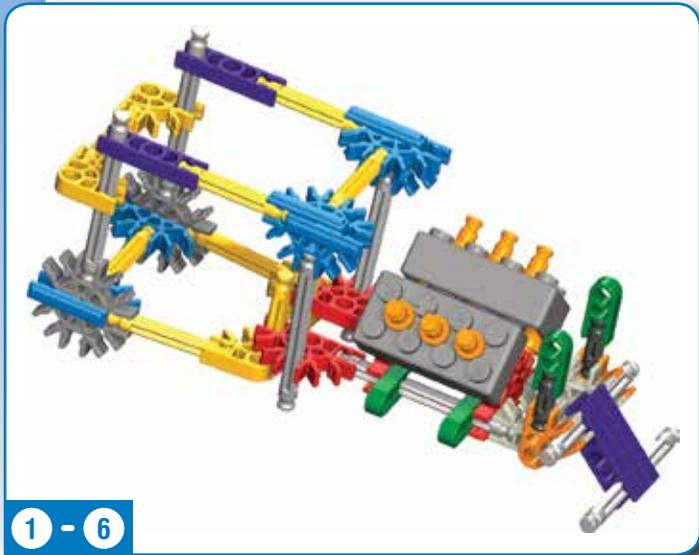
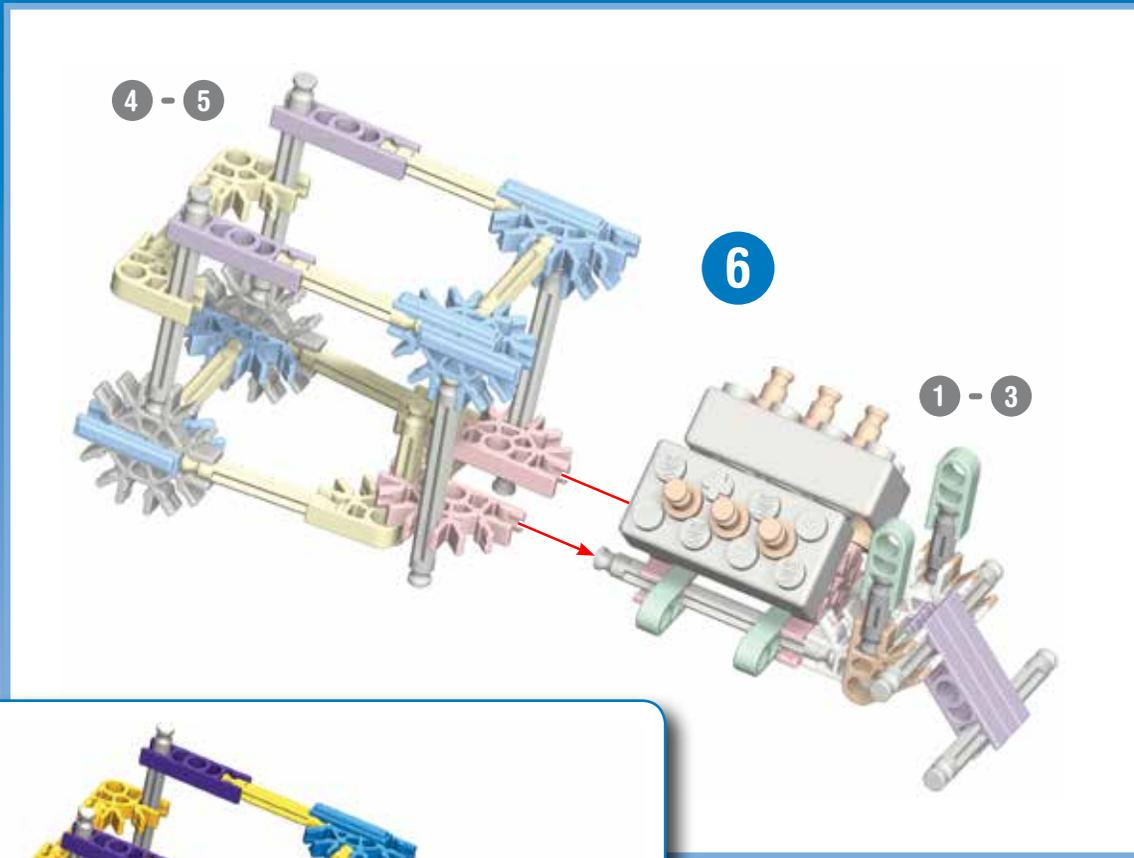

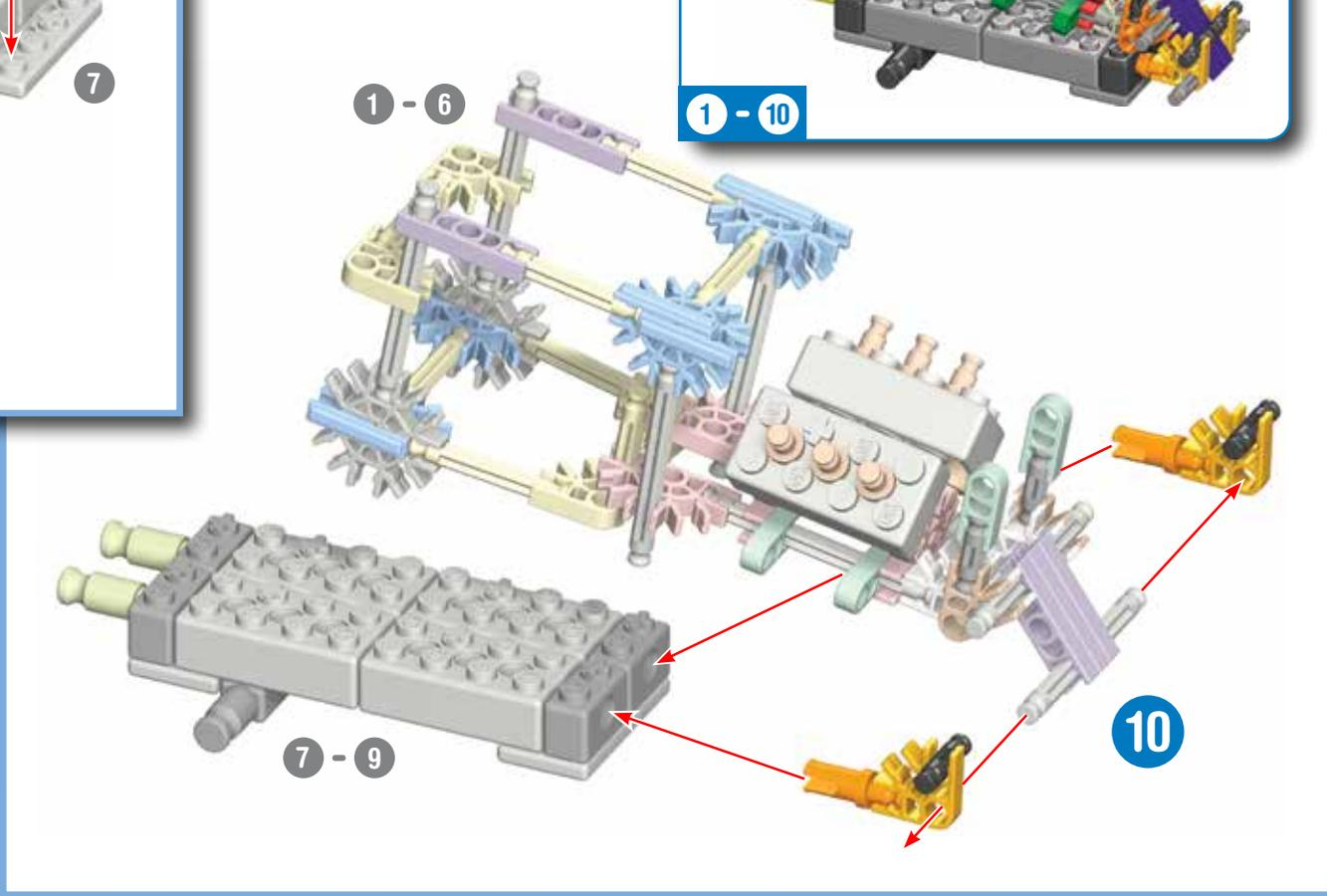
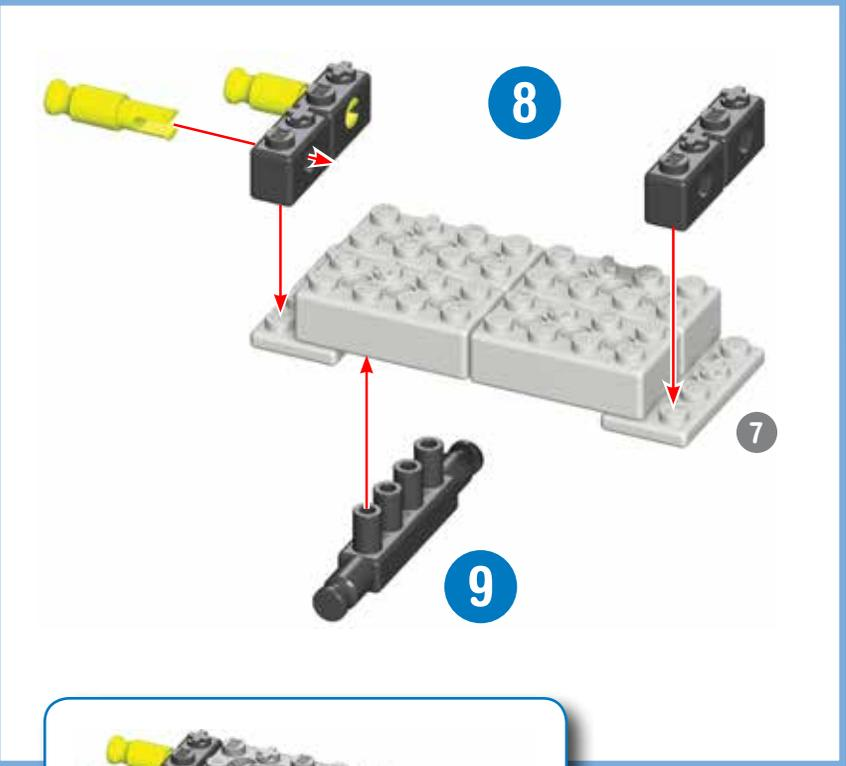

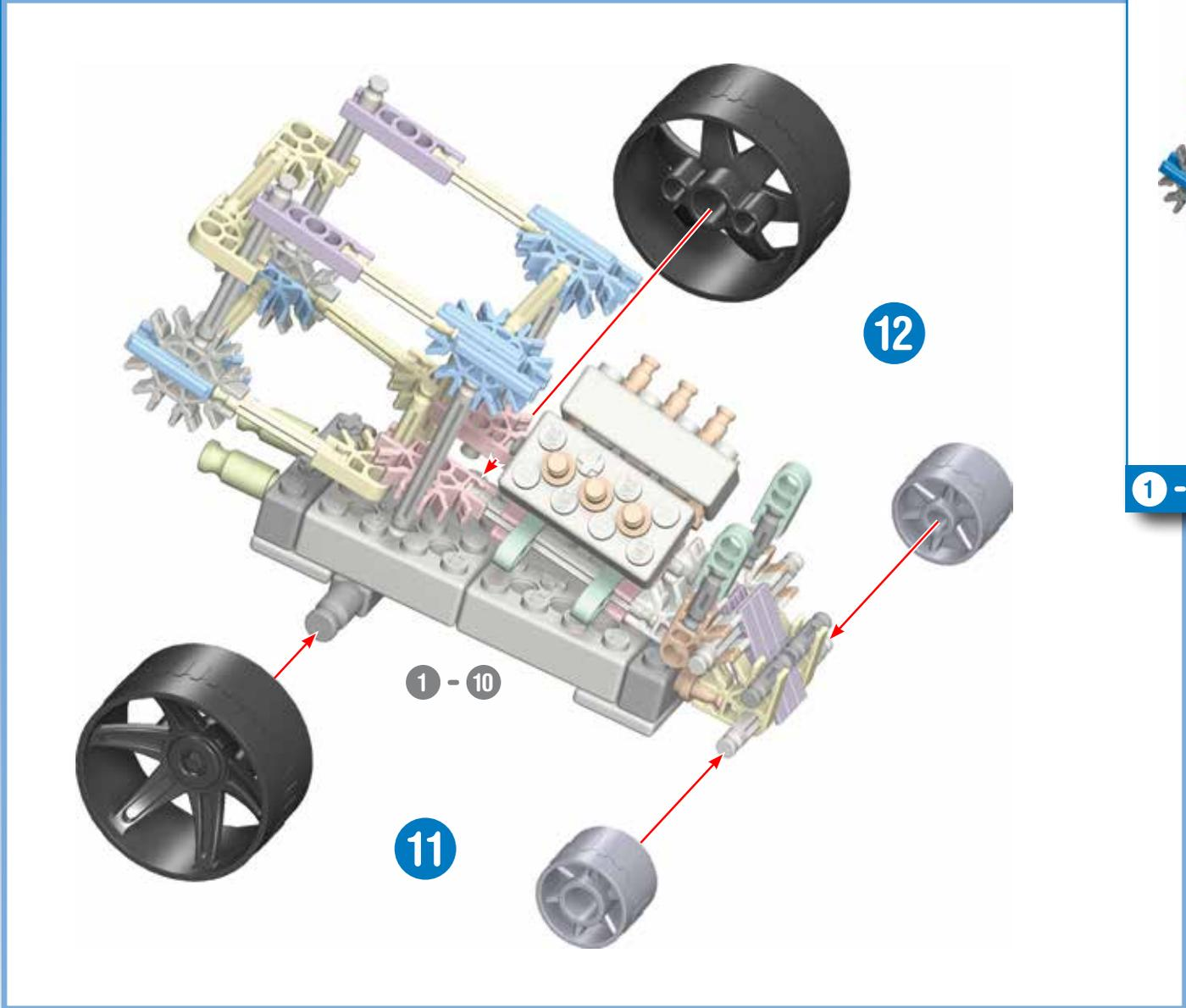

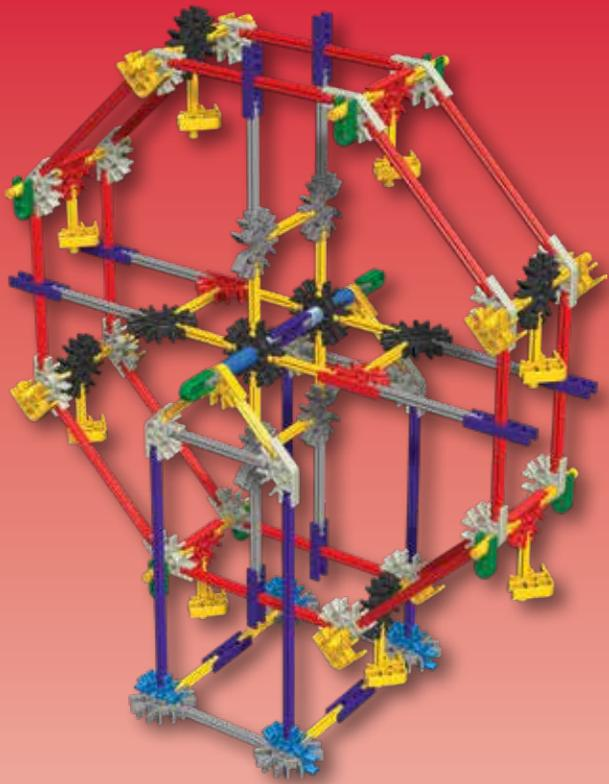

**Ferris Wheel**  
**Grande Roue**  
**Rueda de Ferris**

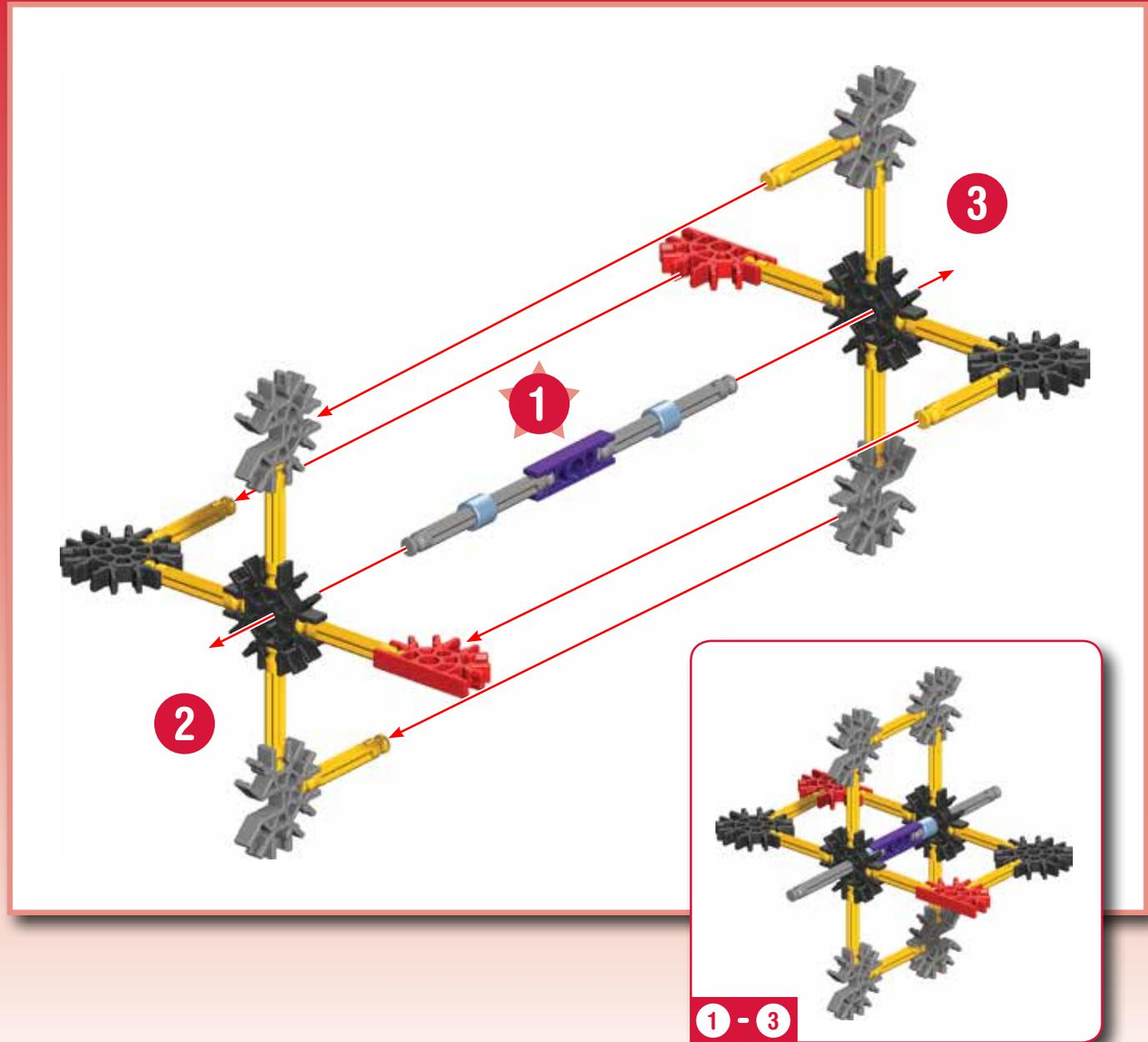

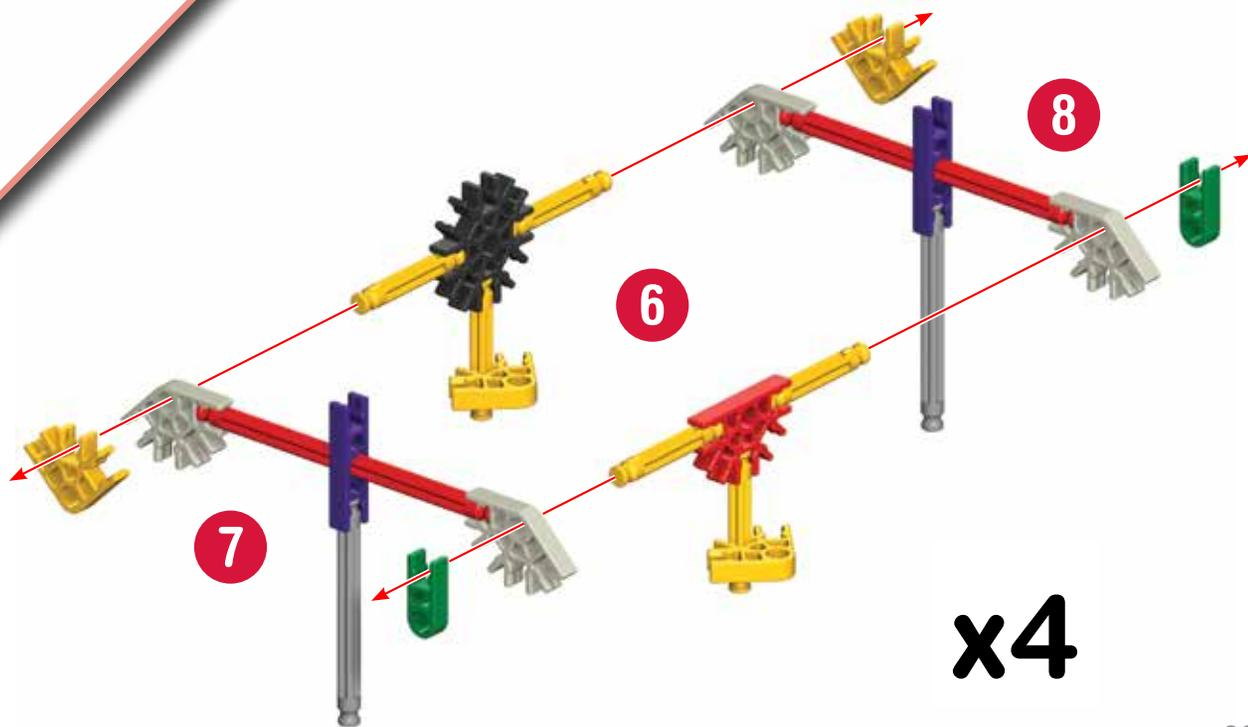
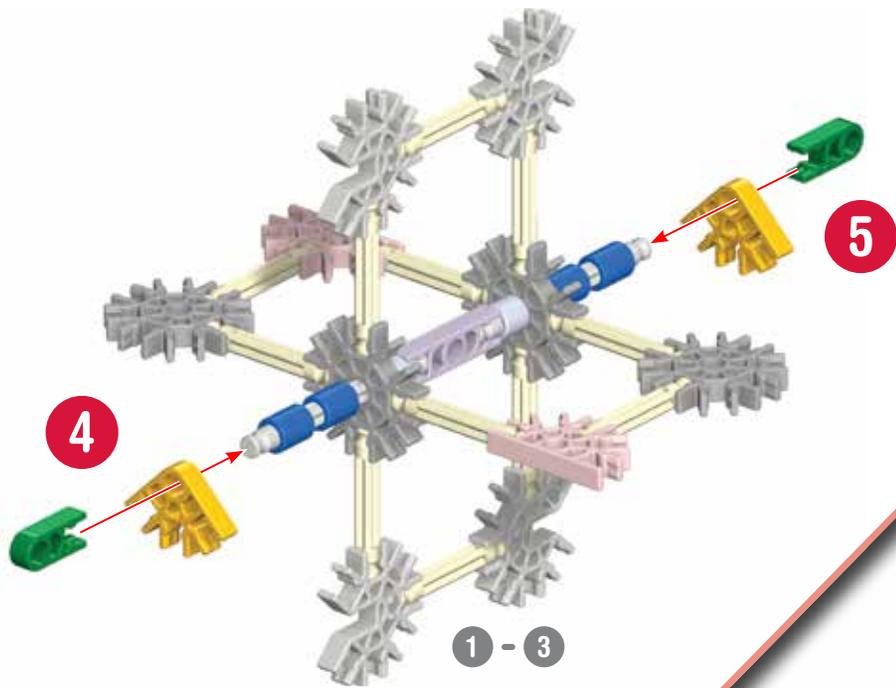

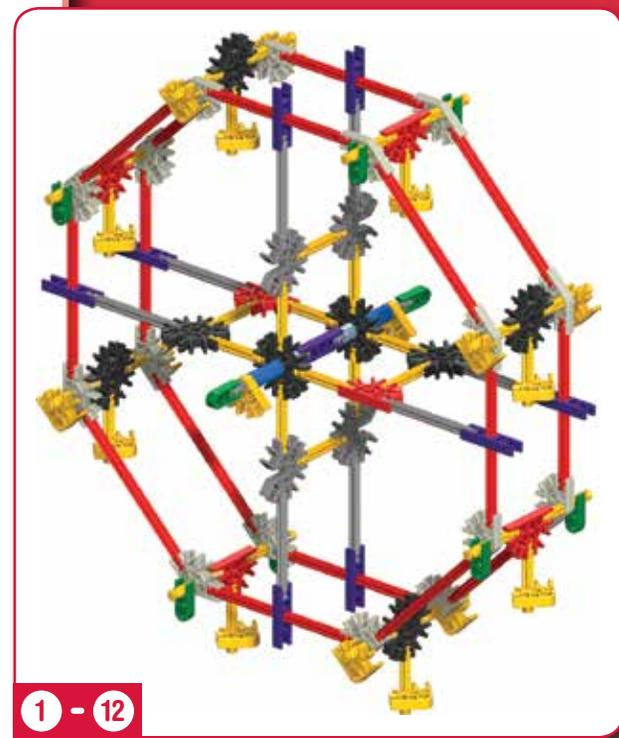
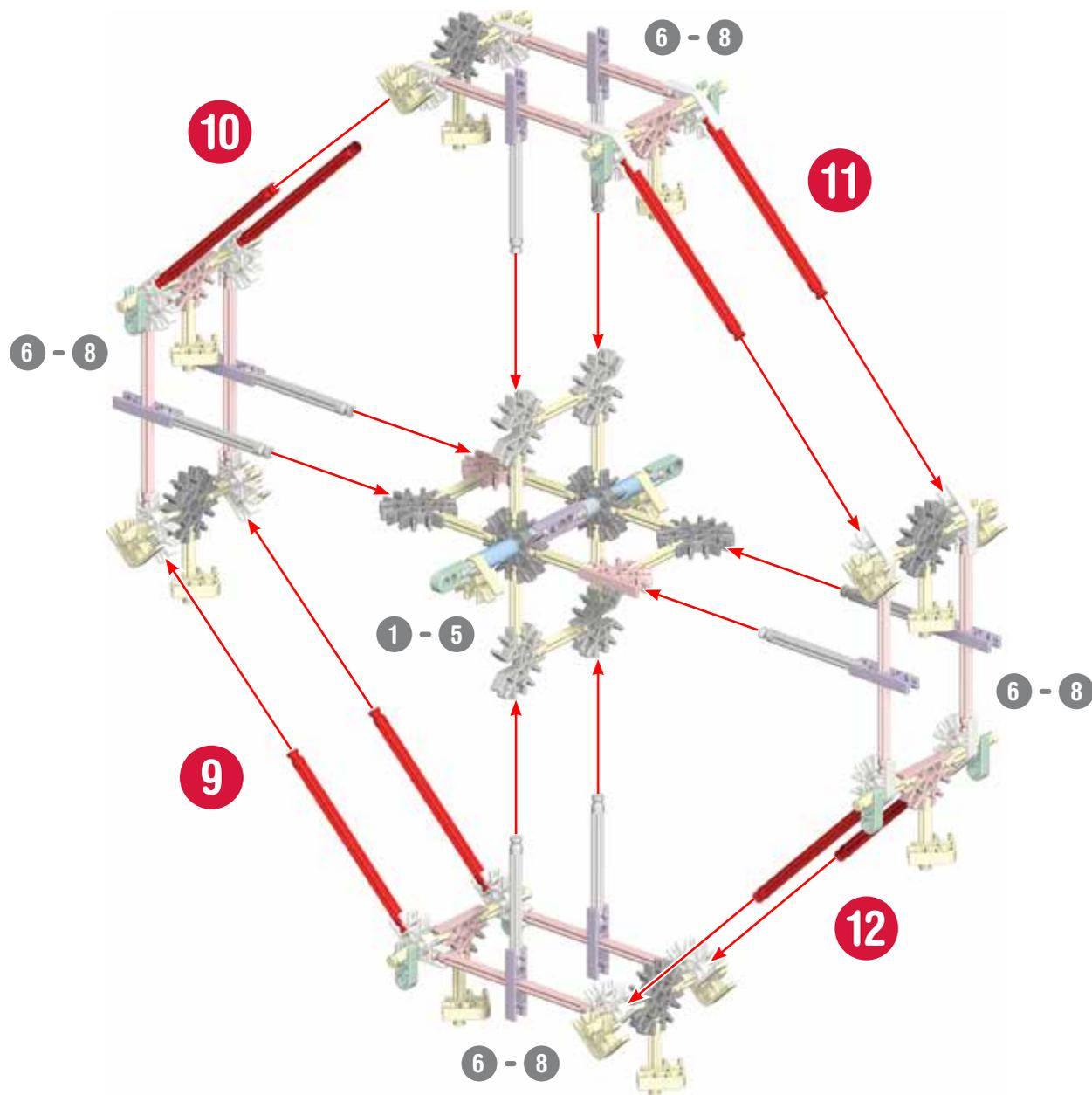

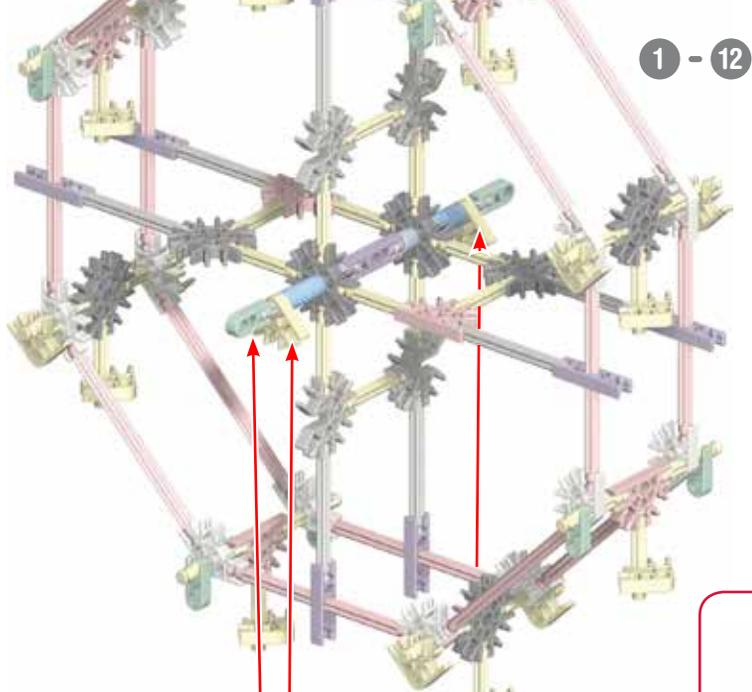

13

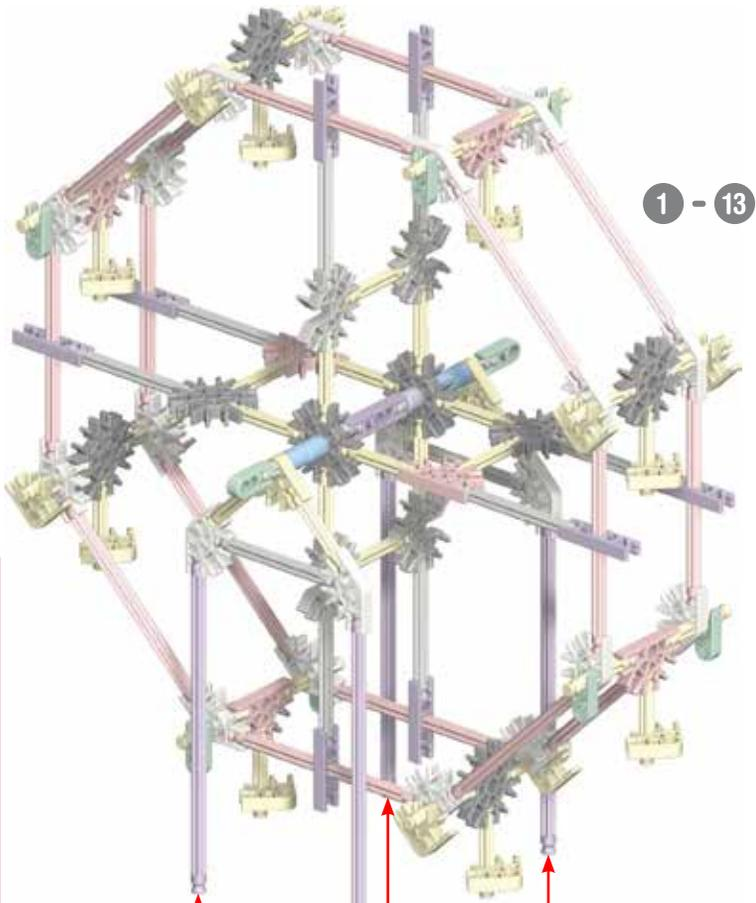
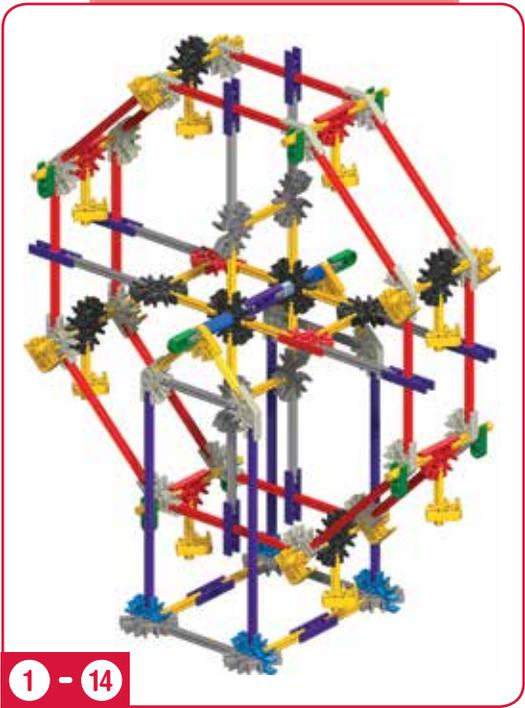
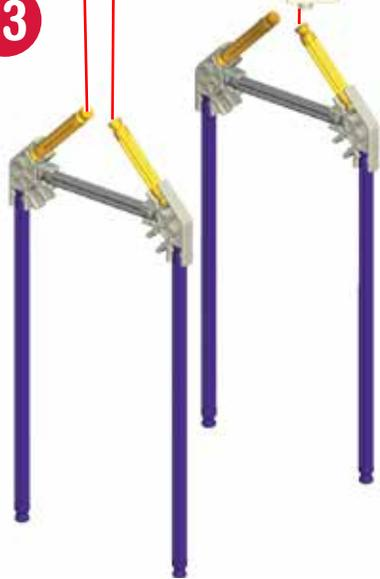

14

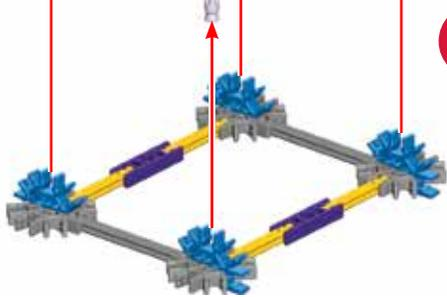

Find **25** more BUILDING IDEAS at  
[www.knex.com/instructions](http://www.knex.com/instructions)  
and enter code **12575**.

Trouver **25** plus D'IDÉES DE CONSTRUCTION  
à [www.knex.com/instructions](http://www.knex.com/instructions)  
et appuyez le code **12575**.



(ES) **Español**

(Página 2)

## Básicos de Construcción

### Empieza a construir

Cada K'NEX pieza tiene su propia forma y color. Mientras construyes, trata de colocar tu modelo en la misma dirección que se muestra en las instrucciones. Los colores desteñidos muestran que esta sección ya está construida.

### Conectores

Usted puede deslizar estos conectores especiales juntos. Empuje firmemente hasta que oiga un "clic".

### Espaciadores

Asegúrese de usar el color correcto y el número de espaciadores que se muestra en las instrucciones.

(Página 3)

### Lista de Piezas

Antes de empezar con la construcción, asegúrate de comparar las piezas en tu conjunto con la lista de las piezas aquí. Si faltan algunas, llámanos o escribenos siguiendo las instrucciones en la página trasera. Estamos aquí para ayudarte.

(Página 26)

## IDEAS DE CONSTRUCCIÓN

Para obtener instrucciones de los estos modelos vaya a [www.knex.com/instructions](http://www.knex.com/instructions) y entre en el código **12575**.

(DE) **Deutsch**

(Seite 2)

## Grundlegende Bauanleitungen für K'NEX

### Los geht's mit dem Bauen

Jedes K'NEX Teil hat seine eigene Form und Farbe. Versuche, dein Modell beim Zusammenbauen so zu orientieren, dass es in die gleiche Richtung weist, wie es in den Anleitungen beschrieben und gezeigt wird. Blasse Farben weisen darauf hin, dass dieser Streckenabschnitt bereits zusammengebaut ist.

### Verbindungsstücke

Verbindungsstücke haben besonders lange Schlitzte. Achte beim Aneinanderfügen dieser Teile darauf, dass du ein Klickgeräusch hörst.

### Abstandsstücke

Achte darauf, die richtige Farbe und Anzahl von Abstandsstücken wie in der Anleitung gezeigt zu verwenden.

### Flexi-laschen

Eine Flexi-Lasche ist eine Lasche, die du zu einer Kurve zurechtbiegen kannst. Sie lassen sich leichter an dein Modell anschließen, wenn du sie mehrmals hin- und herbiegst, um sie flexibler zu machen, bevor du sie das erste Mal benutzt.

(Seite 3)

## Teileliste

Bevor du mit dem Bauen anfängst, solltest du prüfen ob die Teile in deinem Bausatz mit denen auf dieser Teileliste übereinstimmen. Falls etwas fehlt, rufe uns an oder schreibe uns (siehe Rückseite). Wir sind für dich da!

(Seite 20, 22)

## BAUVORSCHLÄGE

Für Anweisungen dieser Modelle gehen sie zu [www.knex.com/instructions](http://www.knex.com/instructions) und geben sie Code **12575** ein.

(IT) **Italiano**

(Pagina 2)

## Istruzioni di base per costruire con K'NEX

### Comincia a costruire

Ogni K'NEX pezzo ha una sua forma e un suo colore. Cerca di tenere il modello nella stessa direzione della figura e in tal modo sarà più semplice allegare i pezzi nei posti giusti. I colori spenti ti dicono che questa sezione è già stata costruita.

### Connettori

È molto importante posizionare i connettori in una specifica direzione. Spingi con forza fino ad udire un clic.

### Spaziatori

Accertati che usate il colore corretto e il numero di spaziatori mostrati nell' istruzioni.

(Pagina 3)

### Elenco delle parti

Prima di cominciare a costruire, accertati di confrontare le parti che sono nel tuo set con l'elenco delle parti qui. Se ne manca una chiamaci o scrivici usando le informazioni che sono nella retrocopertina. Noi siamo qui per aiutarvi!

### Aste flessibili

Un'asta flessibile può essere piegata per fare le curve. Sarà più facile attaccarla al modello se prima la pieghi per alcune volte.

(Pagina 26)

## IDEE DI COSTRUZIONE

Per istruzioni di questi modelli vai a [www.knex.com/instructions](http://www.knex.com/instructions) inserire il codice **12575**.

(PT) **Português**

(Página 2)

## Pontos básicos para a construção K'NEX

### Inicia a construção

Cada K'NEX peça tem a sua própria forma definida e cor. Enquanto estás a montar as peças, tenta manter o teu modelo na mesma direcção, conforme mostrado na ilustração, para assim conectar as peças correctamente. As cores desbotadas indicam que esta secção já está construído.

## Conectores

Empurre estes conectores especiais juntos firmemente até ouvir um "clic".

## Espaçadores

Existirão certos pontos no teu modelo que necessitam a colocação de espaçadores. Certifique-se de contar com cuidado.

(Página 3)

## Lista de peças

Antes de iniciares a construção, certifica-te de que comparas as peças do teu conjunto com a lista das peças aqui. Se está desaparecido uma peça telefona ou escreve-nos usando as informações indicadas na contracapa. Estamos aqui para te ajudar!

## Varetas flexíveis

Uma vareta flexível é uma vareta que podes dobrar para formar curvas. Para montares no teu modelo, será mais fácil se dobrares primeiro a vareta para trás e para a frente.

(Página 26)

## IDEIAS DE CONSTRUÇÃO

Para obter instruções destes modelos vá em [www.knex.com/instructions](http://www.knex.com/instructions) e digite o código **12575**.

(NL) **Nederlands**

(Bladzijde 2)

## Basisstappen voor K'NEX bouwen

### Begin te bouwen

Elk K'NEX stuk heeft zijn eigen vorm en kleur. Tracht je model in dezelfde richting te plaatsen als de aanwijzingen terwijl je bouwt en monteert. De vervaagde kleuren duiden aan dat dit deel reeds is opgebouwd.

### Verbindingsstukken

Duw deze speciale verbindingstukken stevig tegen elkaar aan tot je een 'klik' hoort.

### Afstandhouders

Zorg dat je het juiste en kleur aantal afstandhouders gebruikt.

(Bladzijde 3)

### Lijst met onderdelen

Zorg ervoor dat de onderdelen te vergelijken met de onderdelen hier op te sommen. Als er iets is ontbreekt, bel of schrijf ons gebruik van de informatie op de achterkant. Wij zijn hier om u te helpen!

## Flexi-rods

Een Flexi-rod is een stang die kan gebogen worden om bochten of curves te maken. Ze maken zich gemakkelijker vast aan je model wanneer je ze eerst een paar keer heen en weer buigt.

(Bladzijde 26)

## BOUWIDEËN

Voor instructies van deze modellen naar [www.knex.com/instructions](http://www.knex.com/instructions) en vul de code **12575**.



**SUPER VALUE TUB**  
Building Set

**MEGA BOX**  
Jeu de construction

**knex.com**

facebook.com/knex

@knexbrands



©2017 K'NEX Limited Partnership Group, P.O. Box 700, Hatfield, PA 19440-0700; 1-800-KID-KNEX (USA/ Canada/ États-Unis/EE.UU.); email@knex.com; knex.com. K'NEX UK Ltd, 200 Brook Drive, Green Park, Reading, RG6 2UB England; K'NEX France, 24 rue du Quatre Septembre, 75002 Paris, France. For customers outside the USA/Canada please contact your local distributor at [www.knex.com/distributors](http://www.knex.com/distributors).

(FR) Pour les clients en dehors du Canada et des États-Unis, veuillez contacter votre distributeur local que vous pouvez trouver sur [www.knex.com/distributors](http://www.knex.com/distributors).

(ES) El cliente que no vive en EE.UU./Canadá se pone en contacto con el distribuidor local. Encuentre la información para el distribuidor local en [www.knex.com/distributors](http://www.knex.com/distributors).

(EN) K'NEX is a registered trademark and Imagine is a trademark of K'NEX Limited Partnership Group.  
(FR) K'NEX est une marque déposée et Imagine est une marque de K'NEX Limited Partnership Group.  
(ES) K'NEX es una marca registrada y Imagine es una marca de K'NEX Limited Partnership Group.

(EN) Product & colors may vary. Most models can be built one at a time.

(FR) Le produit et ses couleurs peuvent varier. Les différents modèles ne peuvent être construits qu'un par un.

(ES) El producto y los colores pueden variar. La mayoría de los modelos se pueden construir uno a la vez.

(DE) Produkte und Farben können abweichen. Die meisten Modelle können immer nur einzeln gebaut werden.

(IT) Prodotti e colori possono differire. La maggior parte dei modelli si può costruire autonomamente. Istruzioni accluse.

(PT) O produto e as cores podem variar. A maioria dos modelos pode ser montado um de cada vez.

(NL) Product en kleuren kunnen variëren. De meeste modellen kunnen uitsluitend een voor een worden gebouwd.

**\*\*Sold separately**

Vendus séparément

Se venden por separado

Separat erhältlich

Venduti separatamente

Vendidos separadamente

Afzonderlijk verkrijgbaar