

7+

12423

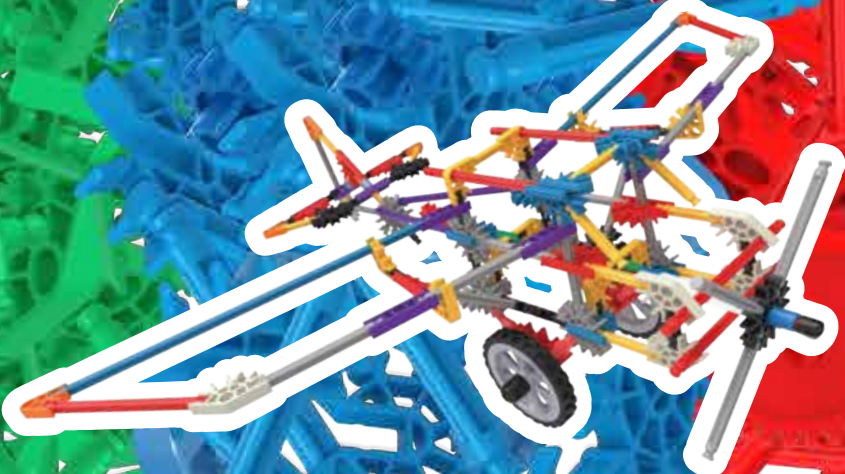

**TRAINS, PLANES  
AND AUTOMOBILES**  
**TRAINS, AVIONS  
ET AUTOMOBILES**  
**TRENES, AVIONES  
Y AUTOMOVILES**

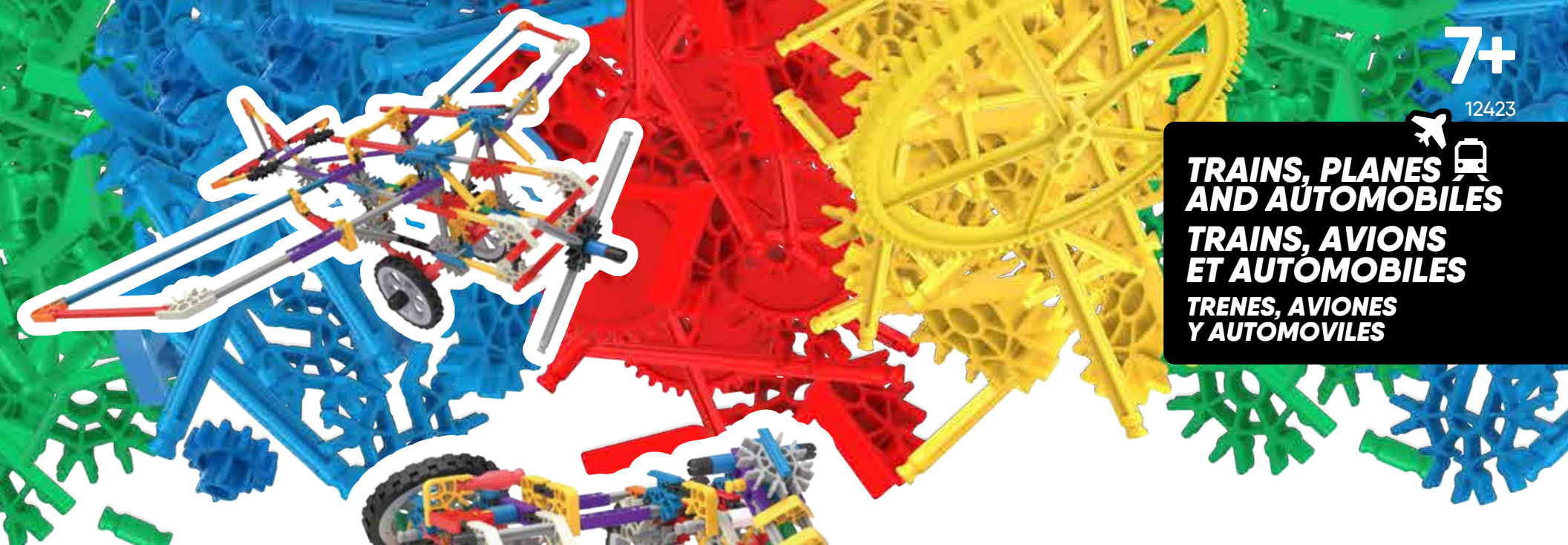

# K'nex®

BUILDING SET  
JEU DE CONSTRUCTION  
CONJUNTO DE CONSTRUCCIÓN

# 408 | 55

PIECES/PIÈCES  
PIEZAS

BUILDS/CONSTRUIT  
CONSTRUYE



## CONTENTS

|                               |                          |
|-------------------------------|--------------------------|
| Moose/Snowboarder .....4      | Eggbeater .....10        |
| Tow Truck/Ice Cream .....5    | Stealth Jet .....12      |
| Butterfly/Weightlifter .....6 | Dragster .....14         |
| Submarine .....7              | Vintage Roadster .....17 |
| Hammerhead Shark .....8       | Dump Truck .....20       |
| Swing Ride .....9             | Building Ideas .....23   |

# K'nex Building Basics

## Start Building

To begin your model, find the **1** and follow the numbers. Just look at the pictures, find the pieces in your set that match and then connect them together. Try to face your model in the same direction as the instructions while you build. The arrows show you where the parts connect, but not all connections points have arrows. Faded colors show you this section is already built.

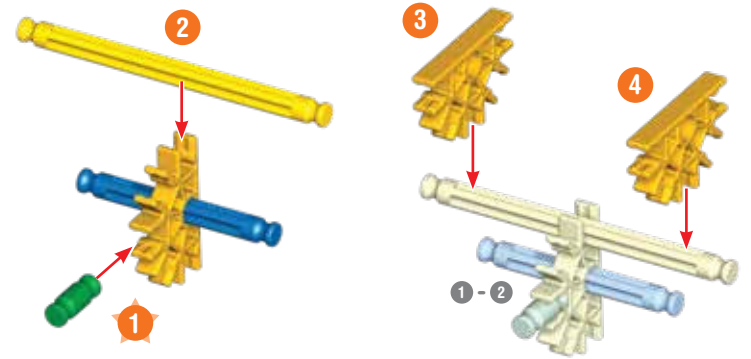

## Spacers

There are places in your model where you need to use spacers. Be sure to use the correct number of spacers shown in the instructions.



## Connectors

You can slide these special connectors together. Push tightly until you hear a "click". Pay close attention to the instructions and position them horizontally or vertically exactly as they are shown.

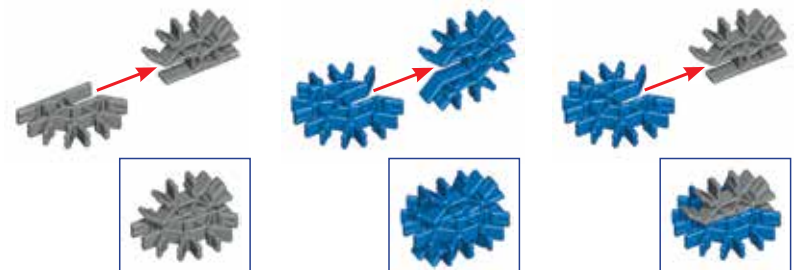

## AMERICAN MADE PARTS

### Parts List

Before you start building, be sure to compare the parts in your set with the parts list here. If anything is missing, please visit [www.Basicfun.com](http://www.Basicfun.com) to contact us. We are here to help you!

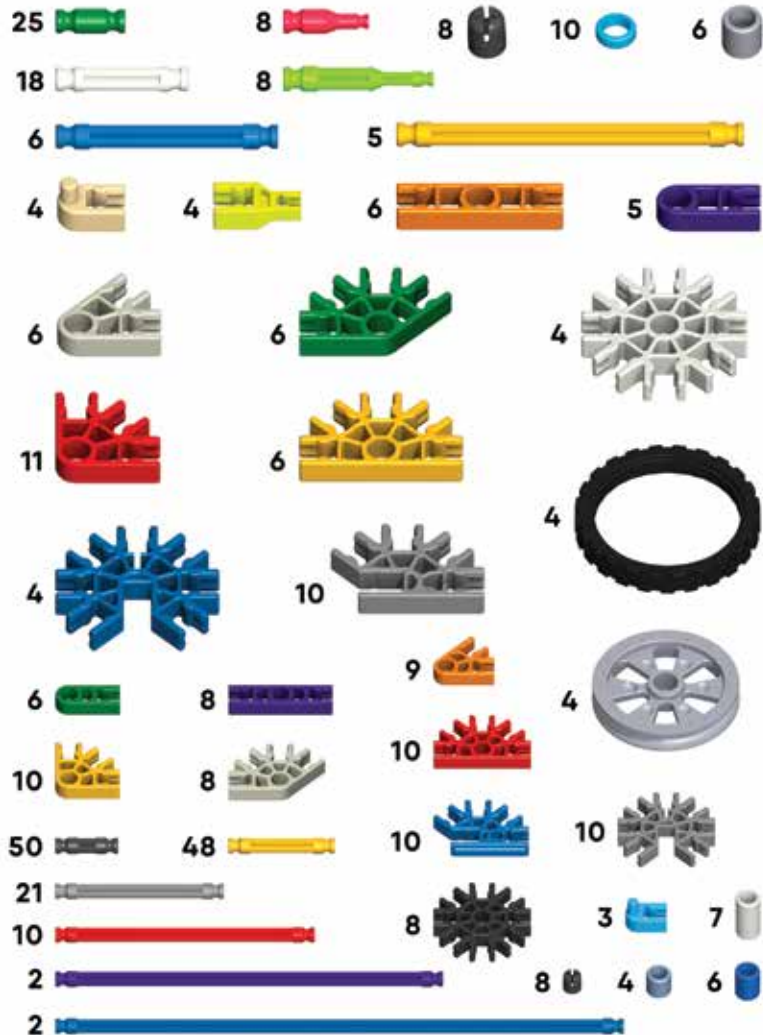

## CONTENUS

|                              |                              |
|------------------------------|------------------------------|
| Élan/Snowboarder .....4      | Fouet à oeufs..... 10        |
| Dépanneuse/Crème Glacée...5  | Avion Furtif..... 12         |
| Papillon/Haltérophile .....6 | Dragster ..... 14            |
| Sous-marin .....7            | Roadster Vintage..... 17     |
| Requin Marteau .....8        | Camion-vidage .....20        |
| Se Balancer Monter .....9    | Idée de Construction .....23 |

### FAIT AUX ÉTATS-UNIS

### Liste des pièces

Avant de commencer, s'assurer de comparer les pièces dans la boîte à la liste de pièces fournie ici. Si quelque chose manque, veuillez visiter [www.Basicfun.com](http://www.Basicfun.com) pour nous contacter. Nous sommes là pour vous aider !



# Esenciales de construcción K'NEX

## Démarrer la construction

Pour commencer le modèle, trouver l'étape numéro 1 trouver les numéros. Regarder les illustrations, trouve les pièces qui correspondent à l'illustration et les assembler. Pour vous faciliter la tâche, orienter le modèle dans le même sens que les instructions. Les flèches indiquent où les pièces s'assemblent, mais les points de raccordement n'ont pas tous des flèches. Les pièces de couleur délavées sont celles déjà assemblées.

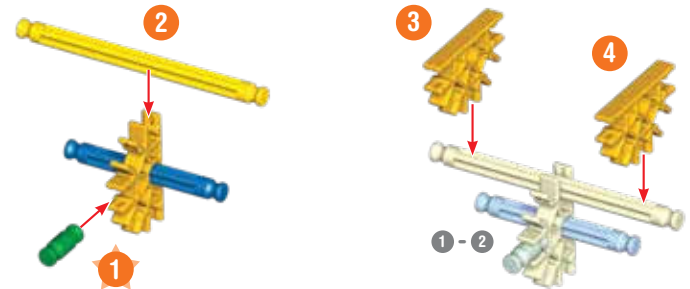

## Espaceurs

Il y a des endroits sur le modèle où des espaceurs sont nécessaires. S'assurer d'utiliser la bonne couleur et le nombre d'espaceurs indiqué sur les instructions.



## Connecteurs

Vous pouvez assembler ces connecteurs tout à fait uniques en les faisant glisser l'un dans l'autre. Pousser fort jusqu'au « clic ». Lire les instructions attentivement et les positionner horizontalement ou verticalement, en suivant exactement les illustrations.

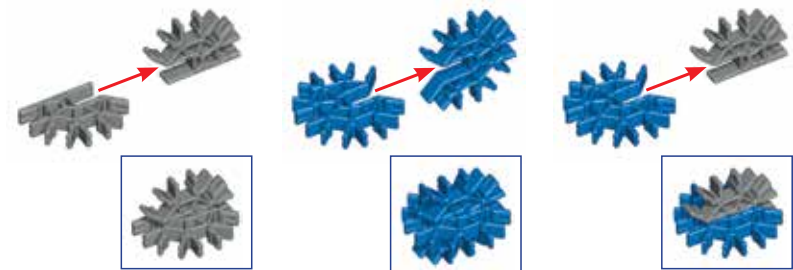

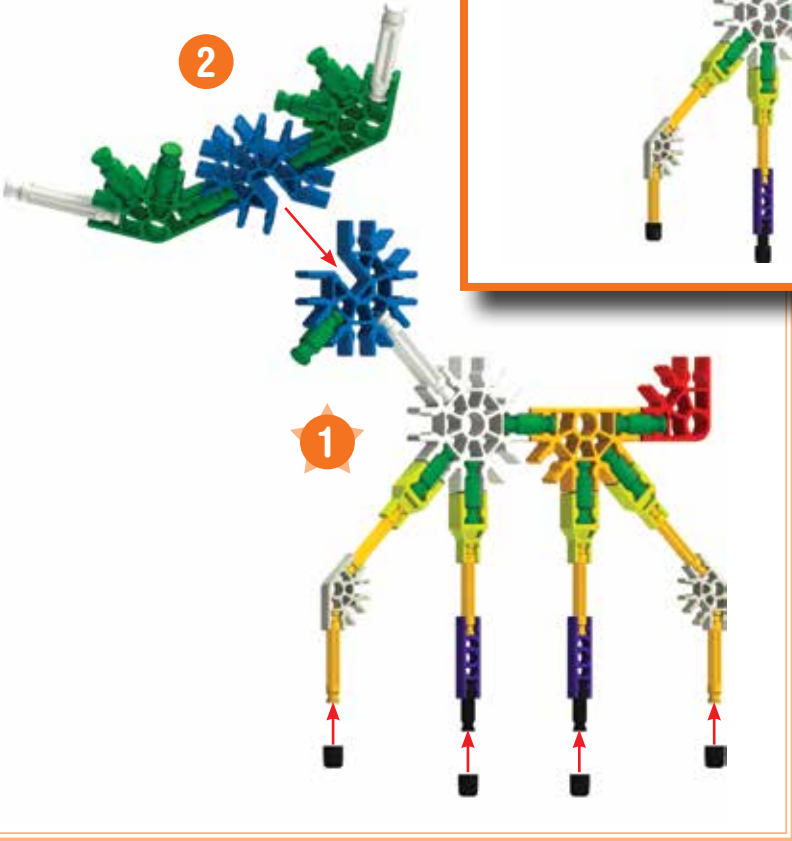

**!** **WARNING:** CHOKING HAZARD – Small parts. Not for children under 3 years.  
**ATTENTION :** RISQUE D'ÉTOUFFEMENT – Pièces de petite taille. Ne convient pas aux enfants de moins de 3 ans.  
**ADVERTENCIA:** PELIGRO DE ASFIXIA – Piezas pequeñas. No para niños menores de 3 años.  
**WARNHINWEIS:** ERSTICKUNGSGEFAHR – Kleinteile. Nicht geeignet für Kinder unter 3 Jahren.  
**AVVERTENZA:** PERICOLO DI SOFFOCAMENTO – Contiene piccole parti. Non adatto per bambini al di sotto di 3 anni.  
**AVISO:** PERIGO DE SUFOCAÇÃO – Peças pequenas. Não se destina a crianças com menos de 3 anos de idade.  
**WAARSCHUWING:** VERSTIKKINGSGEVAAR – Kleine onderdelen. Niet geschikt voor kinderen onder 3.

**CAUTION:** Keep hands, face, hair and clothing away from all moving parts.  
**ATTENTION :** Garde les cheveux, les doigts, la figure et les vêtements à l'écart de toutes les pièces mobiles.  
**PRECAUCIÓN:** Mantén el cabello, los dedos, la cara y la ropa alejada de las piezas móviles.  
**VORSICHT:** Haare, Finger, Gesicht und Kleidungsstücke nicht mit beweglichen Teilen in Berührung kommen lassen.  
**ATTENZIONE:** Tenere i capelli, le dita, il viso e i vestiti lontano da tutte le parti in movimento.  
**CUIDADO:** Mantém o cabelo, os dedos, a cara e a roupa afastados de todas as peças móveis.  
**OPGEPAST:** Hou het haar, de vingers, het gezicht en kledij verwijderd van alle bewegende onderdelen.

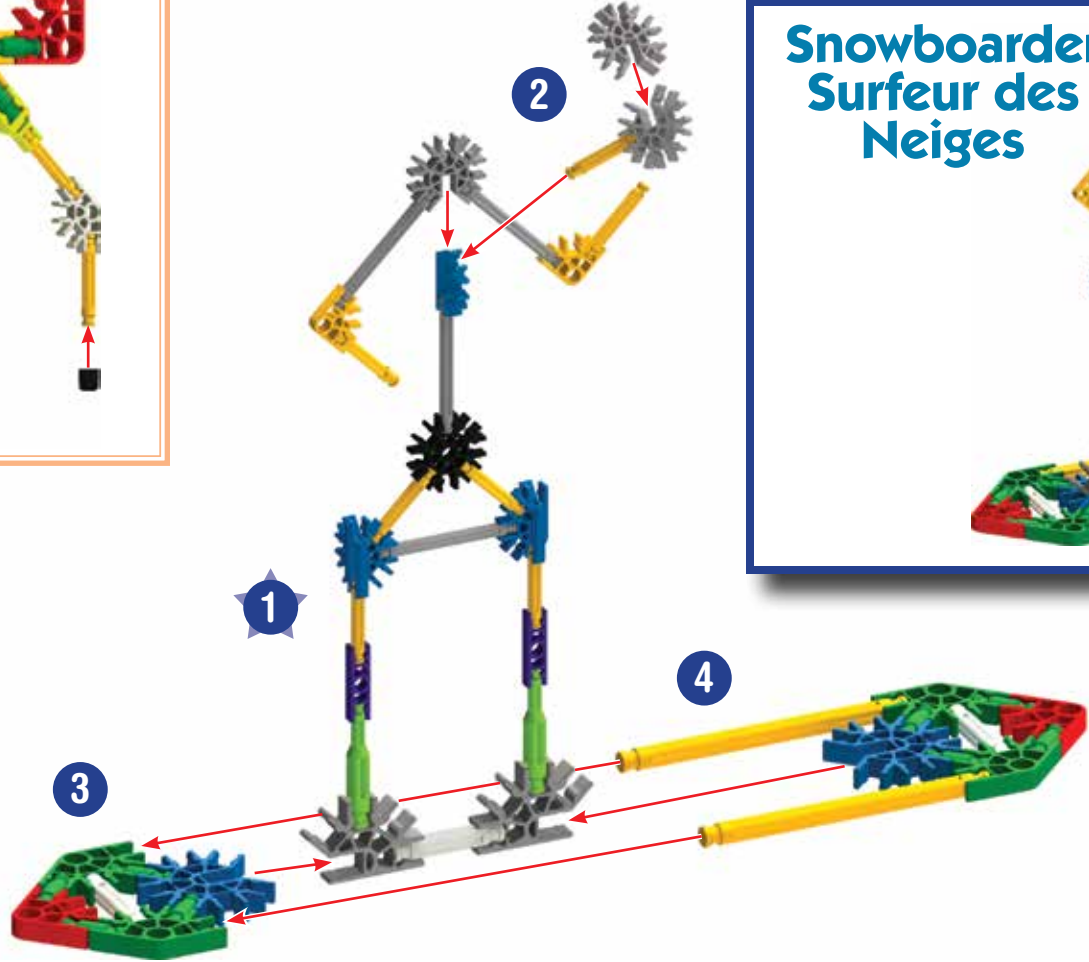

## Tow Truck Dépanneuse

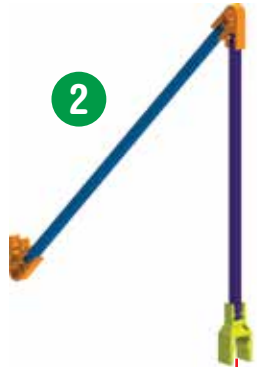

2

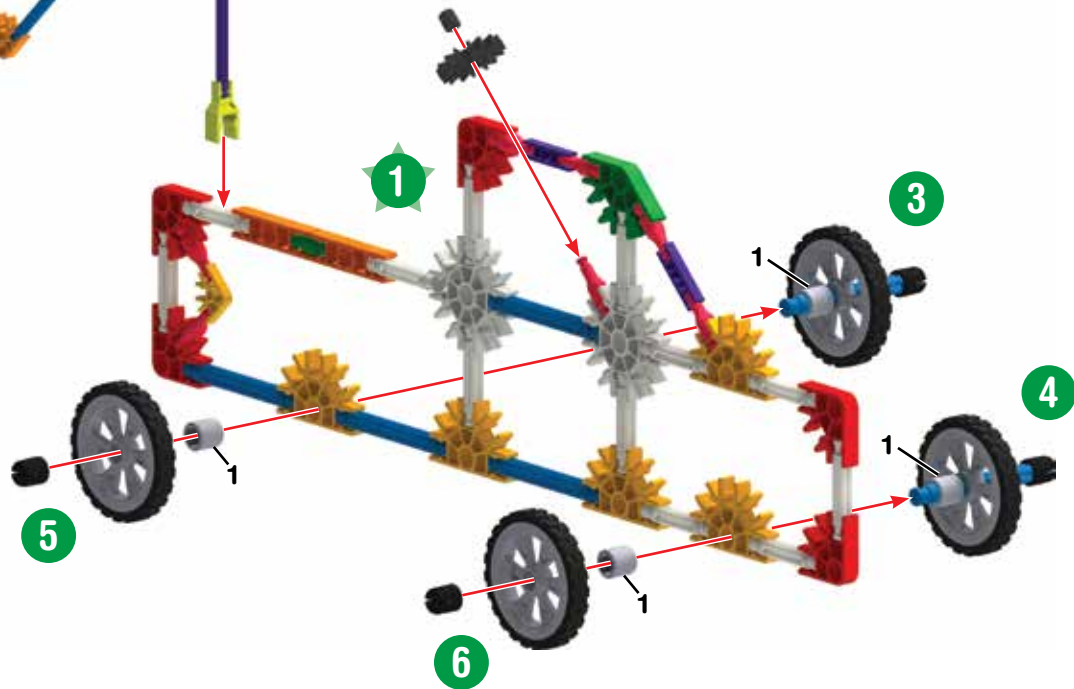

1

3

4

5

6

1

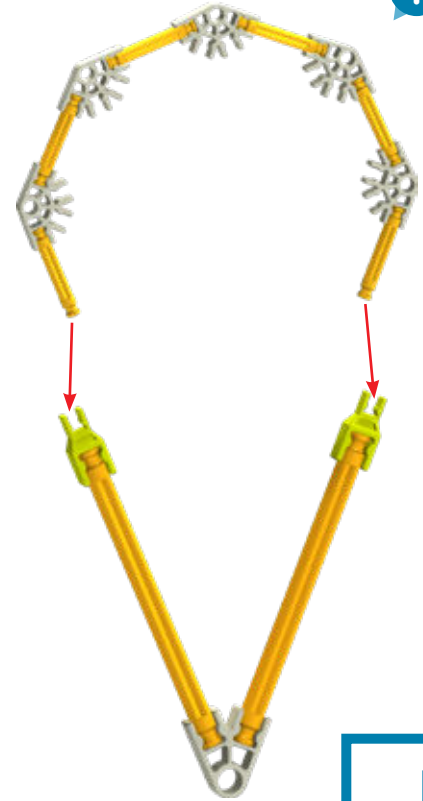

## Ice Cream Glace



# Butterfly Papillon

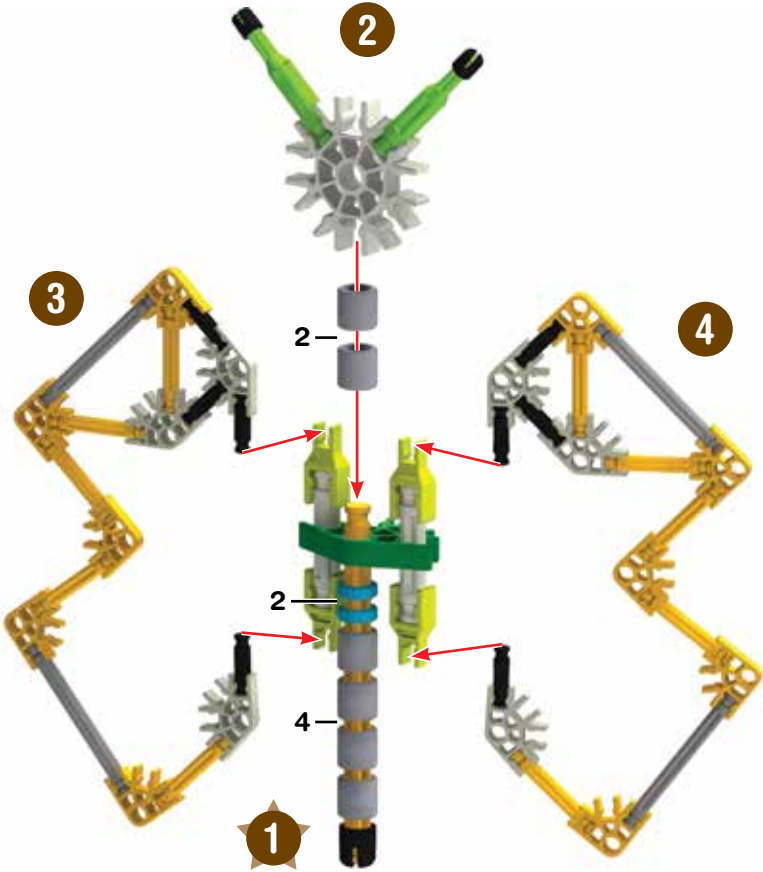

# Weightlifter Haltérophile

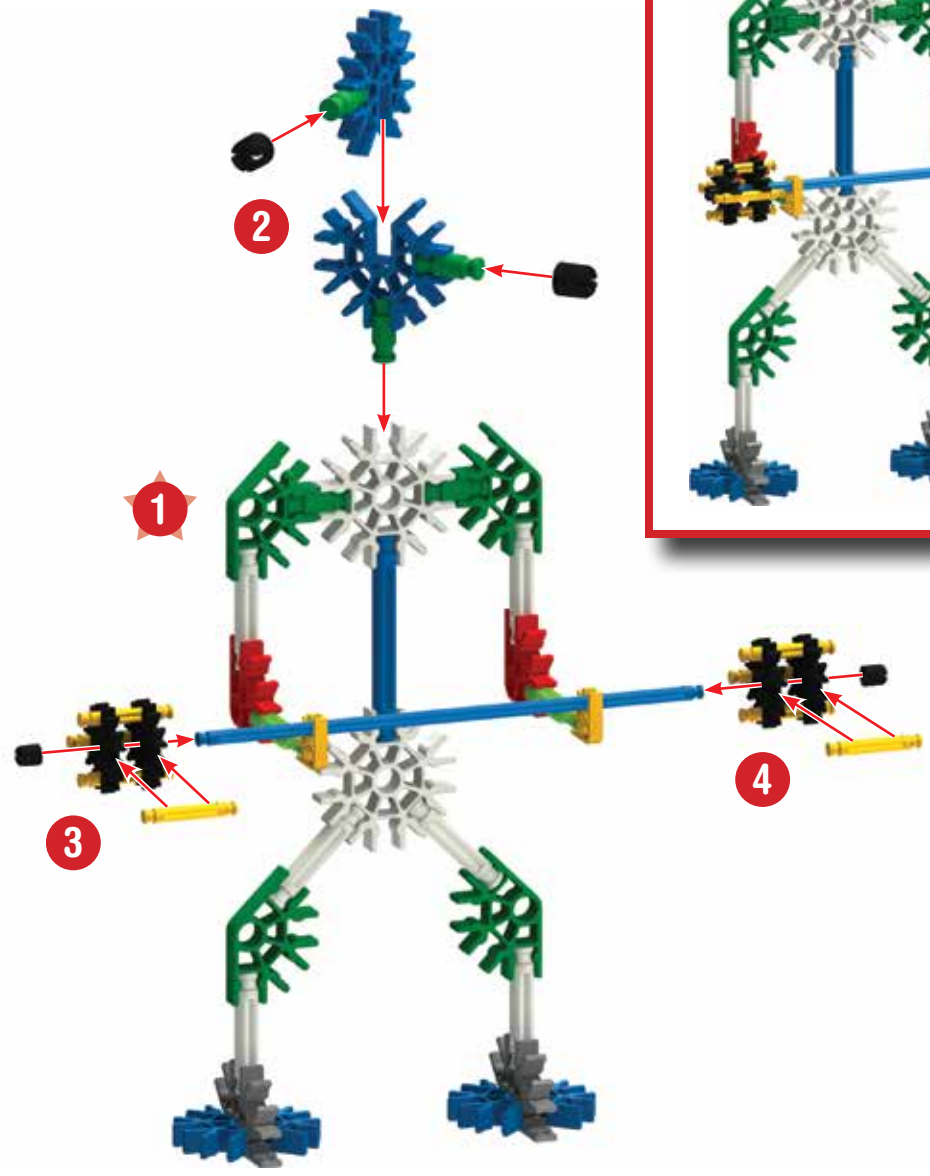

# Submarine Sous-marin

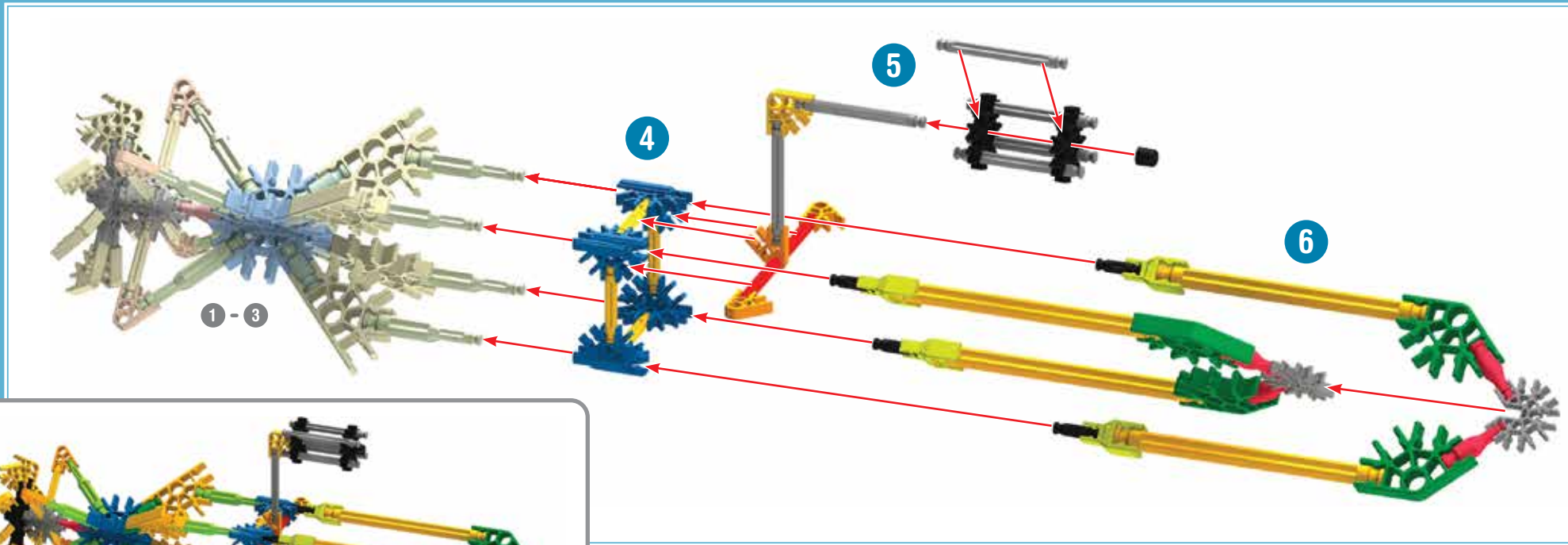
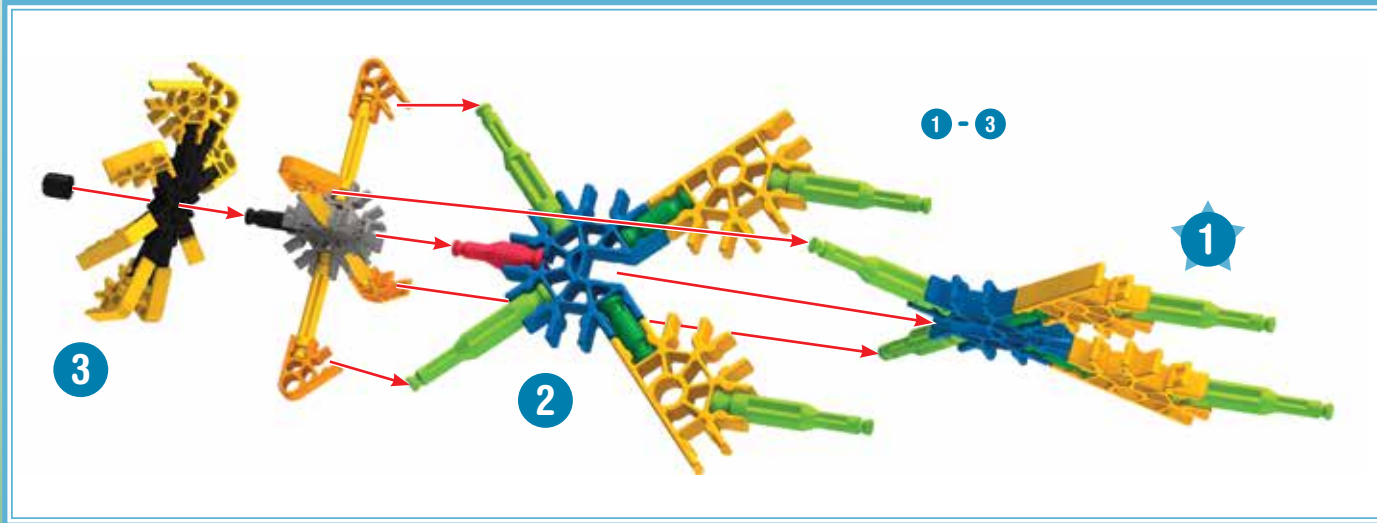

# Hammerhead Shark Requin Marteau

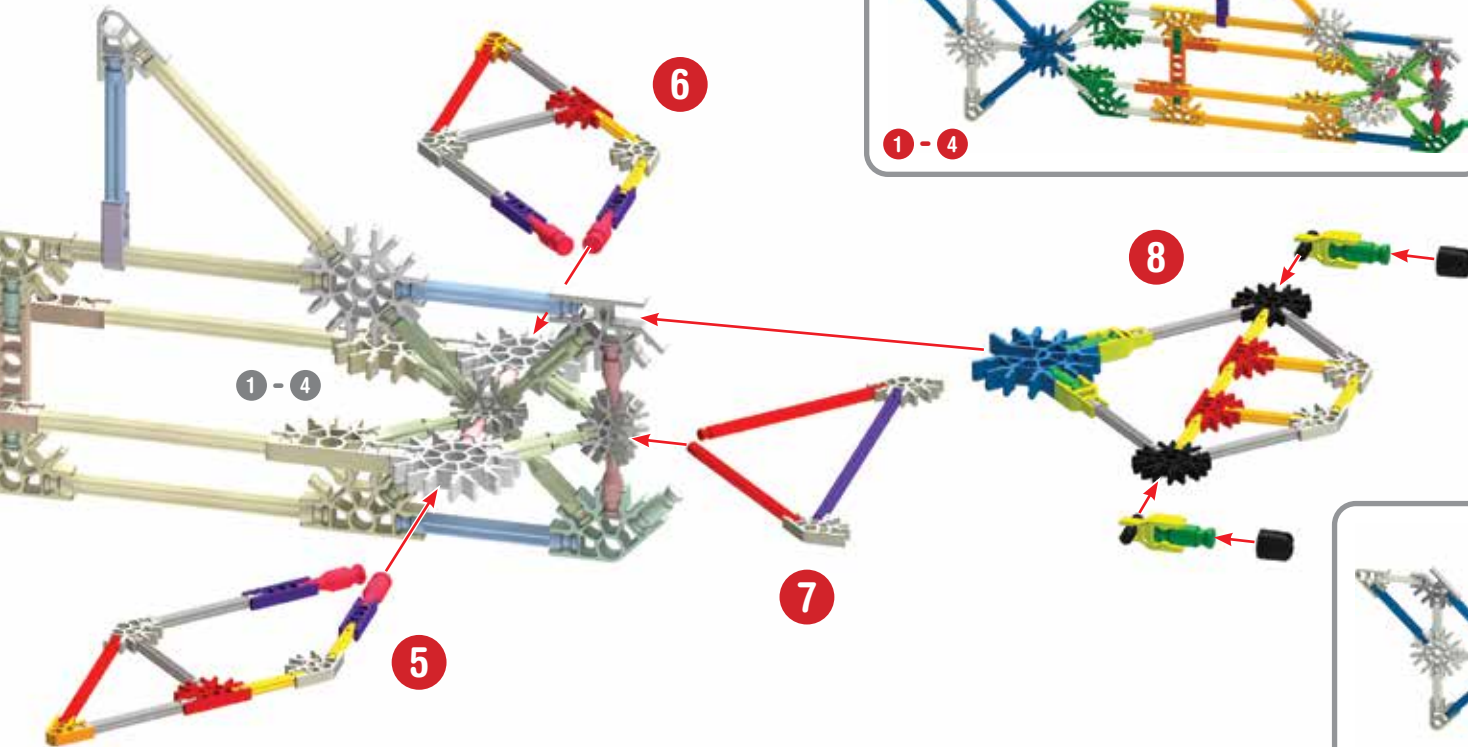
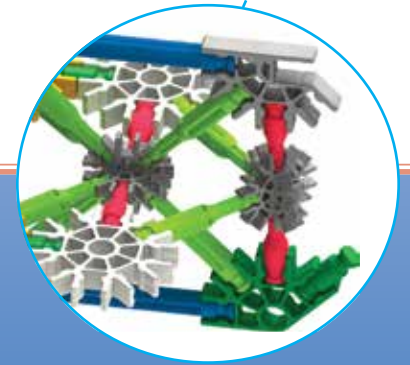
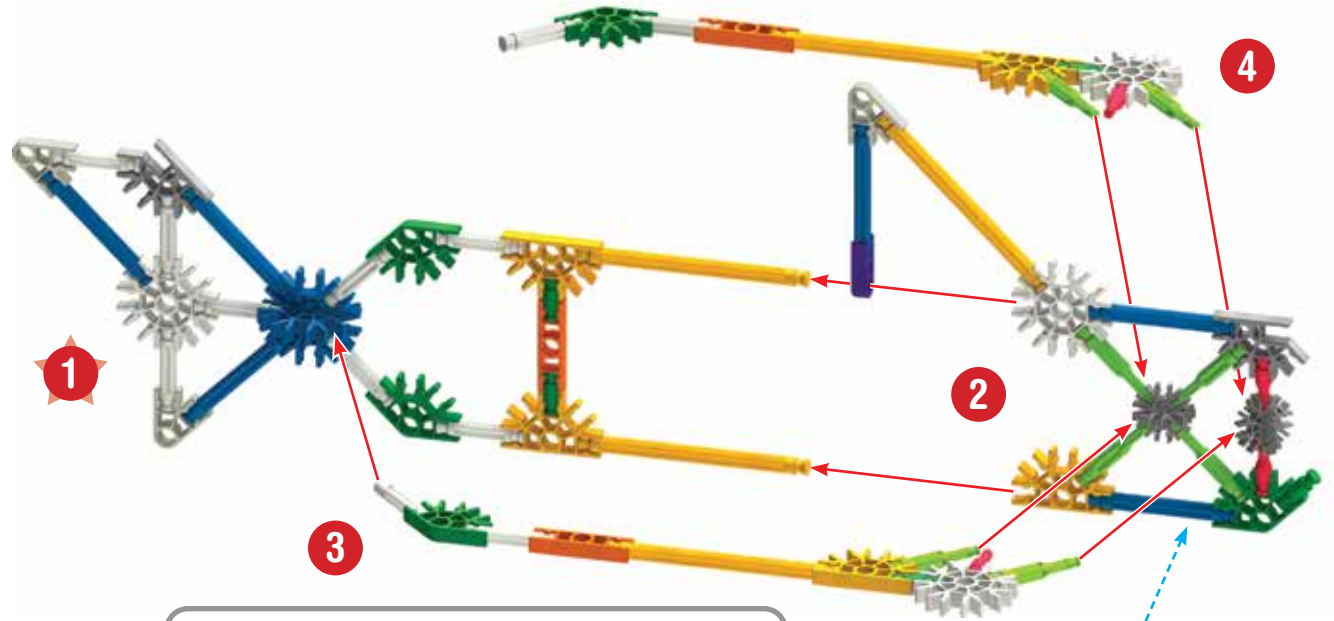



# Swing Ride Se Balancer Monter

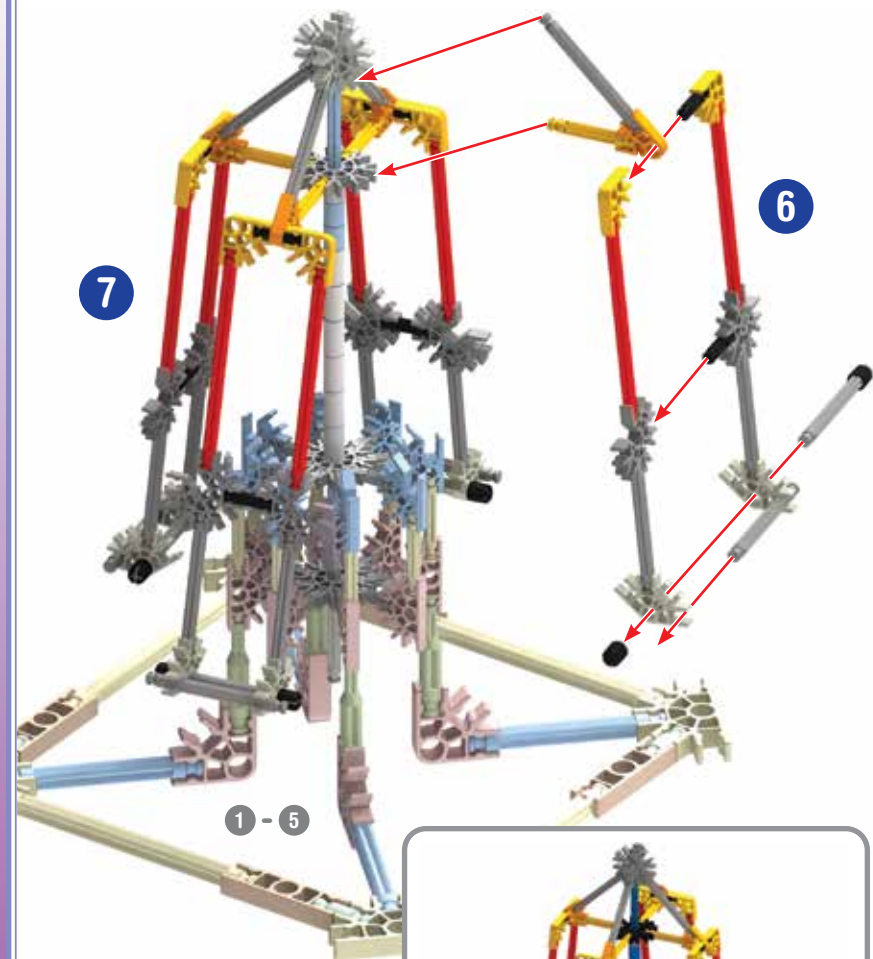
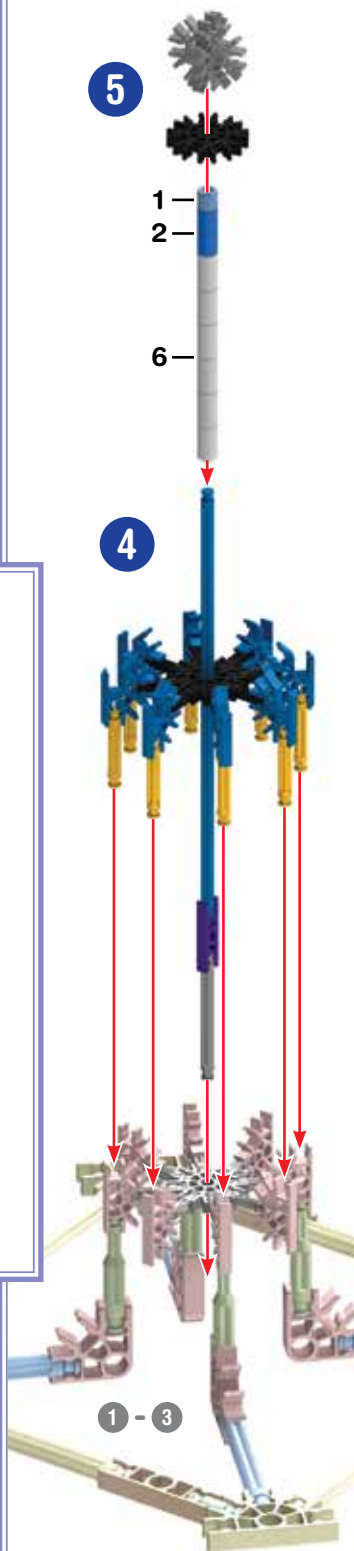
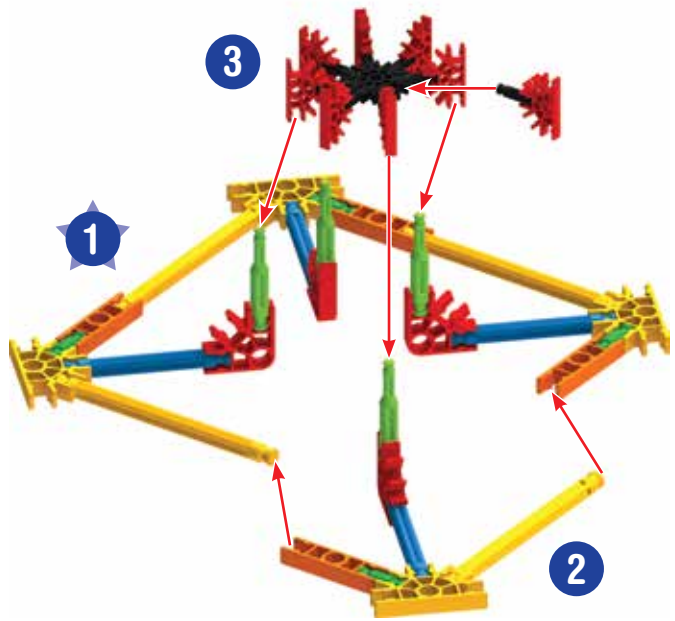

# Eggbeater Fouet à oeufs

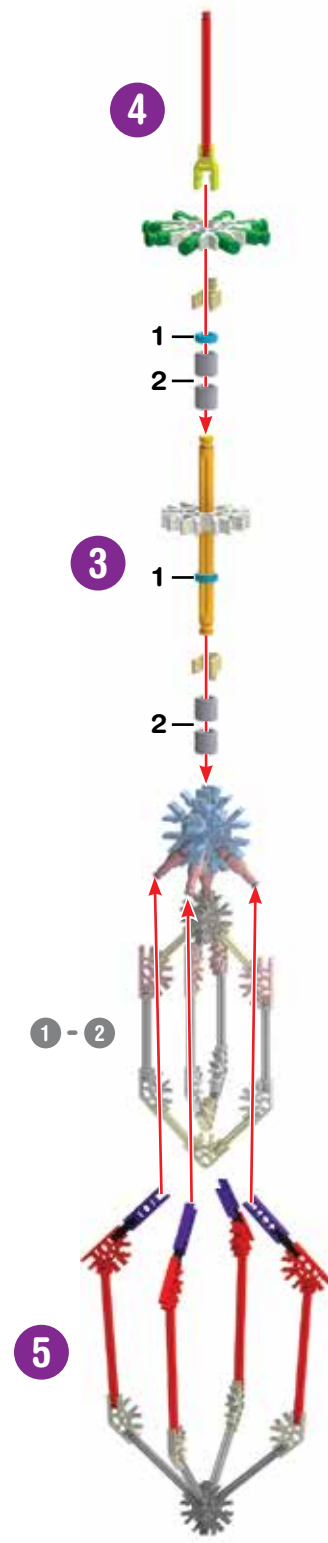
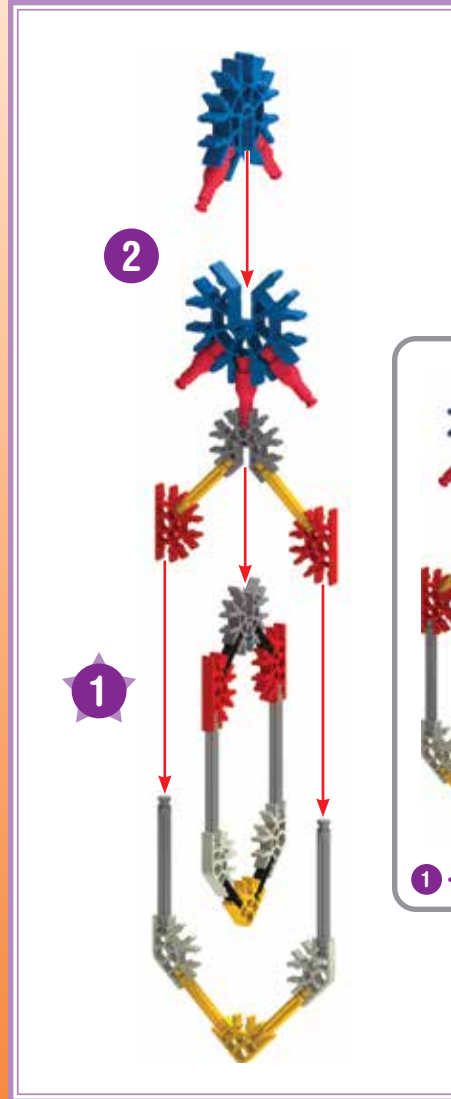

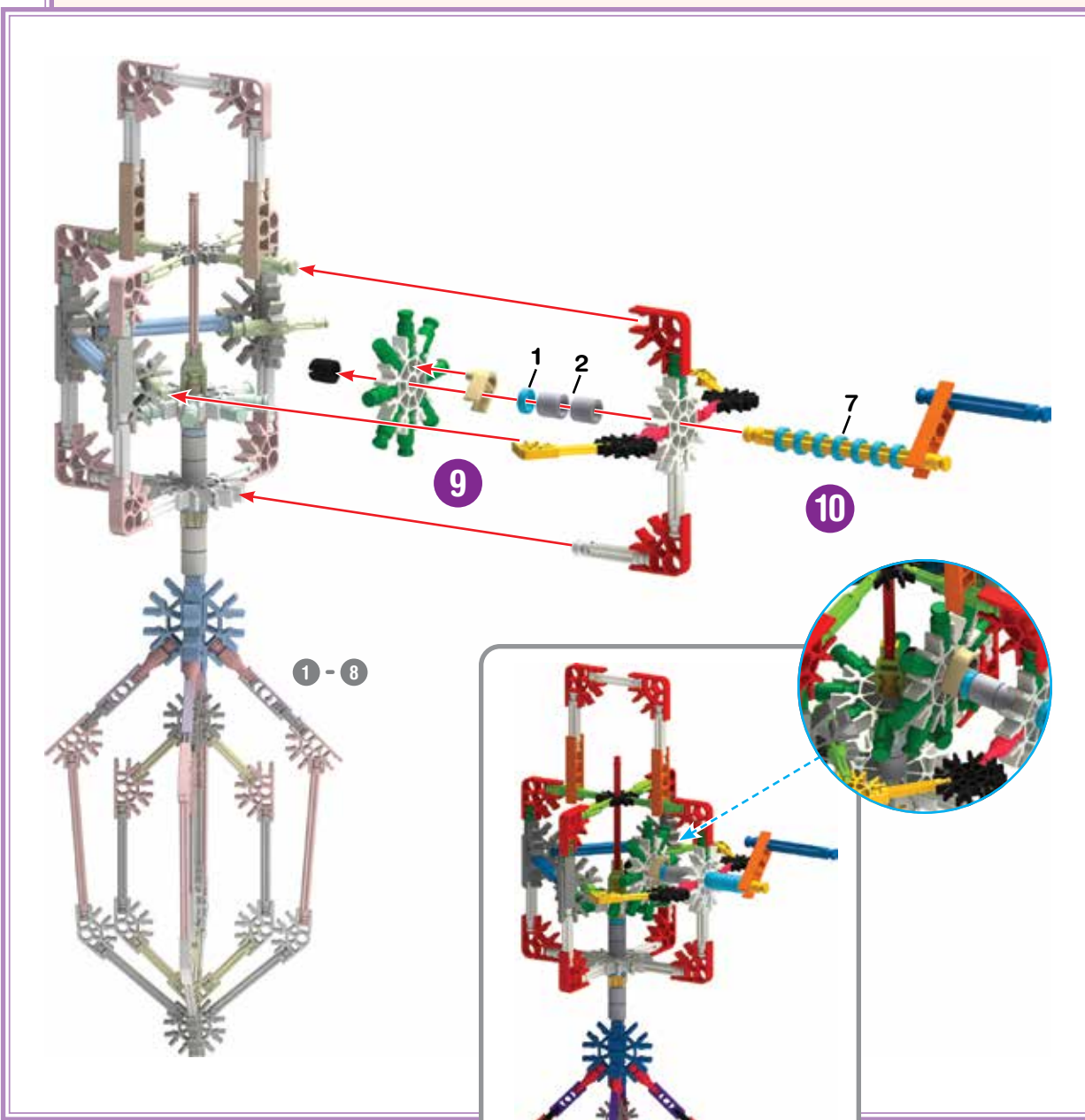
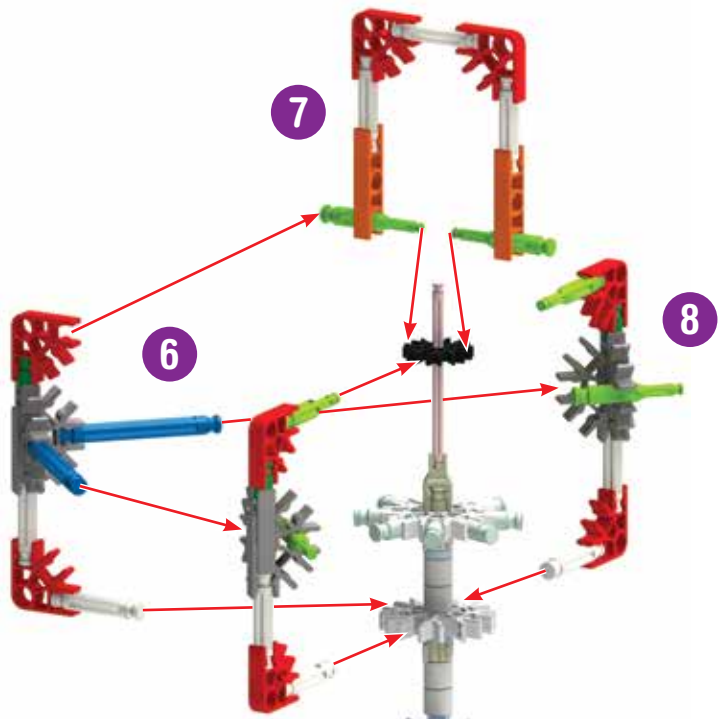

# Stealth Jet Avion Furtif

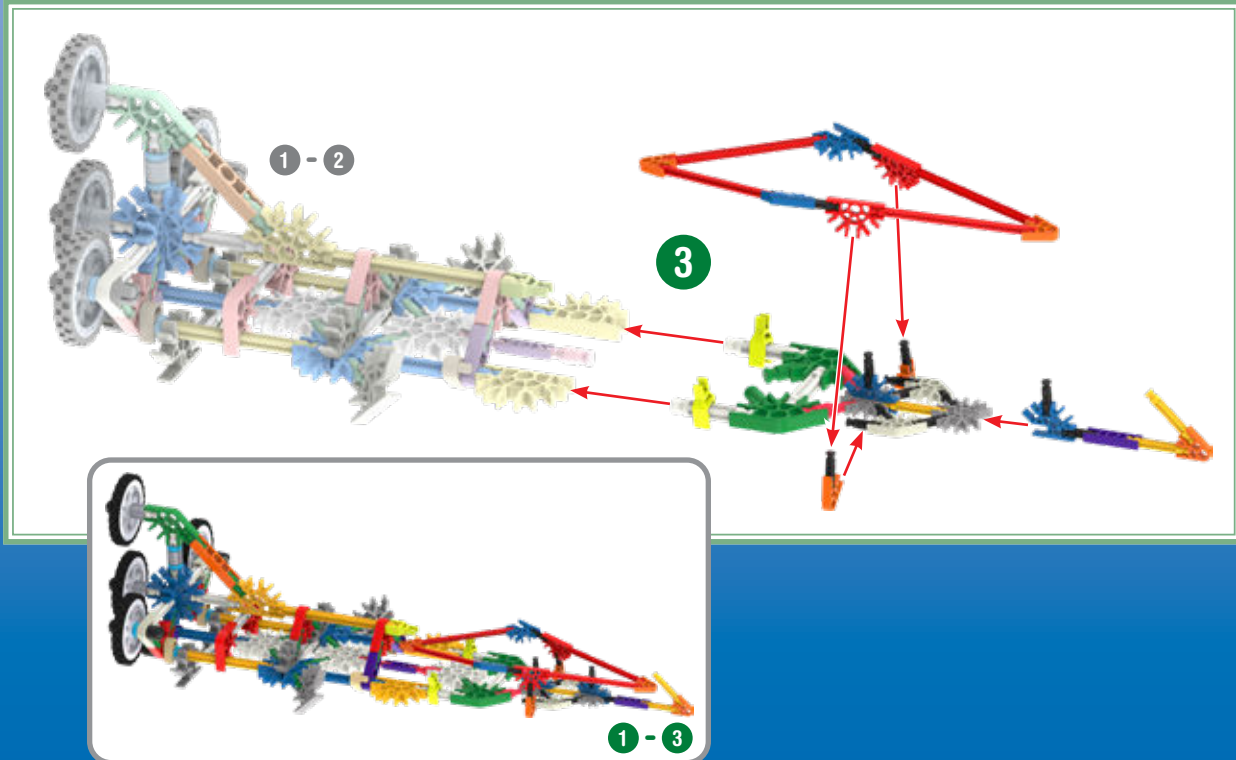
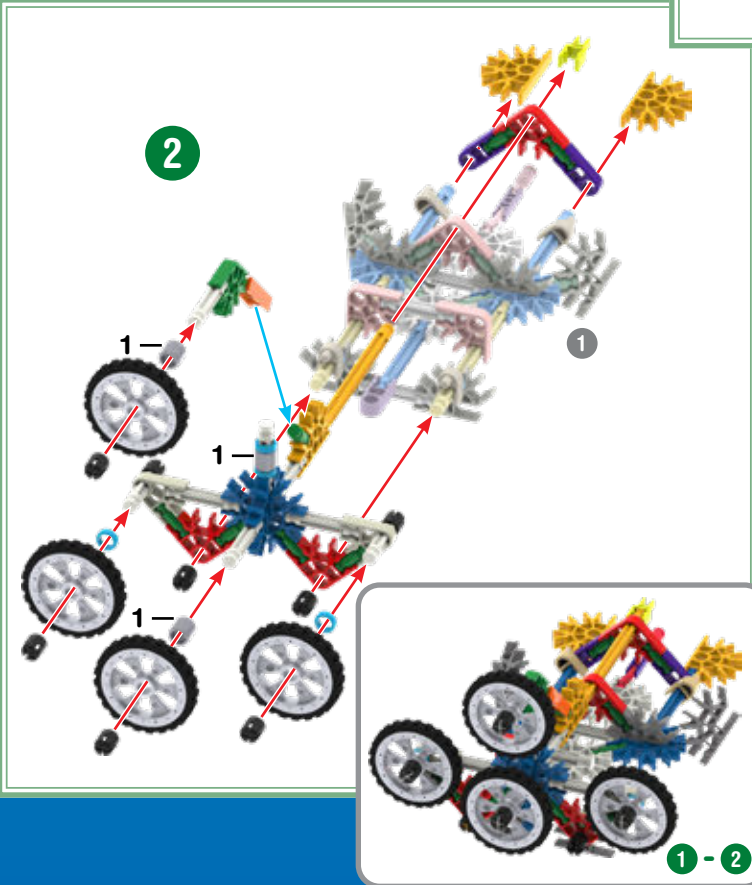
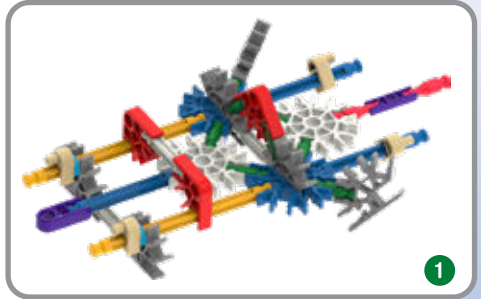
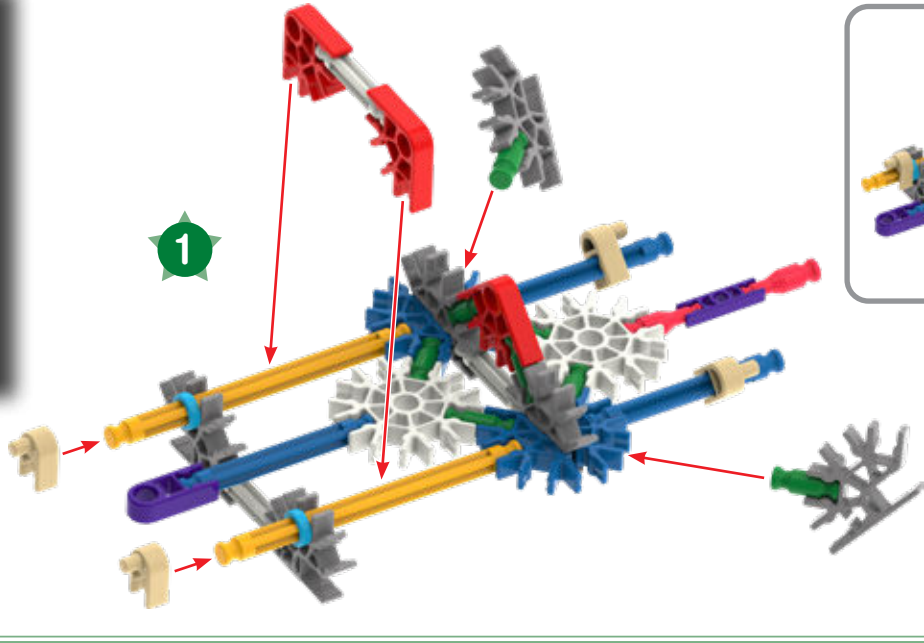

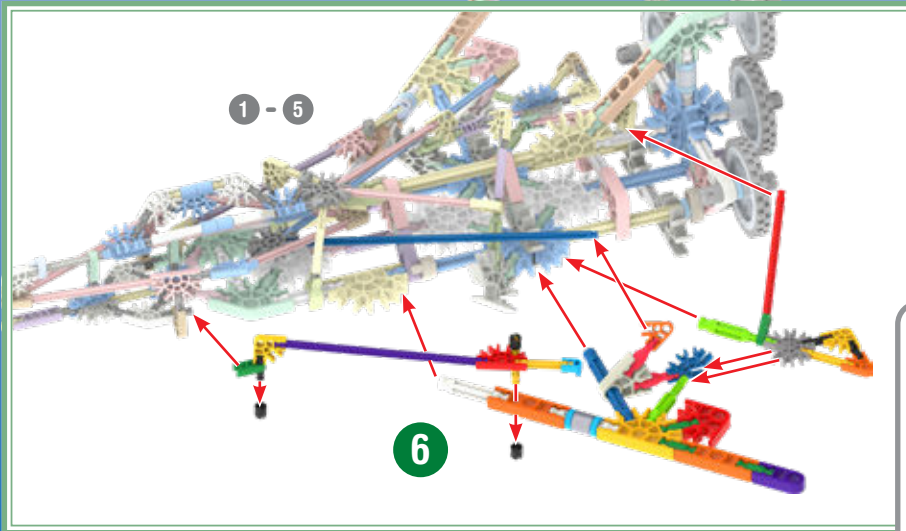
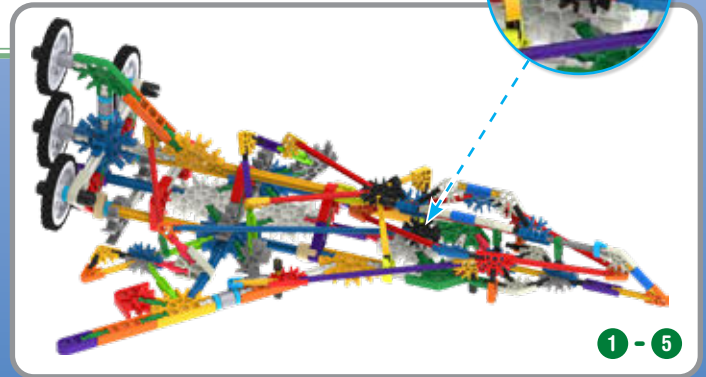
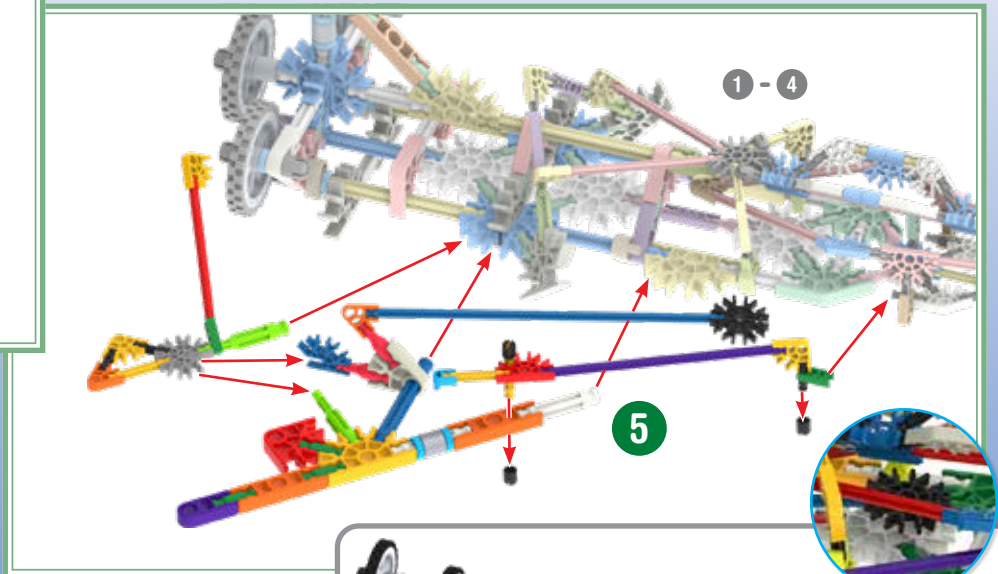
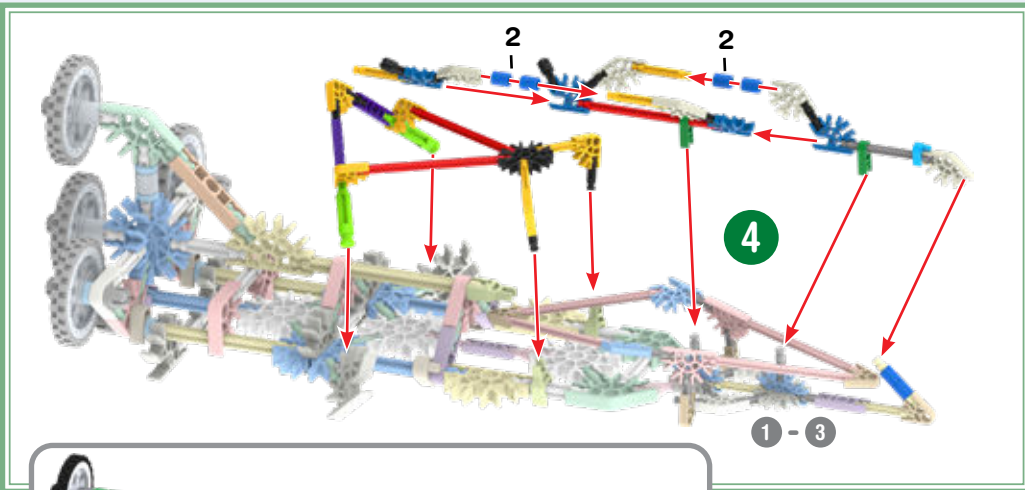

# Dragster Dragster

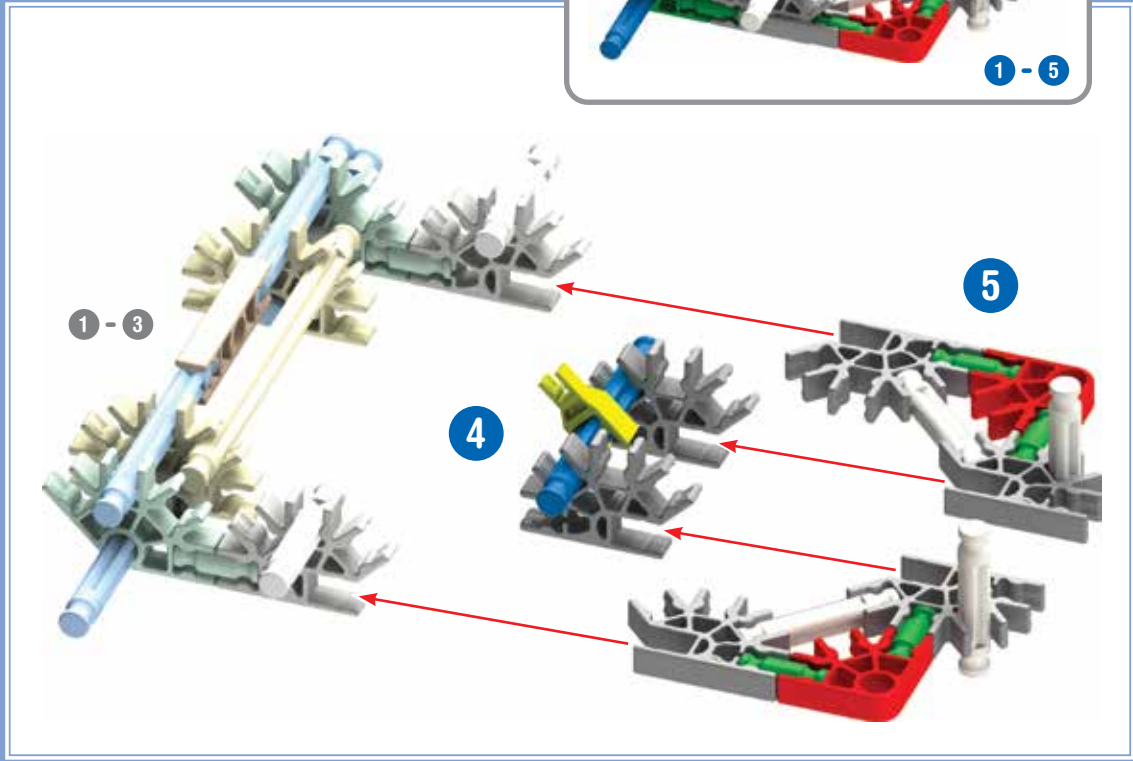
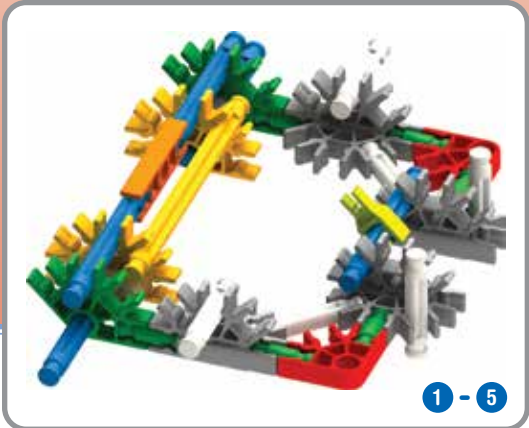
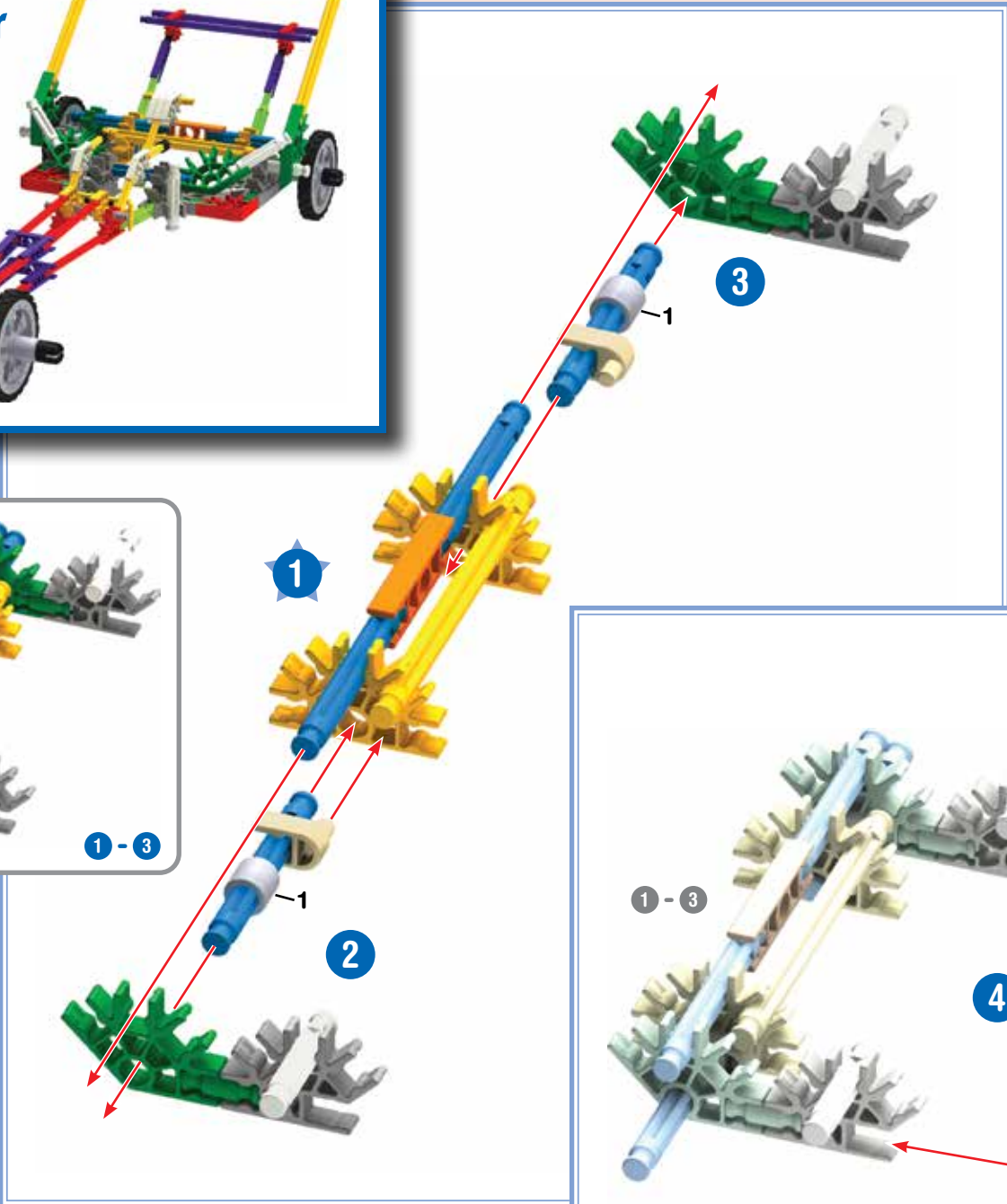

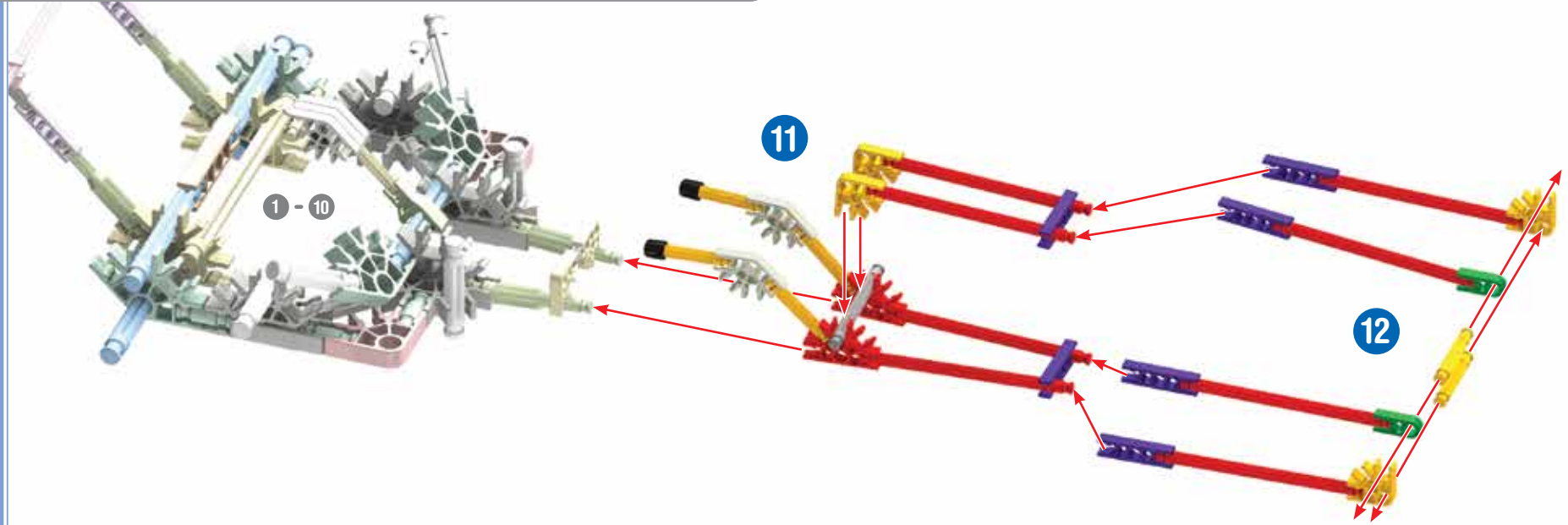
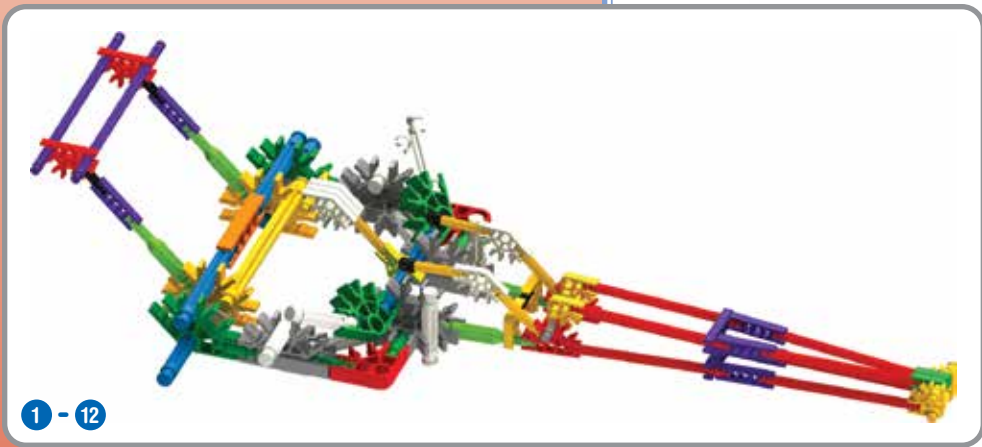
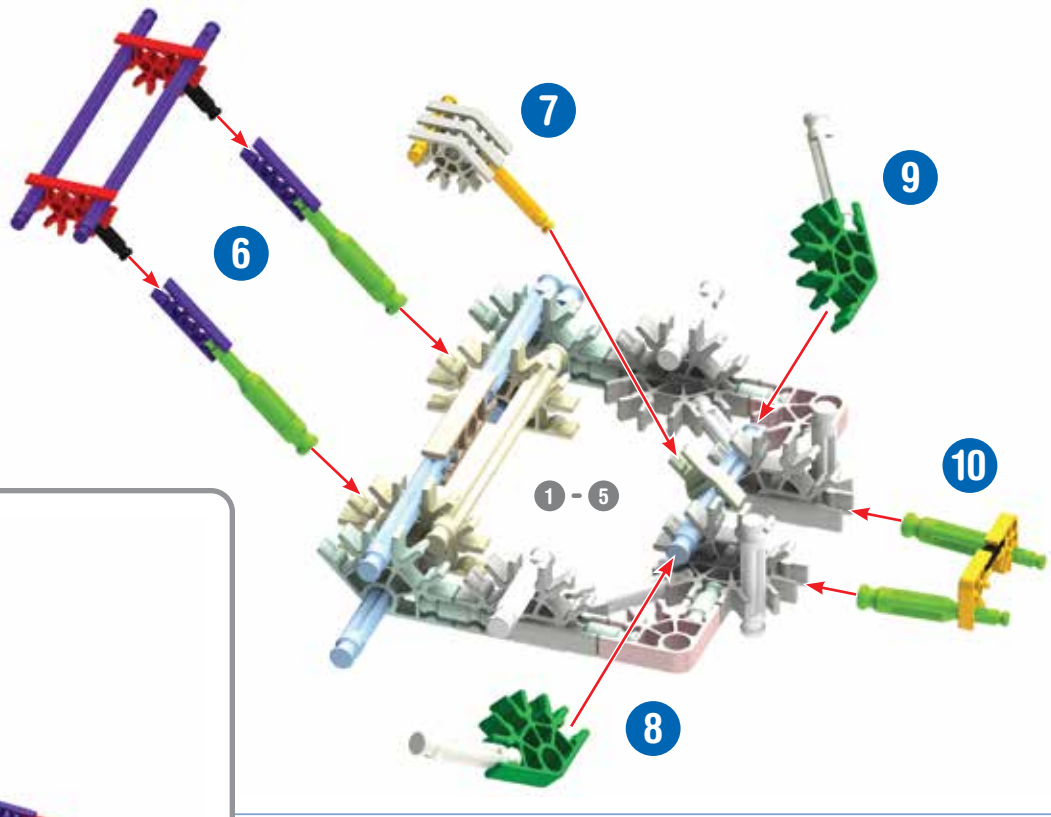

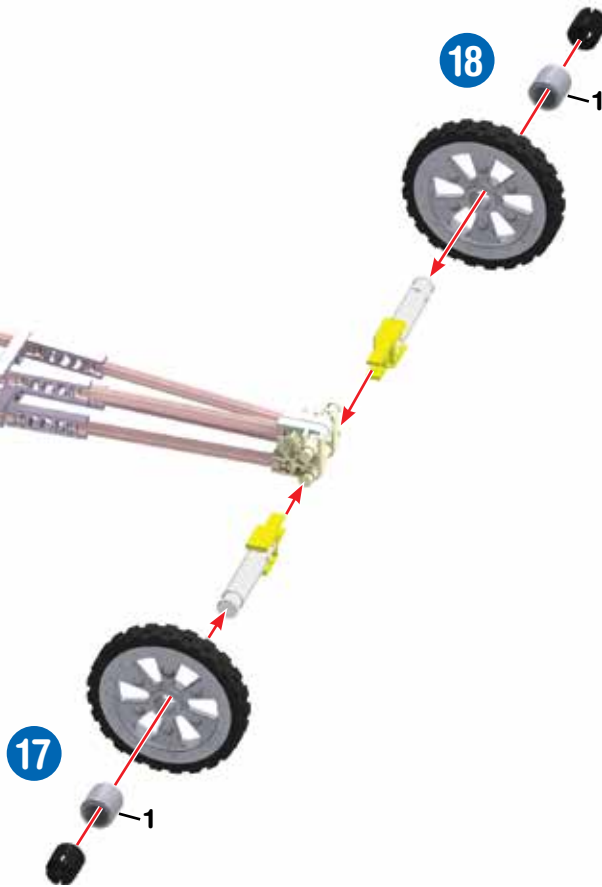
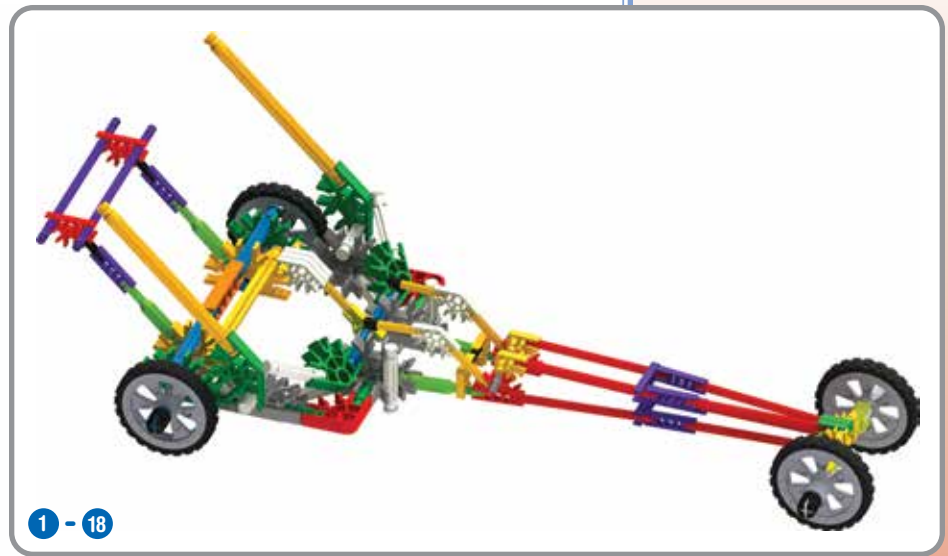
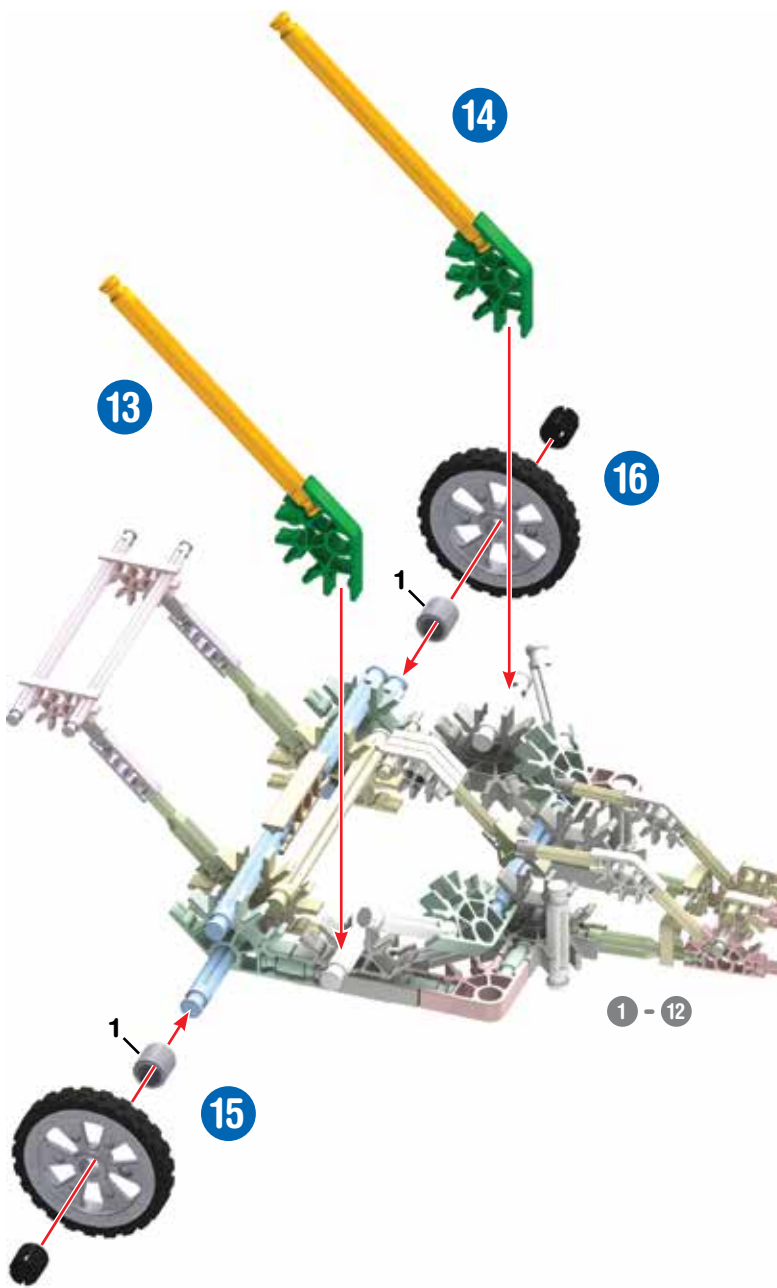



# Vintage Roadster Roadster Vintage

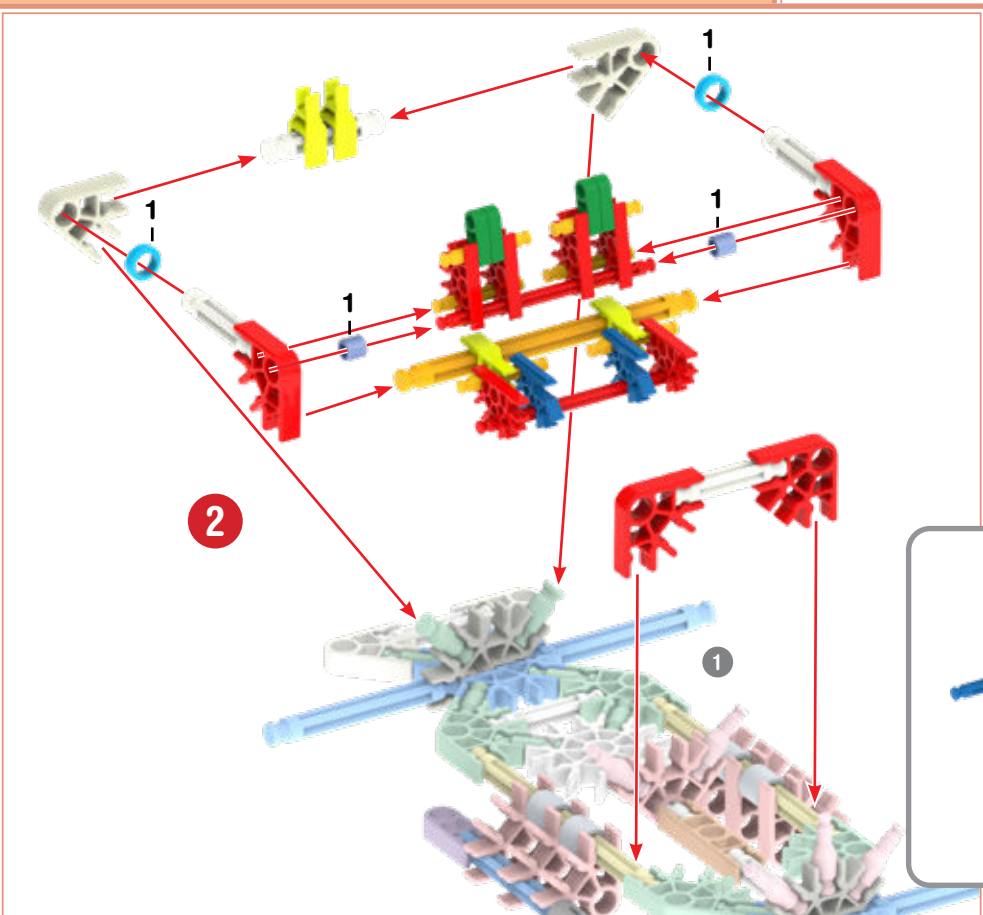
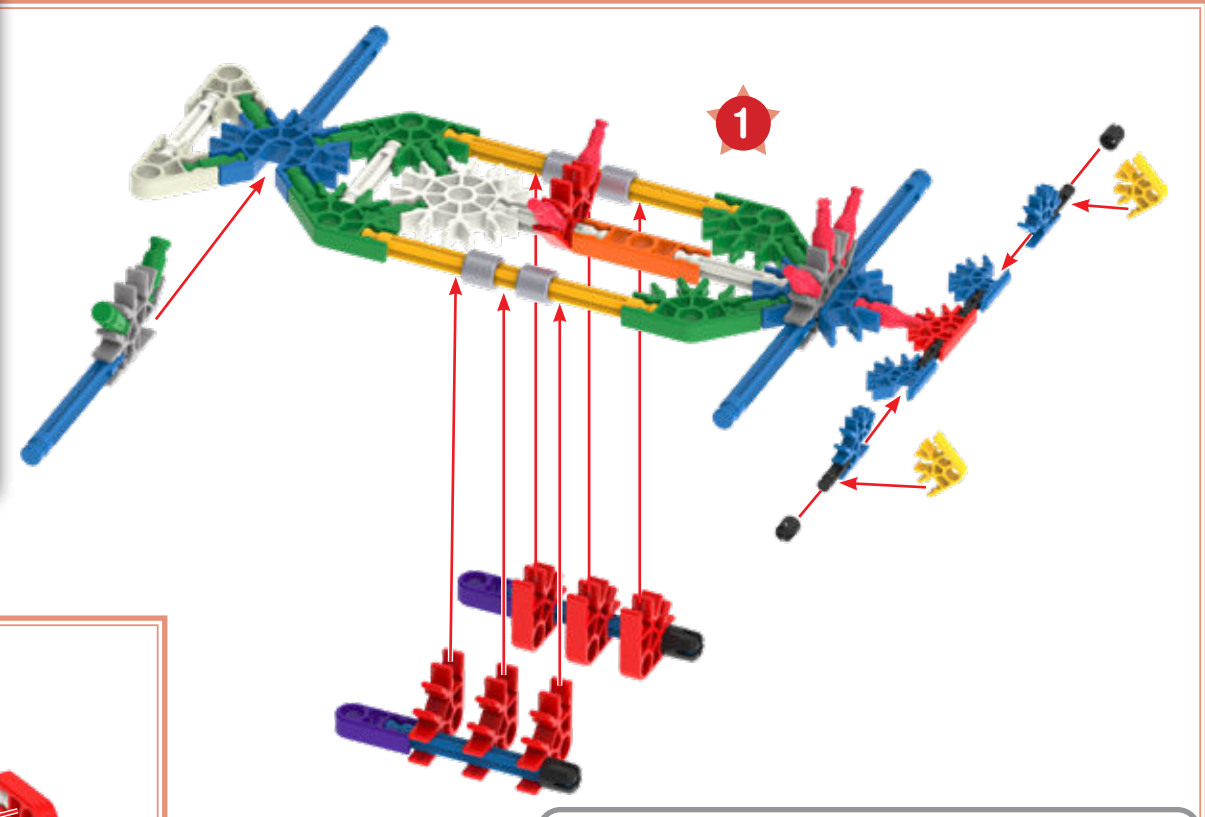

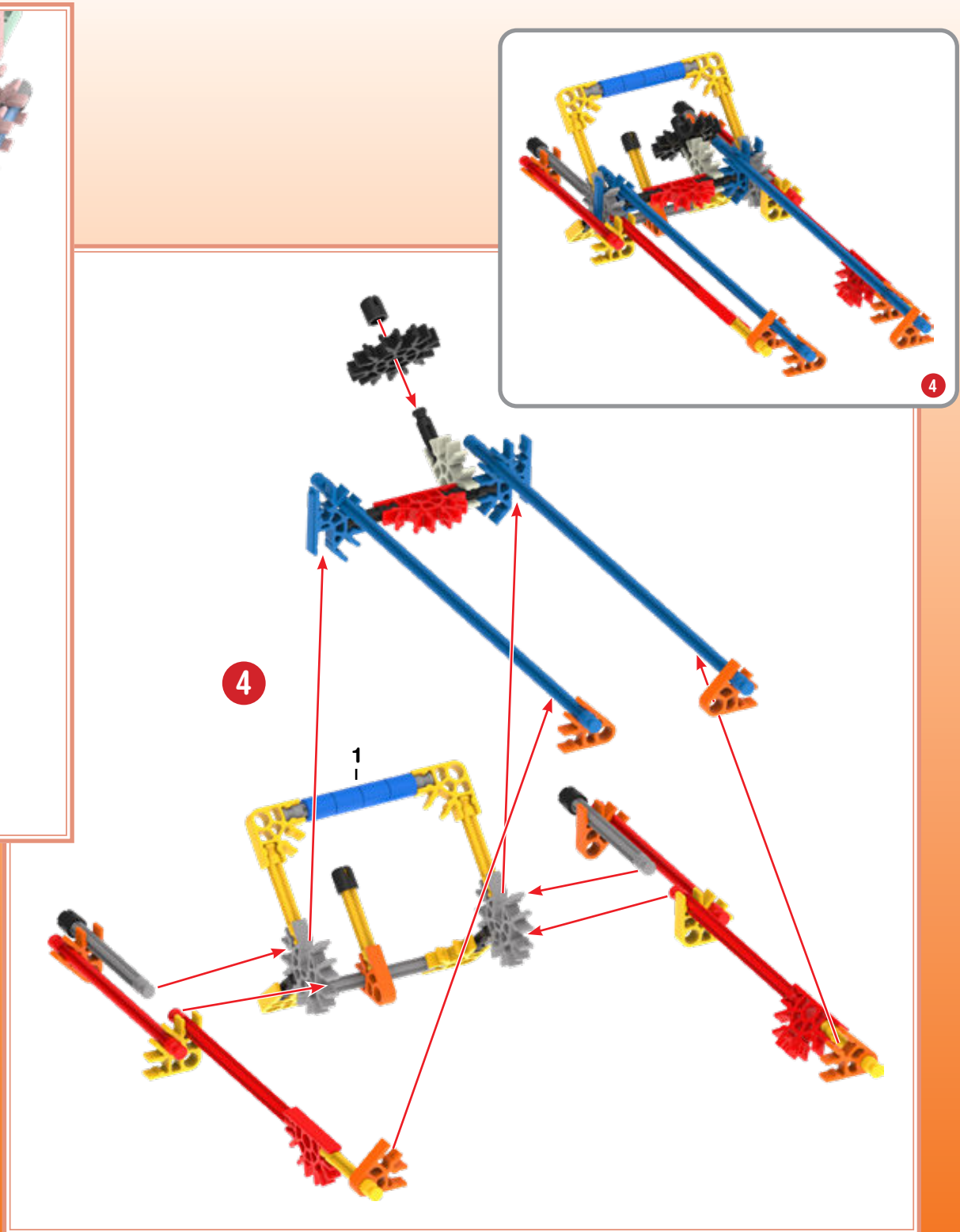
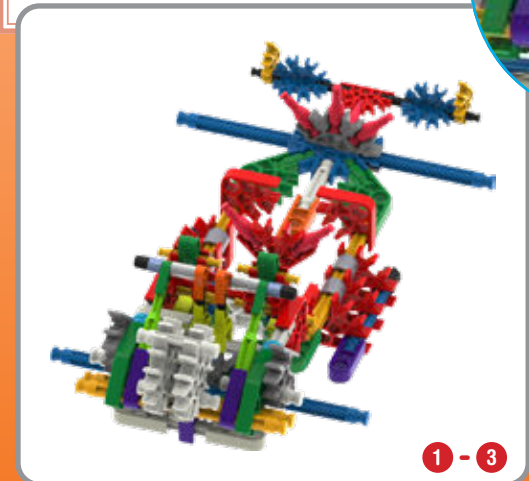
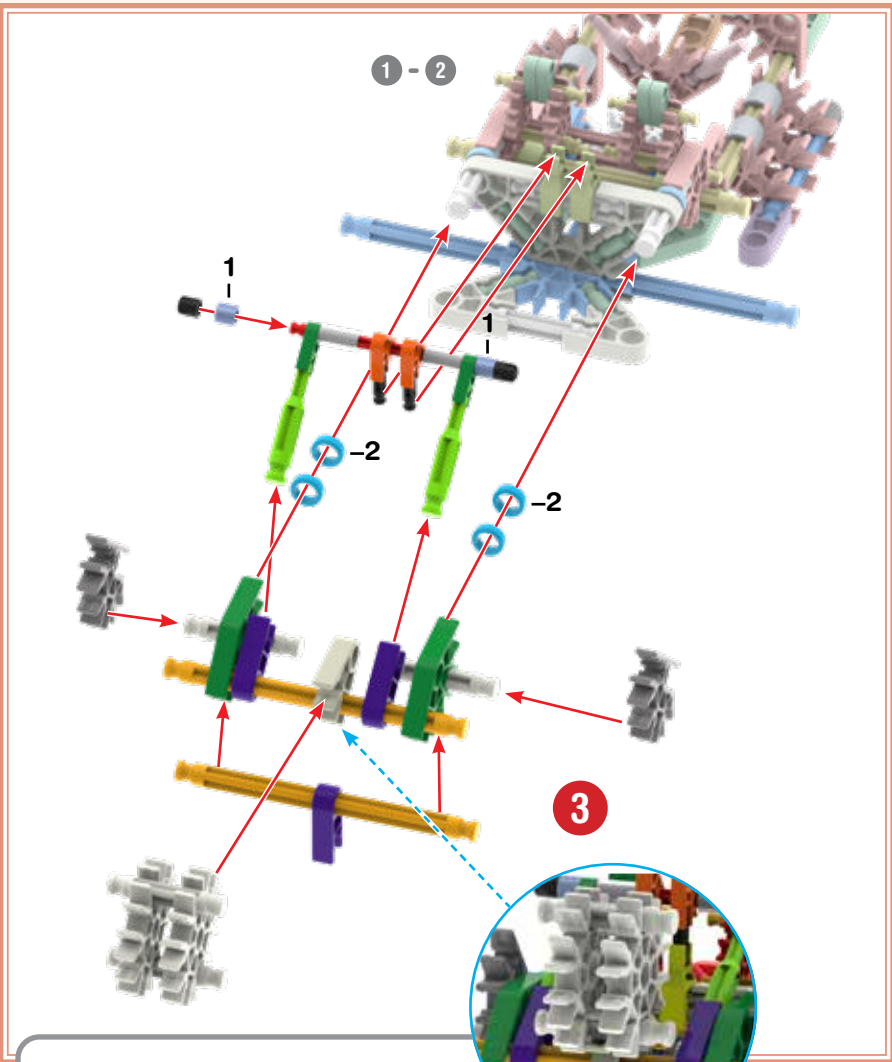

5

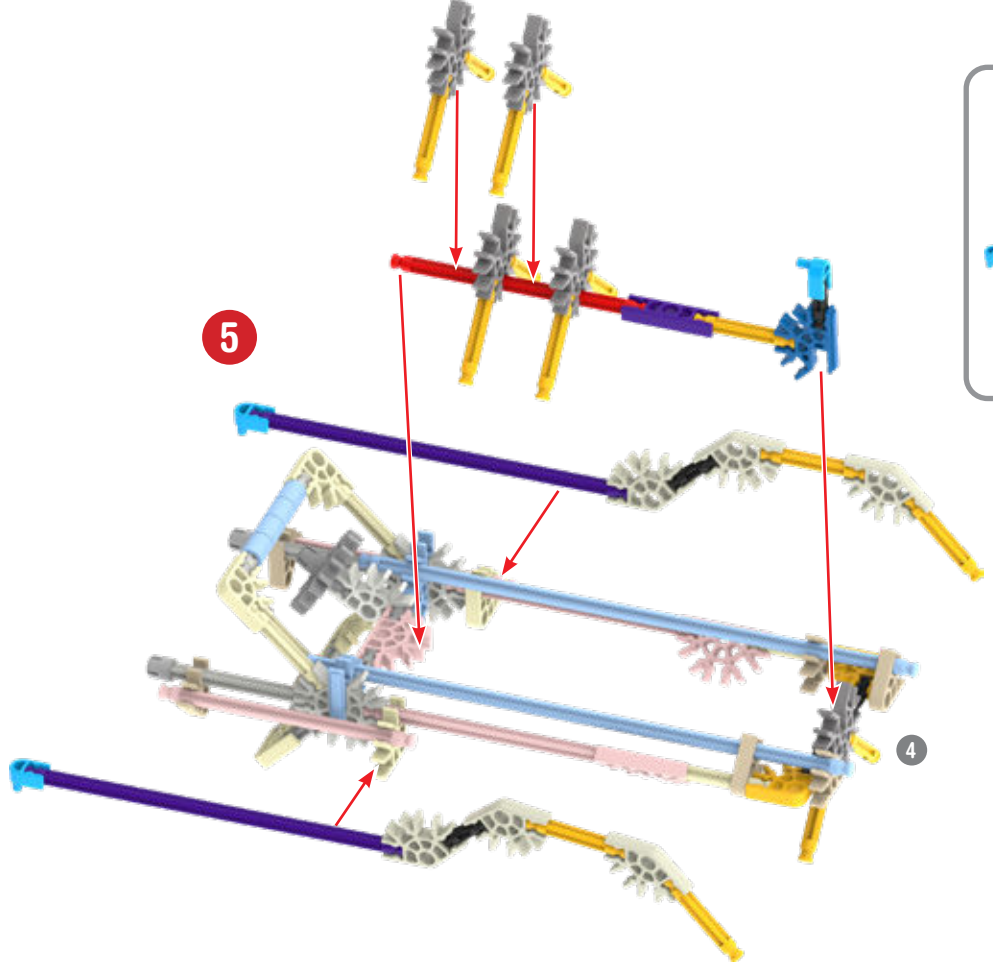

4 - 5

4

4 - 5

6

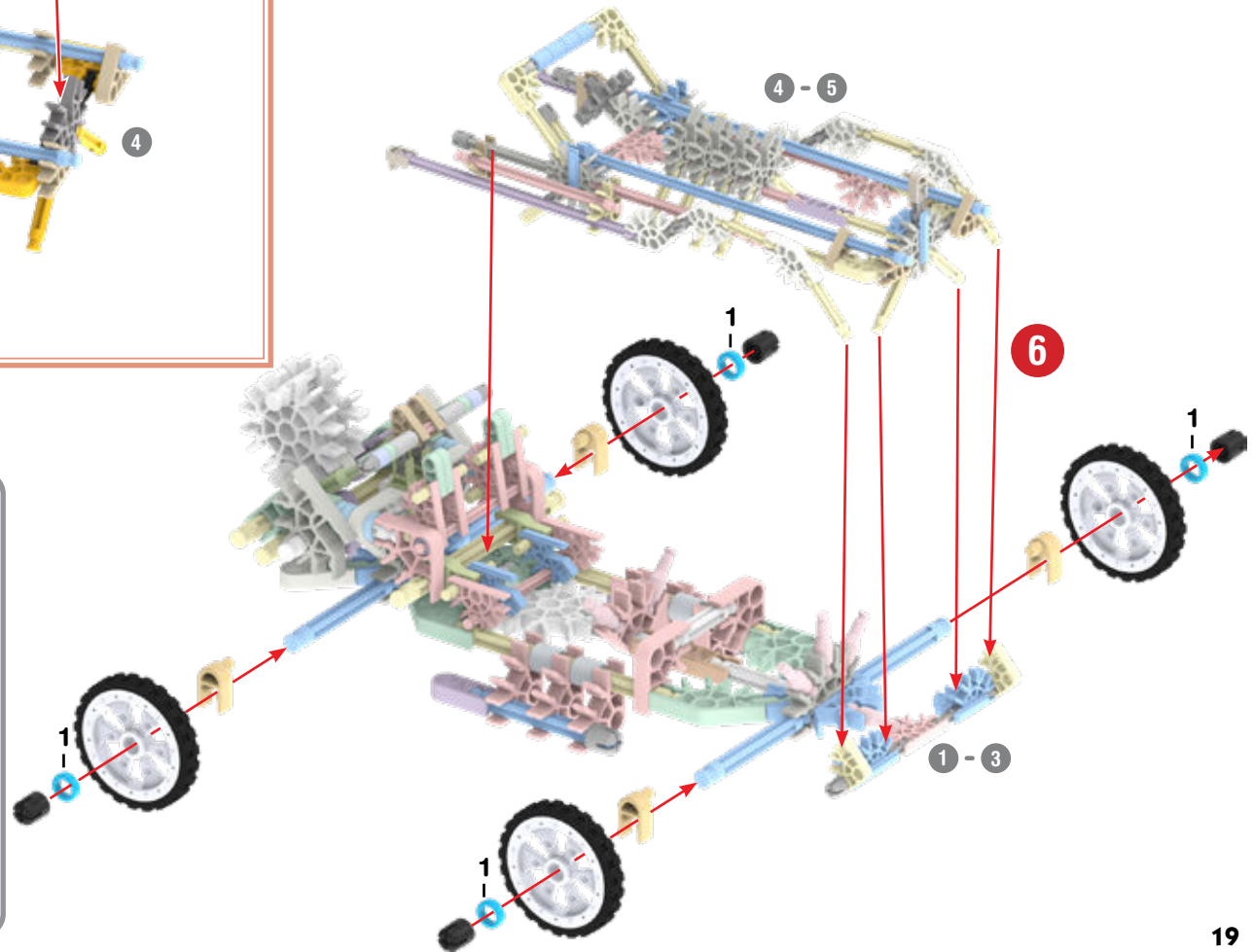

1 - 3

1

1

1



1 - 6

# Dump Truck Camion-vidage

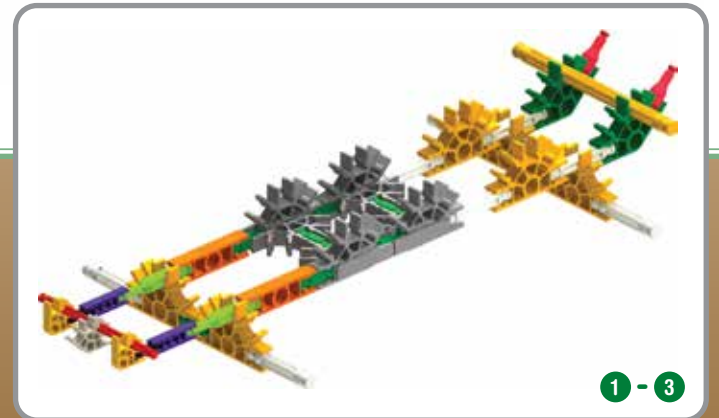
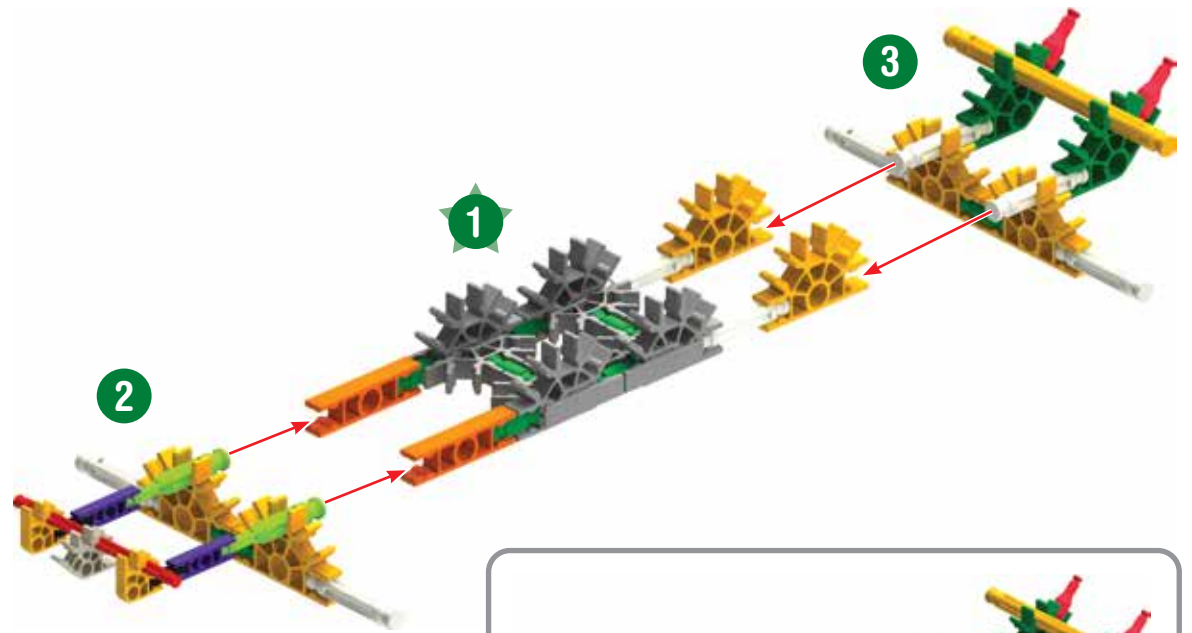

1 - 3

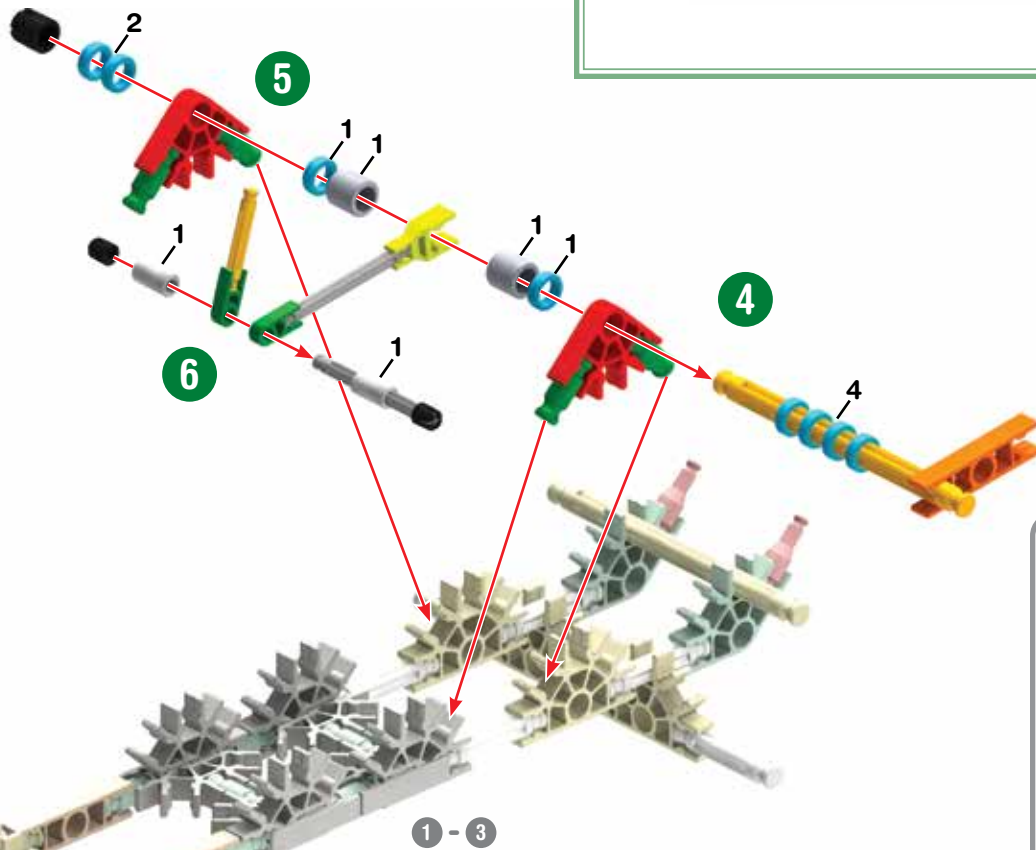

1 - 3



1 - 6

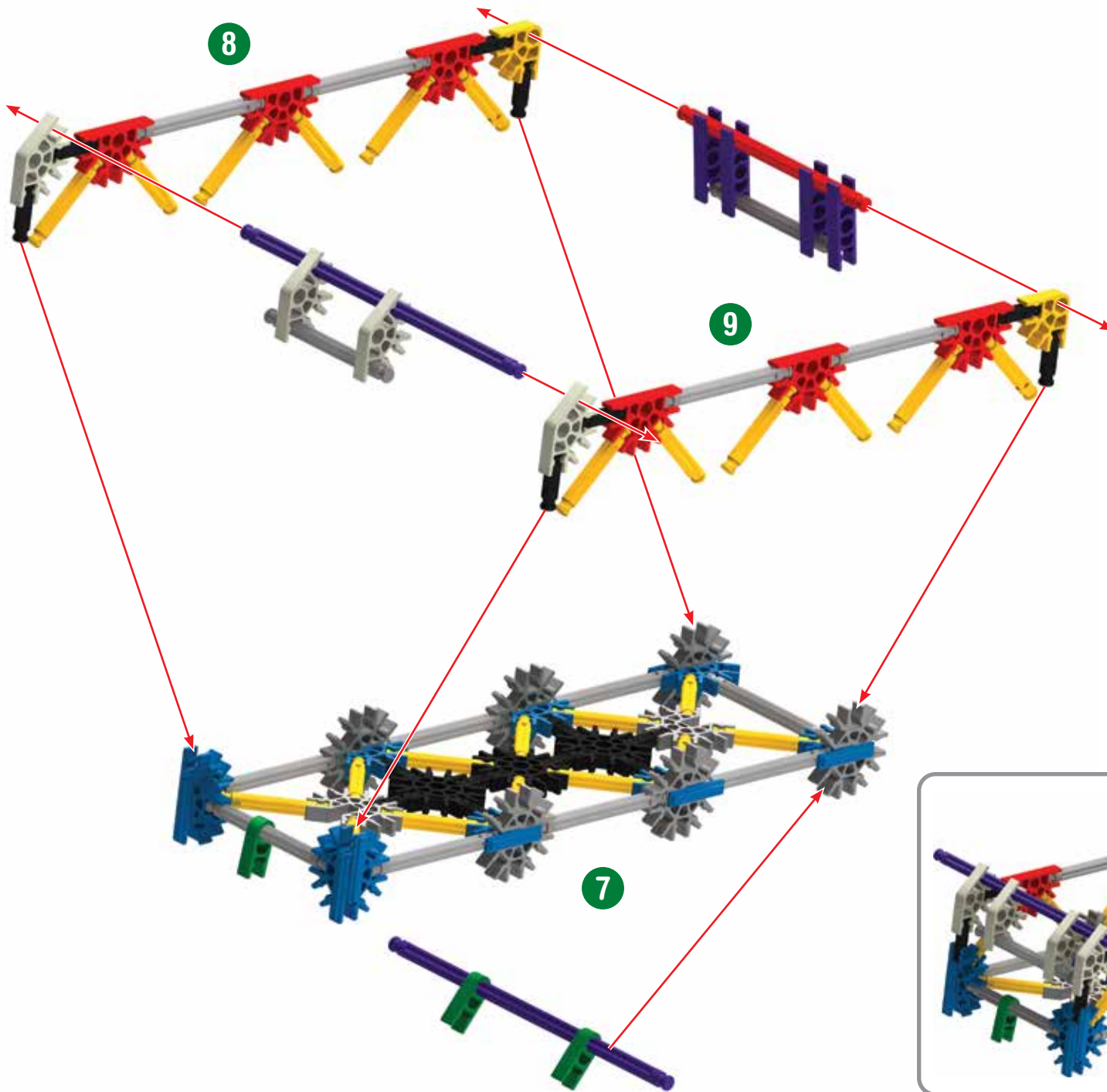

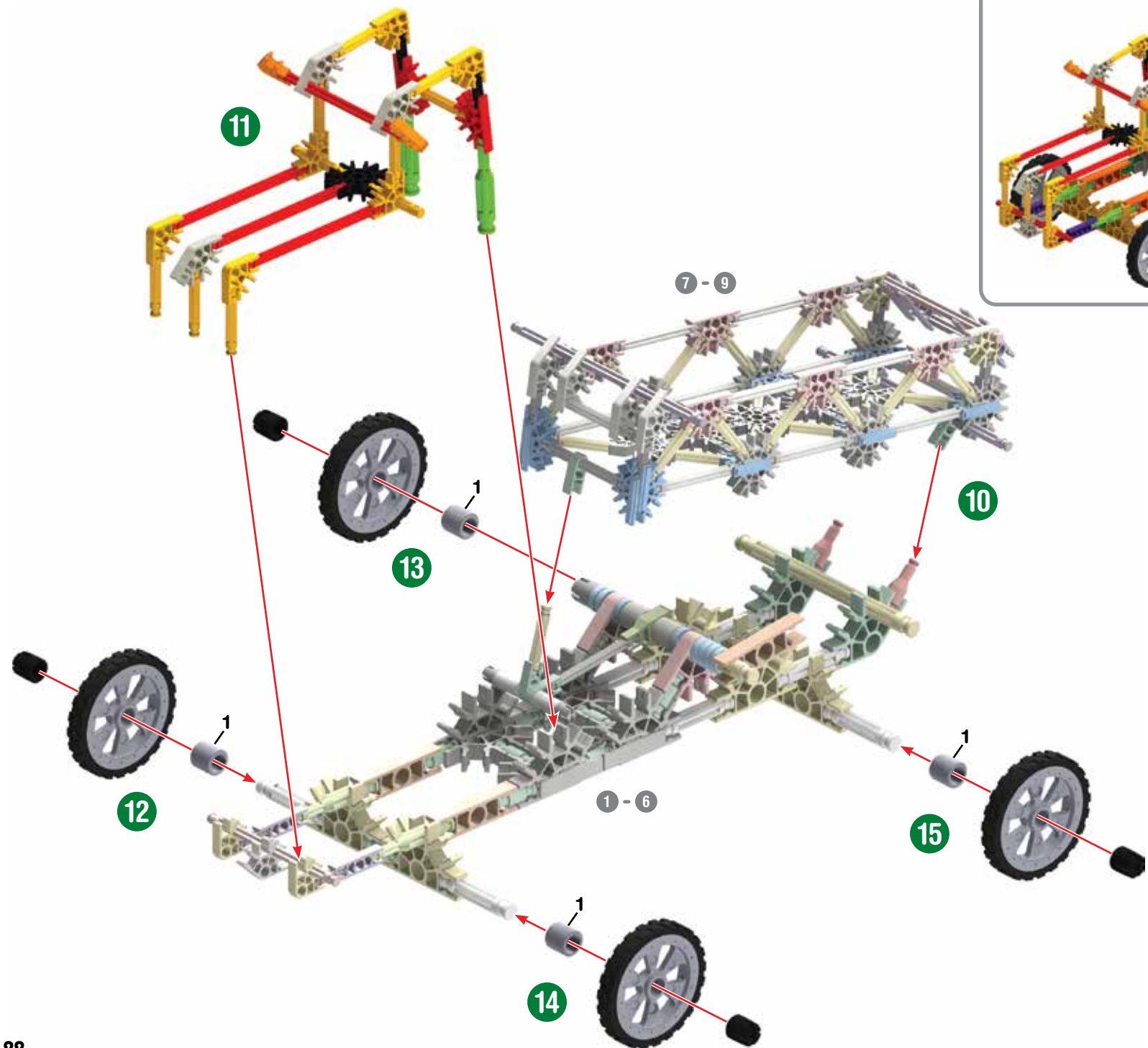

1 - 15

## BUILDING IDEAS

For instructions of these models go to  
[www.basicfun.com/knex-instructions](http://www.basicfun.com/knex-instructions) and enter code **12423**

## IDÉE DE CONSTRUCTION

Car les instructions de ces modèles vont à  
[www.basicfun.com/knex-instructions](http://www.basicfun.com/knex-instructions) et entrez dans le code **12423**

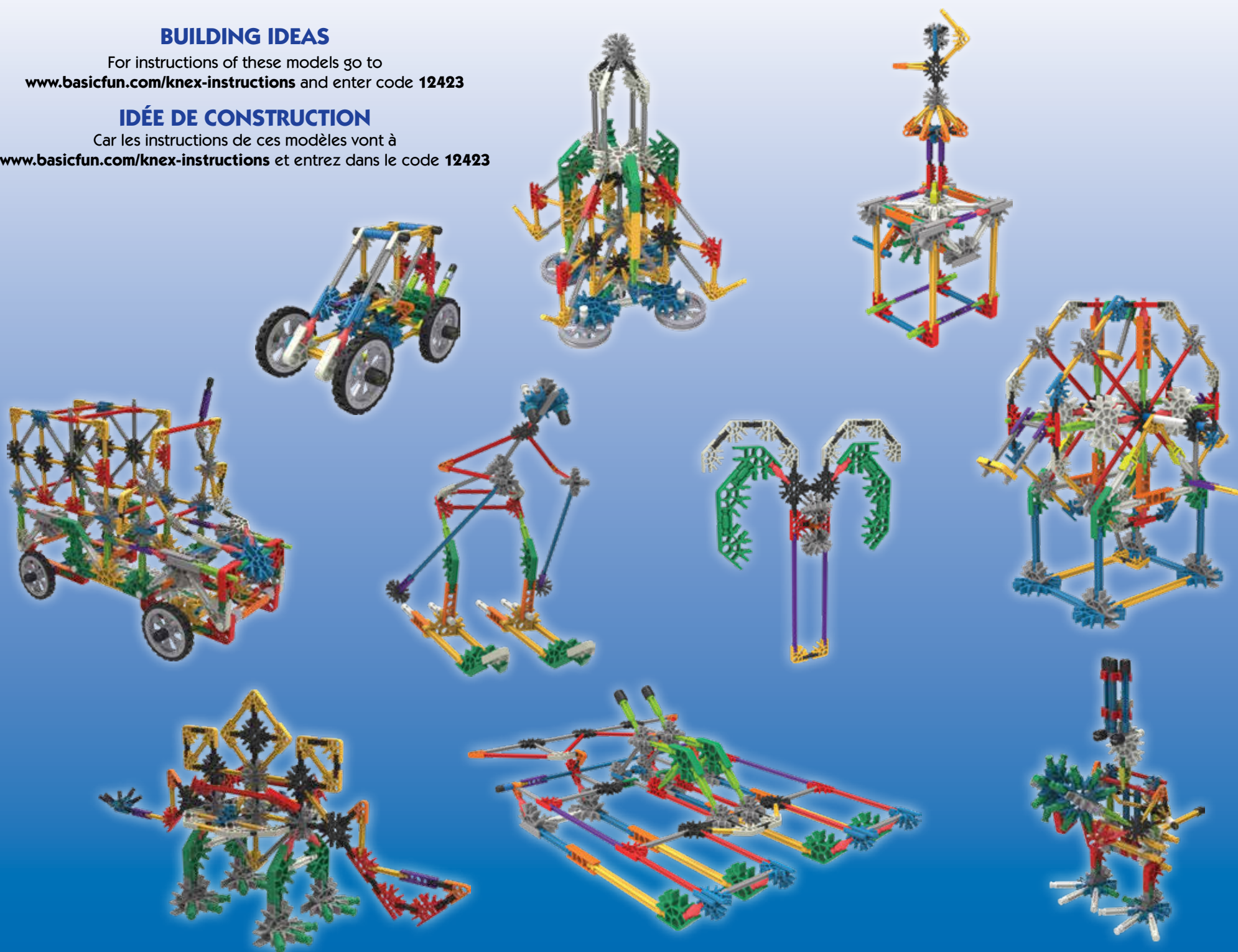

## BUILDING IDEAS

For instructions of these models go to  
[www.basicfun.com/knex-instructions](http://www.basicfun.com/knex-instructions) and enter code **12423**

## IDÉE DE CONSTRUCTION

Car les instructions de ces modèles vont à  
[www.basicfun.com/knex-instructions](http://www.basicfun.com/knex-instructions) et entrez dans le code **12423**

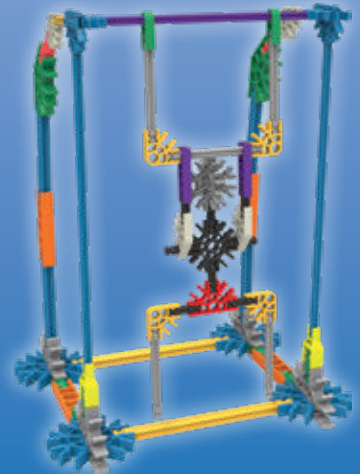
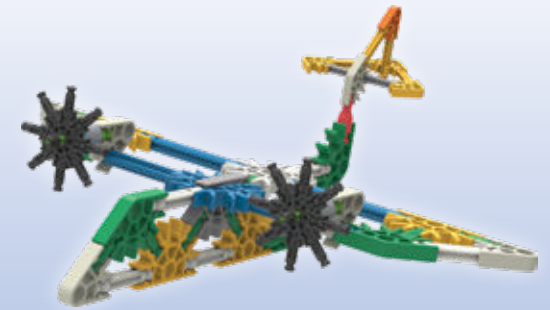



## BUILDING IDEAS

For instructions of these models go to  
[www.basicfun.com/knex-instructions](http://www.basicfun.com/knex-instructions) and enter code **12423**

## IDÉE DE CONSTRUCTION

Car les instructions de ces modèles vont à  
[www.basicfun.com/knex-instructions](http://www.basicfun.com/knex-instructions) et entrez dans le code **12423**

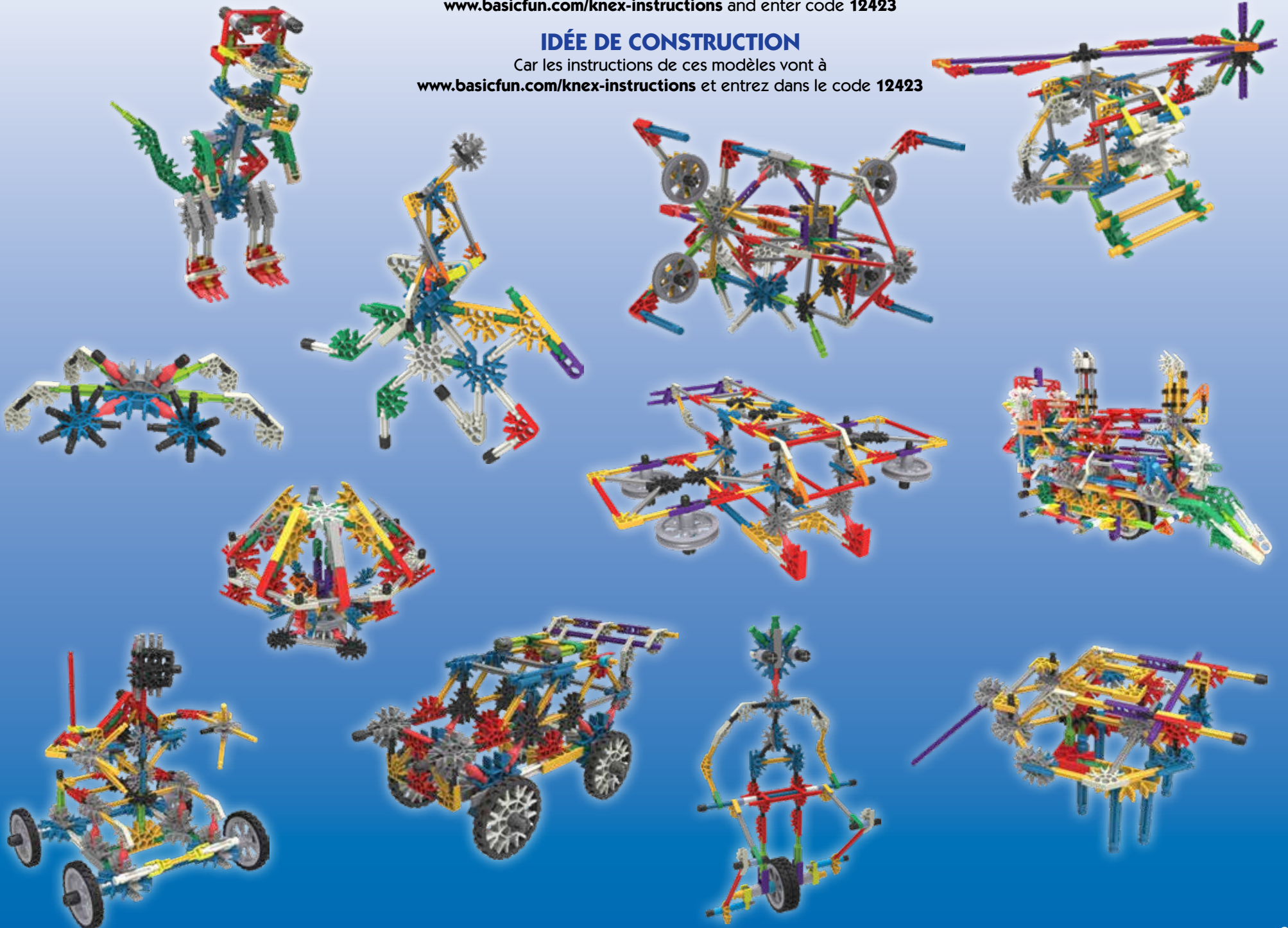

(ES) Español

(Página 2)

## Lista de piezas

Antes de comenzar a construir, compare las piezas de su juego con las que se enumeran aquí. Si falta algo, visite [www.Basicfun.com](http://www.Basicfun.com) para contactarnos. ¡Estamos aquí para ayudarte!

## Esenciales de construcción K'NEX

### Para comenzar a construir

Para comenzar el modelo, encuentre el número 1 del paso y siga los números. Cada pieza tiene su propia forma y color. Observe las imágenes, encuentre las piezas que sean iguales a las que se muestran y conéctelas. Colocar el modelo en la misma dirección que se encuentra en las instrucciones le facilitará la construcción. Las flechas muestran en dónde se conectan las piezas, pero no todos los puntos de conexión tienen flechas. Las partes de color tenue son las que ya armó.

### Separadores

Hay sitios en el modelo en los que necesita utilizar separadores. Asegúrese de usar el número correcto de separadores que se muestra en las instrucciones.

### Conectores

Puede unir estos conectores especiales deslizándolos Presione con fuerza hasta que oiga un "clic". Preste especial atención a las instrucciones y colóquelos de forma horizontal o vertical, exactamente como se muestra.

(DE) Deutsch

(Seite 2)

## Teileliste

Bevor du mit dem Bauen anfängst, solltest du prüfen ob die Teile in deinem Bausatz mit denen auf dieser Teileliste übereinstimmen. Wenn etwas fehlt, besuchen Sie bitte [www.Basicfun.com](http://www.Basicfun.com), um uns zu kontaktieren. Wir sind hier, um dir zu helfen!

## Grundlegende Bauanleitungen für K'NEX

### Los geht's mit dem Bauen

Um mit dem Bauen deines Modells zu beginnen, suche die Nummer 1 und folge den laufenden Nummern. Jedes Teil hat seine eigene Form und Farbe. Schau dir einfach die Abbildungen an, such die Teile in deinem Bausatz, die so aussehen wie das, was du auf der Abbildung siehst und

steck sie ineinander. Versuche, dein Modell beim Zusammenbauen so zu orientieren, dass es in die gleiche Richtung weist, wie es in den Anleitungen beschrieben und gezeigt wird. Blasser Farben weisen darauf hin, dass dieser Streckenabschnitt bereits zusammengebaut ist.

### Abstandsstücke

An manchen Stellen in deinem Modell musst du Abstandsstücke einbauen. Achte darauf, die richtige Farbe und Anzahl von Abstandsstücken wie in der Anleitung gezeigt zu verwenden.

### Verbindungsstücke

Blaue und silberfarbene Verbindungsstücke haben besonders lange Schlitz. Wie du von der Abbildung sehen kannst, lassen sie sich ineinander schieben. Achte beim Aneinanderfügen dieser Teile darauf, dass du ein Klickgeräusch hörst. Erst dann sind die Teile fest miteinander verbunden.

(IT) Italiano

(Pagina 2)

## Elenco delle parti

Prima di cominciare a costruire, accertati di confrontare le parti che sono nel tuo set con l'elenco delle parti qui. Se manca qualcosa, visitare [www.Basicfun.com](http://www.Basicfun.com) per contattarci. Siamo qui per aiutarvi!

## Istruzioni di base per costruire con K'NEX

### Comincia a costruire

Per iniziare il modello, cerca il numero 1 e segui i numeri. Ogni pezzo ha una sua forma e un suo colore. Guarda la figura, trova i pezzi corrispondenti nel set e mettili insieme. Cerca di tenere il modello nella stessa direzione della figura e in tal modo sarà più semplice attaccare i pezzi nei posti giusti. I colori spenti ti dicono che questa sezione è già stata costruita. Dovrai collegare la nuova sezione al punto indicato dalla punta della freccia.

### Spaziatori

Ci sono punti nel tuo modello a cui dovrai aggiungere spaziatori blu e argento. Accertati di contarli attentamente.

### Connettori

È molto importante posizionare i connettori blu e argento in una specifica direzione. Presta molta attenzione alle istruzioni e posiziona i connettori orizzontalmente o verticalmente proprio come illustrato. Spingi con forza fino ad udire un clic.

(PT) Português

(Página 2)

## Lista das peças

Antes de começar a montar, compare as partes do seu conjunto com as partes enumeradas aqui. Se alguma coisa estiver faltando, por favor visite [www.Basicfun.com](http://www.Basicfun.com) para nos contatar. Estamos aqui para ajudá-lo!

## Instruções básicas para montar o K'NEX

### Comece a montar

Para começar a montar o modelo, encontre o número do passo e siga os números. Cada peça tem a sua própria forma e cor. Estude as ilustrações, encontre as peças que coincidem com o que você estiver vendo e conecte-as. Fique de frente para o modelo, na mesma direção que as figuras mostradas nas instruções. As setas mostram onde as peças se conectam, mas nem todos os pontos de conexão têm setas. As partes com cores desbotadas são as que você já montou.

### Separadores

Há lugares no modelo onde você precisará usar separadores. Use o número de espaçadores corretos exibidos nas instruções.

### Conectores

Você pode fazer com que estes conectores se deslizem e se conectem. Empurre até ouvir um "clique". Preste atenção às instruções e posicione-os horizontal ou verticalmente exatamente conforme a ilustração.

(NL) Nederlands

(Bladzijde 2)

## Onderdelen Lijst

Voordat u begint met bouwen, moet u de onderdelen vergelijken de set met de onderdelen lijst hier. Als er iets ontbreekt, bezoek dan [www.Basicfun.com](http://www.Basicfun.com) om contact met ons op te nemen. We zijn er om u te helpen!

## Basisstappen voor K'NEX bouwen

### Begin te bouwen

Om met je model te beginnen, vind eerst het nummer 1 en volg de nummers. Elk stuk heeft zijn eigen vorm en kleur. Kijk gewoonweg naar de afbeeldingen, vind de overeenstemmende stukken terug in je geheel en maak e aan mekaar vast. Tracht je model in dezelfde richting te plaatsen als de aanwijzingen terwijl je bouwt en monteert. De vervaagde kleuren duiden aan dat dit deel reeds is opgebouwd. Gelieve het nieuwe deel vast te koppelen op de plaats aangeduid door de pijlen.

### Tussenstukken

In je model zijn er plaatsen waar blauwe en zilveren tussenstukken moeten toegevoegd worden. Verzeker je ervan de juiste kleur te gebruiken en tel ze zorgvuldig.

### Koppelstukken

Er zijn blauwe en zilveren koppelstukken met speciale lange gleuven. Ze schuiven in mekaar zoals je kunt zien op de afbeeldingen. Duw deze onderdelen in mekaar tot je een "klik" hoort.



**basicfun.com**



@knex



facebook.com/knex

©2021 Basic Fun, Inc., 301 Yamato Road, Suite 4200, Boca Raton FL 33431. USA. All rights reserved. Tous droits réservés. Todos los derechos reservados. K'NEX UK Ltd., 200 Brook Drive, Green Park, Reading, RG6 2UB England.

Basic Fun products are safety tested and comply with ASTM F963. Les produits Basic Fun sont soumis à des test de sécurité et sont conformes à la ASTM F963. Los productos Basic Fun están probados de seguridad y cumplen con ASTM F963.

K'NEX is registered trademark and the Basic Fun logo is a trademark of Basic Fun, Inc. K'NEX est une marque déposée et le logo Basic Fun est une marque commerce de Basic Fun, Inc. K'NEX es una marca registrada y el logotipo de Basic Fun es una marca de Basic Fun, Inc.

(EN) WARNING: CHOKING HAZARD

Small parts. Not for children under 3 years.

Product & colors may vary. Most models can be built one at a time.

(FR) ATTENTION: RISQUE D'ÉTOUFFEMENT

Pièces de petite taille. Ne convient pas aux enfants de moins de 3 ans.

Le produit et ses couleurs peuvent varier. Les différents modèles ne peuvent être construits qu'un par un.

(ES) ADVERTENCIA: PELIGRO DE ASFIXIA

Piezas pequeñas. No para niños menores de 3 años.

El producto y los colores pueden variar. La mayoría de los modelos se pueden construir uno a la vez.

(DE) ACHTUNG: ERSTICKUNGSGEFAHR

Kleinteile. Nicht geeignet für Kinder unter 3 Jahren.

Produkte und Farben können abweichen. Die meisten Modelle können immer nur einzeln gebaut werden.

(IT) AVVISO: PERICOLO DI SOFFOCARE

Pezzi piccoli. Non adatto per bambini sotto 3 anni.

Prodotti e colori possono differire. La maggior parte dei modelli si può costruire autonomamente.

(PT) AVISO: PERIGO DE SUFOCAÇÃO

Peças pequenas. Não se destina a crianças com menos de 3 anos de idade.

O produto e as cores podem variar. A maioria dos modelos pode ser montado um de cada vez.

(NL) WAARSCHUWING: VERSTIKKINGSGEVAAR

Kleine onderdelen. Niet geschikt voor kinderen jonger dan 3 jaar.

Product en kleuren kunnen variëren. De meeste modellen kunnen uitsluitend een voor een worden gebouwd.